



# AAT3220 150mA NanoPower™ LDO Linear Regulator

**PowerLinear™**

## General Description

The AAT3220 PowerLinear™ NanoPower Low Dropout Linear Regulator is ideal for portable applications where extended battery life is critical. This device features extremely low quiescent current which is typically 1.1µA. Dropout voltage is also very low, typically less than 225mV at the maximum output current of 150mA. The AAT3220 has output short circuit and over current protection. In addition, the device also has an over temperature protection circuit, which will shutdown the LDO regulator during extended over current events.

The AAT3220 is available in a space saving SOT-23 package or a SOT-89 for applications requiring increased power dissipation. The device is rated over a -40°C to 85°C temperature range. Since only a small, 1µF ceramic output capacitor is required, often the only space used is that occupied by the AAT3220 itself. The AAT3220 is truly a compact and cost effective voltage conversion solution.

The AAT3221/2 is a similar product for this application, especially when a shutdown mode is required for further power savings.

## Features

- 1.1 µA Quiescent Current
- Low Dropout: 200 mV (typ)
- Guaranteed 150mA Output
- High accuracy: ±2.0%
- Current limit protection
- Over-Temperature protection
- Low Temperature Coefficient
- Factory programmed output voltages: 1.8V to 3.5V
- Stable operation with virtually any output capacitor type
- 3-pin SOT-89 and SOT-23 packages
- 4kV ESD Rating

## Applications

- Cellular Phones
- Notebook Computers
- Portable Communication Devices
- Handheld Electronics
- Remote Controls
- Digital Cameras
- PDAs

## Typical Application

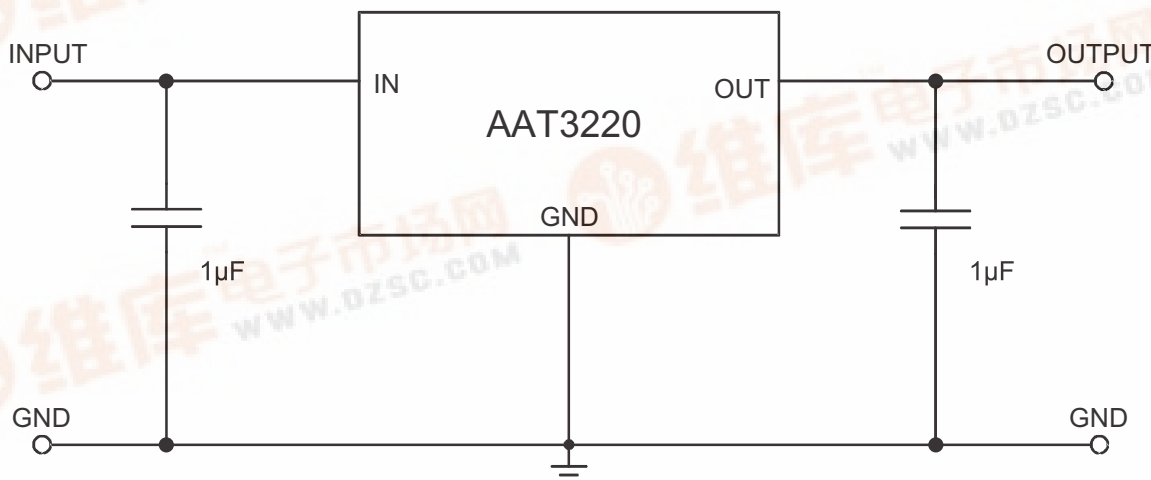

## Pin Descriptions

Pin #		Symbol	Function
SOT23-3	SOT-89		
1	1	GND	Ground connection
3	2	$V_{IN}$	Input - should be decoupled with 1 $\mu$ F or greater capacitor
2	3	OUT	Output - should be decoupled with 1 $\mu$ F or greater output capacitor
N/A	N/A	NC	Not connected

## Pin Configuration

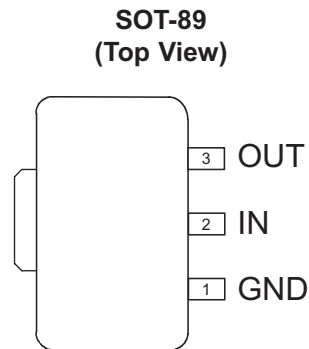
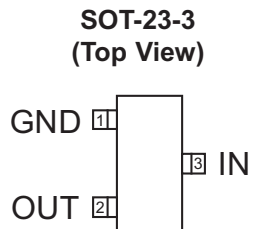

### Absolute Maximum Ratings (T<sub>A</sub>=25°C unless otherwise noted)

Symbol	Description	Value	Units
V <sub>IN</sub>	Input Voltage	-0.3 to 6	V
I <sub>OUT</sub>	DC Output Current	P <sub>D</sub> /(V <sub>IN</sub> -V <sub>O</sub> )	mA
T <sub>J</sub>	Operating Junction Temperature Range	-40 to 150	°C
T <sub>LEAD</sub>	Maximum Soldering Temperature (at leads, 10 sec)	300	°C
V <sub>ESD</sub>	ESD Rating <sup>1</sup> — HBM	4000	V

Note: Stresses above those listed in Absolute Maximum Ratings may cause permanent damage to the device. Functional operation at conditions other than the operating conditions specified is not implied. Only one Absolute Maximum rating should be applied at any one time.

Note 1: Human body model is a 100pF capacitor discharged through a 1.5kΩ resistor into each pin.

### Thermal Information

Symbol	Description	Rating	Units
Θ <sub>JA</sub>	Maximum Thermal Resistance (SOT-23-3) <sup>2</sup>	200	°C/W
	Maximum Thermal Resistance (SOT-89) <sup>2</sup>	50	°C/W
P <sub>D</sub>	Maximum Power Dissipation (SOT-23-3) <sup>2</sup>	500	mW
	Maximum Power Dissipation (SOT-89) <sup>2</sup>	2	W

Note 2: Mounted on a demo board.

### Recommended Operating Conditions

Symbol	Description	Rating	Units
V <sub>IN</sub>	Input Voltage	(V <sub>OUT</sub> +0.34) to 5.5	V
T	Ambient Temperature Range	-40 to +85	°C

**Electrical Characteristics** ( $V_{IN}=V_{OUT(NOM)}+1V$ ,  $I_{OUT}=1mA$ ,  $C_{OUT}=1\mu F$ ,  $T_A=25^\circ C$  unless otherwise noted)

Symbol	Description	Conditions	Min	Typ	Max	Units
$V_{OUT}$	DC Output Voltage Tolerance		-2.0		2.0	%
$I_{OUT}$	Output Current	$V_{OUT} > 1.2V$	150			mA
$I_{SC}$	Short Circuit Current	$V_{OUT} < 0.4V$		350		mA
$I_Q$	Ground Current	$V_{IN} = 5V$ , no load		1.1	2.5	$\mu A$
$\Delta V_{OUT}/V_{OUT}$	Line Regulation	$V_{IN} = 4.0-5.5V$		0.15	0.4	%/V
$\Delta V_{OUT}/V_{OUT}$	Load Regulation	$I_L=1$ to 100mA	$V_{OUT} = 1.8$	1.0	1.65	%
			$V_{OUT} = 2.0$	0.9	1.60	
			$V_{OUT} = 2.3$	0.8	1.45	
			$V_{OUT} = 2.4$	0.8	1.40	
			$V_{OUT} = 2.5$	0.8	1.35	
			$V_{OUT} = 2.7$	0.7	1.25	
			$V_{OUT} = 2.8$	0.7	1.20	
			$V_{OUT} = 2.85$	0.7	1.20	
			$V_{OUT} = 3.0$	0.6	1.15	
			$V_{OUT} = 3.3$	0.5	1.00	
$V_{DO}$	Dropout Voltage <sup>1</sup>	$I_{OUT} = 100mA$	$V_{OUT} = 1.8$	290	340	mV
			$V_{OUT} = 2.0$	265	315	
			$V_{OUT} = 2.3$	230	275	
			$V_{OUT} = 2.4$	220	265	
			$V_{OUT} = 2.5$	210	255	
			$V_{OUT} = 2.7$	200	240	
			$V_{OUT} = 2.8$	190	235	
			$V_{OUT} = 2.85$	190	230	
			$V_{OUT} = 3.0$	190	225	
			$V_{OUT} = 3.3$	180	220	
$V_{OUT} = 3.5$	180	220				
PSRR	Power Supply Rejection Ratio	100 Hz		50		dB
$T_{SD}$	Over Temp Shutdown Threshold			140		$^\circ C$
$T_{HYS}$	Over Temp Shutdown Hysteresis			20		$^\circ C$
$e_N$	Output Noise	10 Hz through 10 kHz		350		$\mu V$
$T_C$	Output Voltage Temp. Coeff.			80		ppm/ $^\circ C$

Note 1:  $V_{DO}$  is defined as  $V_{IN} - V_{OUT}$  when  $V_{OUT}$  is 98% of nominal.

### Typical Characteristics

(Unless otherwise noted:  $V_{IN} = V_{OUT} + 1V$ ,  $T_A = 25^\circ C$ , Output capacitor is 1  $\mu F$  ceramic,  $I_{OUT} = 40 mA$ )

**Output Voltage v. Output Current**

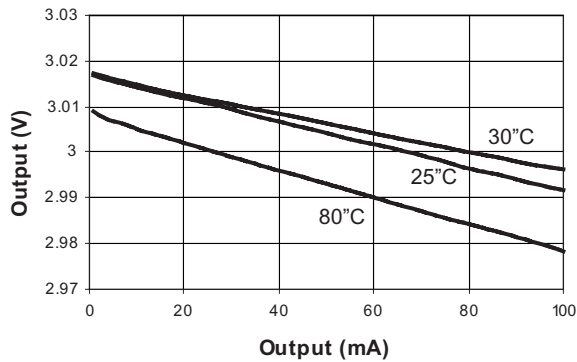

**Output Voltage v. Input Voltage**

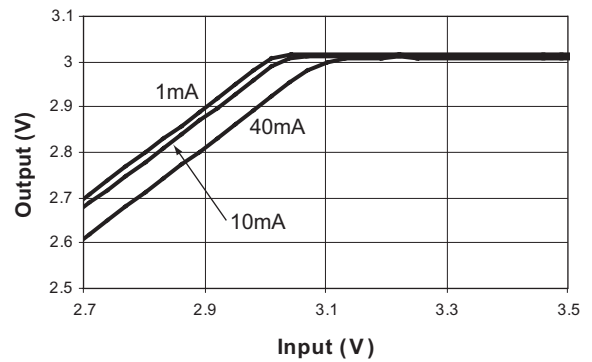

**Output Voltage v. Input Voltage**

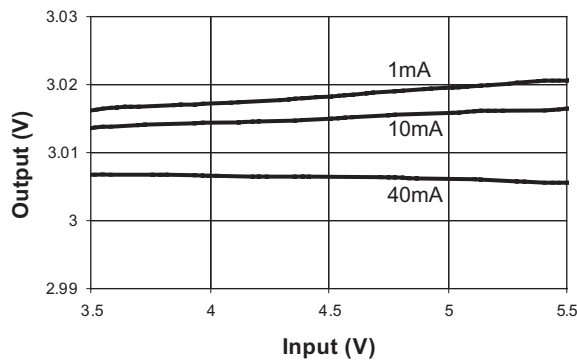

**Drop-out Voltage v. Output Current**

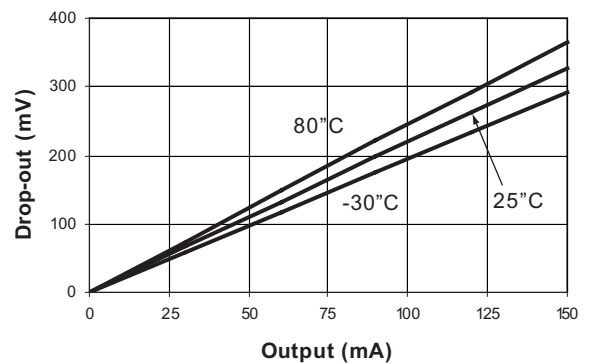

**Supply Current v. Input Voltage**

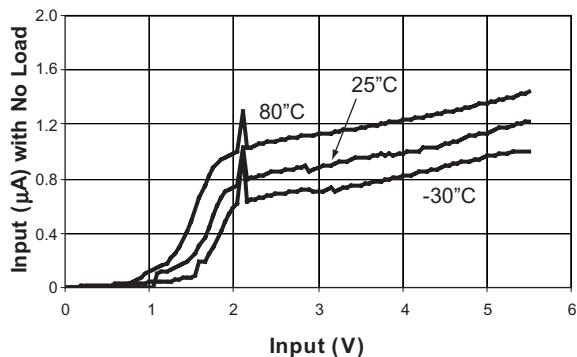

**PSRR with 10mA Load**

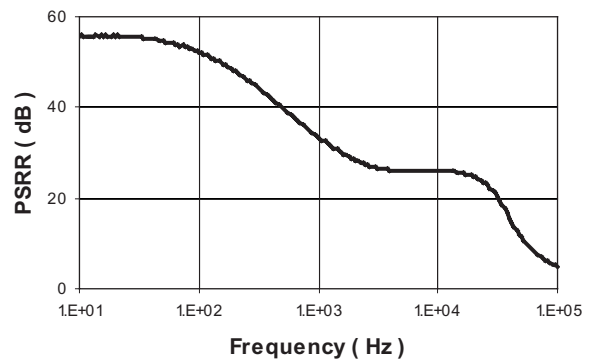

(Unless otherwise noted:  $V_{IN} = V_{OUT} + 1V$ ,  $T_A = 25^\circ C$ , Output capacitor is 1  $\mu F$  ceramic,  $I_{OUT} = 40 mA$ )

**AAT3220 Noise Spectrum**

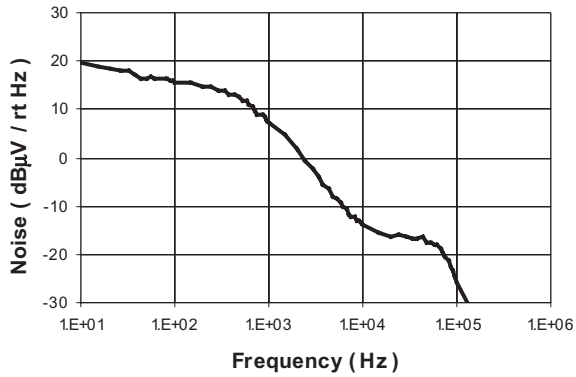

**Line Response with 1mA Load**

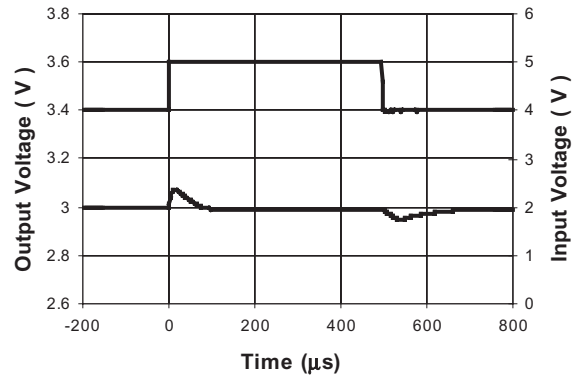

**Line Response with 10mA Load**

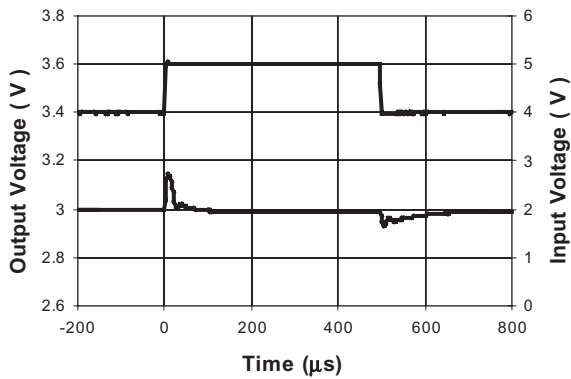

**Line Response with 100mA Load**

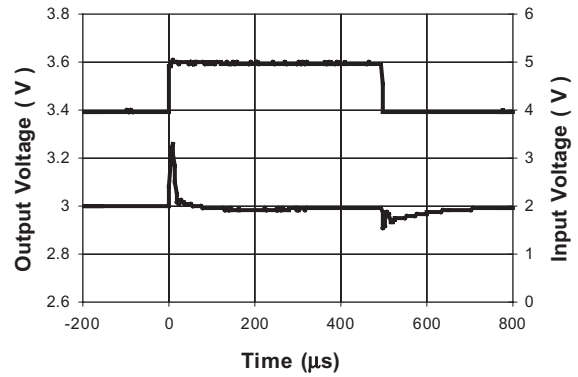

**Load Transient - 1 mA / 40 mA**

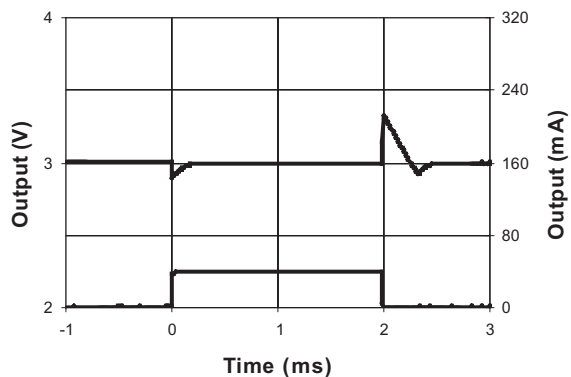

**Load Transient - 1 mA / 80 mA**

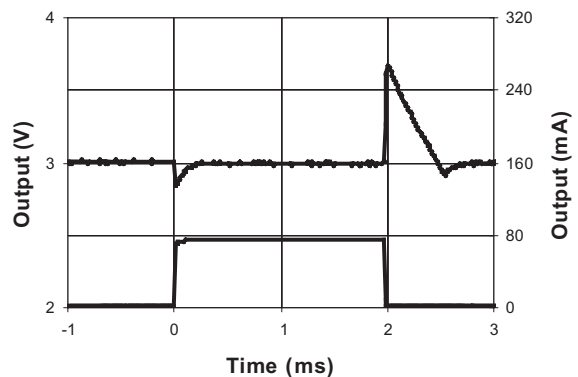

(Unless otherwise noted:  $V_{IN} = V_{OUT} + 1V$ ,  $T_A = 25^\circ C$ , Output capacitor is  $1 \mu F$  ceramic,  $I_{OUT} = 40 \text{ mA}$ )

**Power Up with 1mA Load**

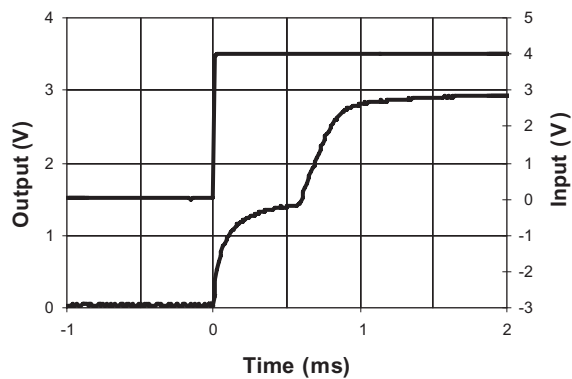

**Power Up with 10mA Load**

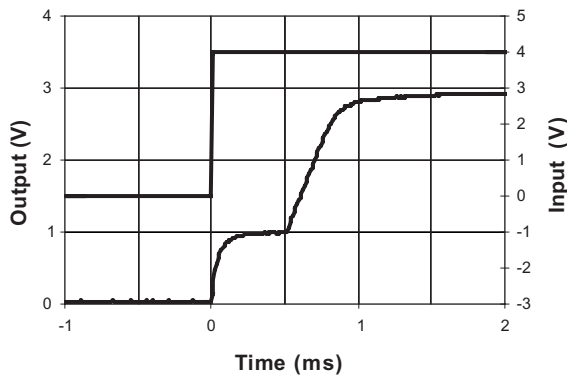

**Power Up with 100mA Load**

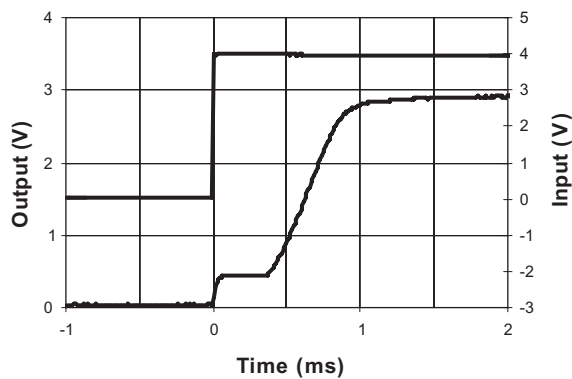

## Functional Block Diagram

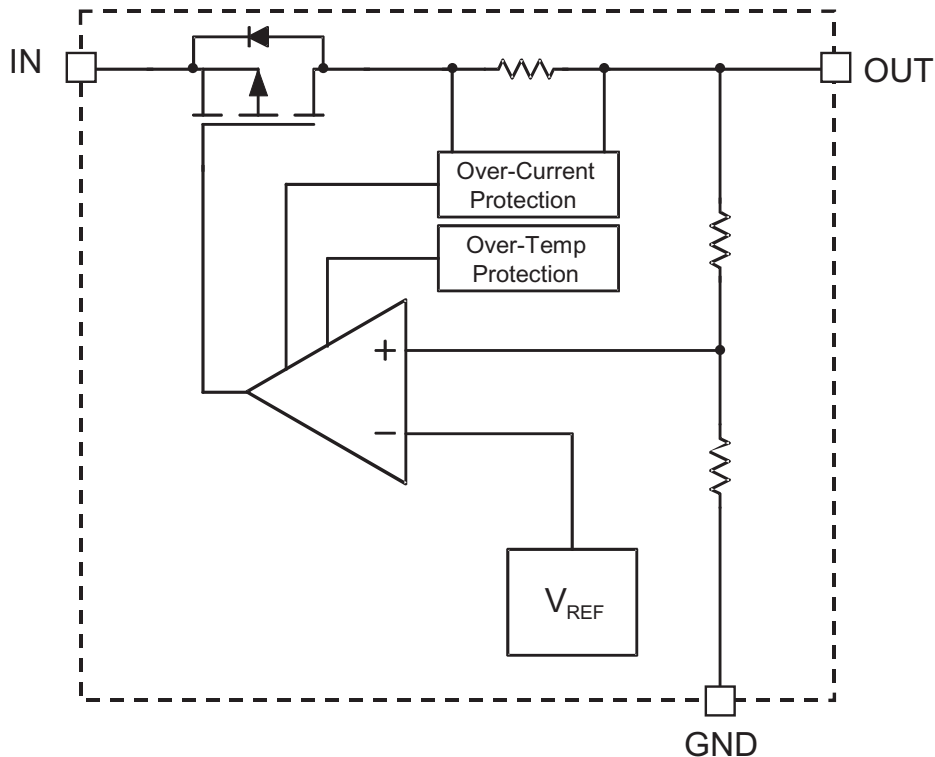

## Functional Description

The AAT3220 is intended for LDO regulator applications where output current load requirements range from No Load to 150mA.

The advanced circuit design of the AAT3220 has been optimized for minimum quiescent or ground current consumption making it ideal for use in power management systems for small battery operated devices. The typical quiescent current level is just 1.1 $\mu$ A. The LDO also demonstrates excellent power supply ripple rejection (PSRR) and load and line transient response characteristics. The AAT3220 is a truly high performance LDO regulator especially well suited for circuit applications which are sensitive

to load circuit power consumption and extended battery life.

The LDO regulator output has been specifically optimized to function with low cost, low ESR ceramic capacitors. However, the design will allow for operation with a wide range of capacitor types.

The AAT3220 has complete short circuit and thermal protection. The integral combination of these two internal protection circuits give the AAT3220 a comprehensive safety system to guard against extreme adverse operating conditions. Device power dissipation is limited to the package type and thermal dissipation properties. Refer to the thermal considerations section for details on device operation at maximum output load levels.



## Applications Information

To assure the maximum possible performance is obtained from the AAT3220, please refer to the following application recommendations.

### Input Capacitor

Typically a 1 $\mu$ F or larger capacitor is recommended for  $C_{IN}$  in most applications. A  $C_{IN}$  capacitor is not required for basic LDO regulator operation. However, if the AAT3220 is physically located any distance more than a centimeter or two from the input power source, a  $C_{IN}$  capacitor will be needed for stable operation.  $C_{IN}$  should be located as close to the device  $V_{IN}$  pin as practically possible.  $C_{IN}$  values greater than 1 $\mu$ F will offer superior input line transient response and will assist in maximizing the highest possible power supply ripple rejection.

Ceramic, tantalum or aluminum electrolytic capacitors may be selected for  $C_{IN}$ . There is no specific capacitor ESR requirement for  $C_{IN}$ . For 150mA LDO regulator output operation, ceramic capacitors are recommended for  $C_{IN}$  due to their inherent capability over tantalum capacitors to withstand input current surges from low impedance sources such as batteries in portable devices.

### Output Capacitor

For proper load voltage regulation and operational stability, a capacitor is required between pins  $V_{OUT}$  and GND. The  $C_{OUT}$  capacitor connection to the LDO regulator ground pin should be made as direct as practically possible for maximum device performance. The AAT3220 has been specifically designed to function with very low ESR ceramic capacitors. Although the device is intended to operate with low ESR capacitors, it is stable over a very wide range of capacitor ESR, thus it will also work with some higher ESR tantalum or aluminum electrolytic capacitors. However, for best performance, ceramic capacitors are recommended.

The value of  $C_{OUT}$  typically ranges from 0.47 $\mu$ F to 10 $\mu$ F, however 1 $\mu$ F is sufficient for most operating conditions.

If large output current steps are required by an application, then an increased value for  $C_{OUT}$  should be considered. The amount of capacitance needed can be calculated from the step size of the change in the output load current expected and the voltage excursion that the load can tolerate.

The total output capacitance required can be calculated using the following formula:

$$C_{OUT} = \frac{\Delta I}{\Delta V} \times 15\mu F$$

Where:

$\Delta I$  = maximum step in output current

$\Delta V$  = maximum excursion in voltage that the load can tolerate

Note that use of this equation results in capacitor values approximately two to four times the typical value needed for an AAT3220 at room temperature. The increased capacitor value is recommended if tight output tolerances must be maintained over extreme operating conditions and maximum operational temperature excursions. If tantalum or aluminum electrolytic capacitors are used, the capacitor value should be increased to compensate for the substantial ESR inherent to these capacitor types.

### Capacitor Characteristics

Ceramic composition capacitors are highly recommended over all other types of capacitors for use with the AAT3220. Ceramic capacitors offer many advantages over their tantalum and aluminum electrolytic counterparts. A ceramic capacitor typically has very low ESR, is lower cost, has a smaller PCB footprint and is non-polarized. Line and load transient response of the LDO regulator is improved by using low ESR ceramic capacitors. Since ceramic capacitors are non-polarized, they are less prone to damage if connected incorrectly.

**Equivalent Series Resistance (ESR):** ESR is a very important characteristic to consider when selecting a capacitor. ESR is the internal series resistance associated with a capacitor, which includes lead resistance, internal connections, capacitor size and area, material composition and ambient temperature. Typically capacitor ESR is measured in milliohms for ceramic capacitors and can range to more than several ohms for tantalum or aluminum electrolytic capacitors.

**Ceramic Capacitor Materials:** Ceramic capacitors less than 0.1 $\mu$ F are typically made from NPO or COG materials. NPO and COG materials are typically tight tolerance and very stable over temperature. Larger capacitor values are typically composed of X7R, X5R, Z5U or Y5V dielectric materials. Large

ceramic capacitors, typically greater than 2.2μF are often available in the low cost Y5V and Z5U dielectrics. These two material types are not recommended for use with LDO regulators since the capacitor tolerance can vary by more than ±50% over the operating temperature range of the device. A 2.2μF Y5V capacitor could be reduced to 1μF over the full operating temperature range. This can cause problems for circuit operation and stability. X7R and X5R dielectrics are much more desirable. The temperature tolerance of X7R dielectric is better than ±15%.

Capacitor area is another contributor to ESR. Capacitors, which are physically large in size will have a lower ESR when compared to a smaller sized capacitor of equivalent material and capacitance value. These larger devices can also improve circuit transient response when compared to an equal value capacitor in a smaller package size.

Consult capacitor vendor data sheets carefully when selecting capacitors for use with LDO regulators.

### Short Circuit Protection and Thermal Protection

The AAT3220 is protected by both current limit and over temperature protection circuitry. The internal short circuit current limit is designed to activate when the output load demand exceeds the maximum rated output. If a short circuit condition were to continually draw more than the current limit threshold, the LDO regulator's output voltage will drop to a level necessary to supply the current demanded by the load. Under short circuit or other over current operating conditions, the output voltage will drop and the AAT3220's die temperature will increase rapidly. Once the regulator's power dissipation capacity has been exceeded and the internal die temperature reaches approximately 140°C the system thermal protection circuit will become active. The internal thermal protection circuit will actively turn off the LDO regulator output pass device to prevent the possibility of over temperature damage. The LDO regulator output will remain in a shutdown state until the internal die temperature falls back below the 140°C trip point.

The combination and interaction between the short circuit and thermal protection systems allow the LDO regulator to withstand indefinite short circuit conditions without sustaining permanent damage.

### No-Load Stability

The AAT3220 is designed to maintain output voltage regulation and stability under operational no-load conditions. This is an important characteristic for applications where the output current may drop to zero. An output capacitor is required for stability under no load operating conditions. Refer to the output capacitor considerations section for recommended typical output capacitor values.

### Thermal Considerations and High Output Current Applications

The AAT3220 is designed to deliver a continuous output load current of 150mA under normal operating conditions. The limiting characteristic for the maximum output load safe operating area is essentially package power dissipation and the internal pre-set thermal limit of the device. In order to obtain high operating currents, careful device layout and circuit operating conditions need to be taken into account. The following discussions will assume the LDO regulator is mounted on a printed circuit board utilizing the minimum recommended footprint and the printed circuit board is 0.062 inch thick FR4 material with one ounce copper.

At any given ambient temperature ( $T_A$ ) the maximum package power dissipation can be determined by the following equation:

$$P_{D(MAX)} = [T_{J(MAX)} - T_A] / \Theta_{JA}$$

Constants for the AAT3220 are  $T_{J(MAX)}$ , the maximum junction temperature for the device which is 125°C and  $\Theta_{JA} = 200^\circ\text{C/W}$ , the package thermal resistance. Typically, maximum conditions are calculated at the maximum operating temperature where  $T_A = 85^\circ\text{C}$ , under normal ambient conditions  $T_A = 25^\circ\text{C}$ . Given  $T_A = 85^\circ\text{C}$ , the maximum package power dissipation is 200mW. At  $T_A = 25^\circ\text{C}$ , the maximum package power dissipation is 500mW.

The maximum continuous output current for the AAT3220 is a function of the package power dissipation and the input to output voltage drop across the LDO regulator. Refer to the following simple equation:

$$I_{OUT(MAX)} < P_{D(MAX)} / (V_{IN} - V_{OUT})$$

For example, if  $V_{IN} = 5V$ ,  $V_{OUT} = 3V$  and  $T_A = 25^\circ$ ,  $I_{OUT(MAX)} < 250mA$ . The output short circuit protection threshold is set between 150mA and 300mA. If the output load current were to exceed 250mA or if the ambient temperature were to increase, the internal die temperature will increase. If the condition remained constant and the short circuit protection were not to activate, there would be a potential damage hazard to LDO regulator since the thermal protection circuit will only activate after a short circuit event occurs on the LDO regulator output.

To figure what the maximum input voltage would be for a given load current refer to the following equation. This calculation accounts for the total power dissipation of the LDO Regulator, including that cause by ground current.

$$P_{D(MAX)} = (V_{IN} - V_{OUT})I_{OUT} + (V_{IN} \times I_{GND})$$

This formula can be solved for  $V_{IN}$  to determine the maximum input voltage.

$$V_{IN(MAX)} = (P_{D(MAX)} + (V_{OUT} \times I_{OUT})) / (I_{OUT} + I_{GND})$$

The following is an example for an AAT3220 set for a 3.0 volt output:

From the discussion above,  $P_{D(MAX)}$  was determined to equal 417mW at  $T_A = 25^\circ C$ .

$$\begin{aligned} V_{OUT} &= 3.0 \text{ volts} \\ I_{OUT} &= 150mA \\ I_{GND} &= 1.1\mu A \end{aligned}$$

$$V_{IN(MAX)} = (500mW + (3.0V \times 150mA)) / (150mA + 1.1\mu A)$$

$$V_{IN(MAX)} > 5.5V$$

Thus, the AAT3220 can sustain a constant 3.0V output at a 150mA load current as long as  $V_{IN}$  is  $\leq 5.5V$  at an ambient temperature of  $25^\circ C$ . 5.5V is the maximum input operating voltage for the AAT3220, thus at  $25^\circ C$ , the device would not have any thermal concerns or operational  $V_{IN(MAX)}$  limits.

This situation can be different at  $85^\circ C$ . The following is an example for an AAT3220 set for a 3.0 volt output at  $85^\circ C$ :

From the discussion above,  $P_{D(MAX)}$  was determined to equal 200mW at  $T_A = 85^\circ C$ .

$$\begin{aligned} V_{OUT} &= 3.0 \text{ volts} \\ I_{OUT} &= 150mA \\ I_{GND} &= 1.1\mu A \end{aligned}$$

$$V_{IN(MAX)} = (200mW + (3.0V \times 150mA)) / (150mA + 1.1\mu A)$$

$$V_{IN(MAX)} = 4.33V$$

Higher input to output voltage differentials can be obtained with the AAT3220, while maintaining device functions in the thermal safe operating area. To accomplish this, the device thermal resistance must be reduced by increasing the heat sink area or by operating the LDO regulator in a duty cycled mode.

For example, an application requires  $V_{IN} = 5.0V$  while  $V_{OUT} = 3.0V$  at a 150mA load and  $T_A = 85^\circ C$ .  $V_{IN}$  is greater than 4.33V, which is the maximum safe continuous input level for  $V_{OUT} = 3.0V$  at 150mA for  $T_A = 85^\circ C$ . To maintain this high input voltage and output current level, the LDO regulator must be operated in a duty cycled mode. Refer to the following calculation for duty cycle operation:

$P_{D(MAX)}$  is assumed to be 200mW

$$\begin{aligned} I_{GND} &= 1.1\mu A \\ I_{OUT} &= 150mA \\ V_{IN} &= 5.0 \text{ volts} \\ V_{OUT} &= 3.0 \text{ volts} \end{aligned}$$

$$\%DC = 100(P_{D(MAX)} / ((V_{IN} - V_{OUT})I_{OUT} + (V_{IN} \times I_{GND})))$$

$$\%DC = 100(200mW / ((5.0V - 3.0V)150mA + (5.0V \times 1.1\mu A)))$$

$$\%DC = 66.67\%$$

For a 150mA output current and a 2.0 volt drop across the AAT3220 at an ambient temperature of  $85^\circ C$ , the maximum on time duty cycle for the device would be 66.67%.

The following family of curves shows the safe operating area for duty cycled operation from ambient room temperature to the maximum operating level.

**Device Duty Cycle vs.  $V_{DROP}$**   
 $V_{OUT} = 2.5V @ 25 \text{ degrees C}$

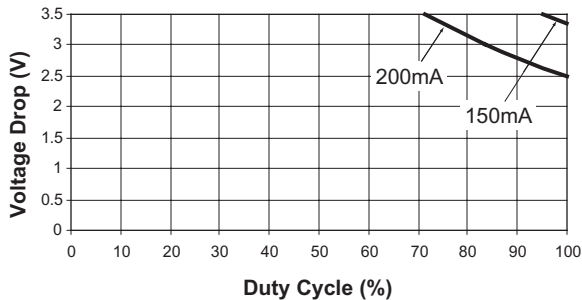

**Device Duty Cycle vs.  $V_{DROP}$**   
 $V_{OUT} = 2.5V @ 50 \text{ degrees C}$

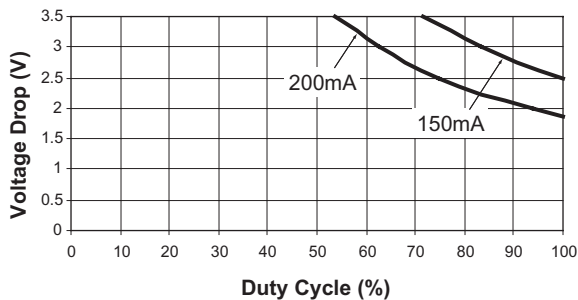

**Device Duty Cycle vs.  $V_{DROP}$**   
 $V_{OUT} = 2.5V @ 85 \text{ degrees C}$

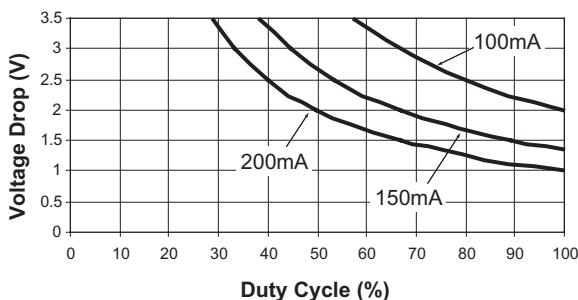

### High Peak Output Current Applications

Some applications require the LDO regulator to operate at continuous nominal levels with short duration high current peaks. The duty cycles for both output current levels must be taken into account. To do so, one would first need to calculate the power dissipation at the nominal continuous level, then factor in the additional power dissipation due to the short duration high current peaks.

For example, a 3.0V system using a AAT3220IGV-2.5-T1 operates at a continuous 100mA load current level and has short 150mA current peaks. The current peak occurs for 378 $\mu$ s out of a 4.61ms period. It will be assumed the input voltage is 5.0V.

First the current duty cycle percentage must be calculated:

$$\% \text{ Peak Duty Cycle} = X/100 = 378\mu\text{s}/4.61\text{ms}$$

$$\% \text{ Peak Duty Cycle} = 8.2\%$$

The LDO Regulator will be under the 100mA load for 91.8% of the 4.61ms period and have 150mA peaks occurring for 8.2% of the time. Next, the continuous nominal power dissipation for the 100mA load should be determined then multiplied by the duty cycle to conclude the actual power dissipation over time.

$$P_{D(\text{MAX})} = (V_{IN} - V_{OUT})I_{OUT} + (V_{IN} \times I_{GND})$$

$$P_{D(100\text{mA})} = (4.2\text{V} - 3.0\text{V})100\text{mA} + (4.2\text{V} \times 1.1\mu\text{A})$$

$$P_{D(100\text{mA})} = 120\text{mW}$$

$$P_{D(91.8\% \text{D/C})} = \% \text{DC} \times P_{D(100\text{mA})}$$

$$P_{D(91.8\% \text{D/C})} = 0.918 \times 120\text{mW}$$

$$P_{D(91.8\% \text{D/C})} = 110.2\text{mW}$$

The power dissipation for 100mA load occurring for 91.8% of the duty cycle will be 110.2mW. Now the power dissipation for the remaining 8.2% of the duty cycle at the 150mA load can be calculated:

$$P_{D(\text{MAX})} = (V_{IN} - V_{OUT})I_{OUT} + (V_{IN} \times I_{GND})$$

$$P_{D(150\text{mA})} = (4.2\text{V} - 3.0\text{V})150\text{mA} + (4.2\text{V} \times 1.1\mu\text{A})$$

$$P_{D(150\text{mA})} = 180\text{mW}$$

$$P_{D(8.2\% \text{D/C})} = \% \text{DC} \times P_{D(150\text{mA})}$$

$$P_{D(8.2\% \text{D/C})} = 0.082 \times 180\text{mW}$$

$$P_{D(8.2\% \text{D/C})} = 14.8\text{mW}$$

The power dissipation for a 150mA load occurring for 8.2% of the duty cycle will be 14.8mW. Finally, the two power dissipation levels can be summed to determine the total power dissipation under the varied load.

$$P_{D(\text{total})} = P_{D(100\text{mA})} + P_{D(150\text{mA})}$$
$$P_{D(\text{total})} = 110.2\text{mW} + 14.8\text{mW}$$
$$P_{D(\text{total})} = 125.0\text{mW}$$

The maximum power dissipation for the AAT3220 operating at an ambient temperature of 85°C is 200mW. The device in this example will have a total power dissipation of 125.0mW. This is well within the thermal limits for safe operation of the device.

### **Printed Circuit Board Layout Recommendations**

In order to obtain the maximum performance from the AAT3220 LDO regulator, very careful attention

must be paid in regard to the printed circuit board layout. If grounding connections are not properly made, power supply ripple rejection and LDO regulator transient response can be compromised.

The LDO Regulator external capacitors  $C_{IN}$  and  $C_{OUT}$  should be connected as directly as possible to the ground pin of the LDO Regulator. For maximum performance with the AAT3220, the ground pin connection should then be made directly back to the ground or common of the source power supply. If a direct ground return path is not possible due to printed circuit board layout limitations, the LDO ground pin should then be connected to the common ground plane in the application layout.

### Ordering Information

Output Voltage	Package	Marking	Part Number	
			Bulk	Tape and Reel
1.8V	SOT-23-3		N/A	AAT3220IGY-1.8-T1
2.0V	SOT-23-3		N/A	AAT3220IGY-2.0-T1
2.3V	SOT-23-3		N/A	AAT3220IGY-2.3-T1
2.4V	SOT-23-3		N/A	AAT3220IGY-2.4-T1
2.5V	SOT-23-3		N/A	AAT3220IGY-2.5-T1
2.7V	SOT-23-3		N/A	AAT3220IGY-2.7-T1
2.8V	SOT-23-3		N/A	AAT3220IGY-2.8-T1
2.85V	SOT-23-3		N/A	AAT3220IGY-2.85-T1
3.0V	SOT-23-3		N/A	AAT3220IGY-3.0-T1
3.3V	SOT-23-3		N/A	AAT3220IGY-3.3-T1
3.5V	SOT-23-3		N/A	AAT3220IGY-3.5-T1
1.8V	SOT-89		N/A	AAT3220IQY-1.8-T1
2.0V	SOT-89		N/A	AAT3220IQY-2.0-T1
2.3V	SOT-89		N/A	AAT3220IQY-2.3-T1
2.4V	SOT-89		N/A	AAT3220IQY-2.4-T1
2.5V	SOT-89		N/A	AAT3220IQY-2.5-T1
2.7V	SOT-89		N/A	AAT3220IQY-2.7-T1
2.8V	SOT-89		N/A	AAT3220IQY-2.8-T1
2.85V	SOT-89		N/A	AAT3220IQY-2.85-T1
3.0V	SOT-89		N/A	AAT3220IQY-3.0-T1
3.3V	SOT-89		N/A	AAT3220IQY-3.3-T1
3.5V	SOT-89		N/A	AAT3220IQY-3.5-T1



### Package Information

#### SOT-23-3

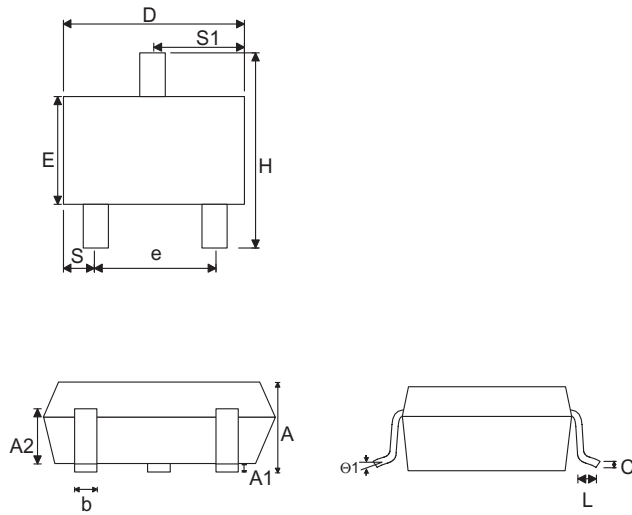

Dim	Millimeters		Inches	
	Min	Max	Min	Max
A	1.00	1.70	0.040	0.067
A1	0.00	0.10	0.000	0.003
A2	0.70	3.15	0.027	0.124
b	0.35	0.85	0.013	0.033
C	0.10	0.35	0.003	0.013
D	2.70	3.10	0.106	0.122
E	1.40	1.80	0.055	0.070
e	0.00	0.00	0.000	0.000
H	2.60	3.00	0.094	0.118
L	0.37	0.00	0.014	0.000
S	0.45	0.55	0.017	0.021
S1	0.85	1.05	0.033	0.041
θ1	1°	9°	1°	9°

Note:

1. PACKAGE BODY SIZE EXCLUDE MOLD FLASH PROTRUSIONS OR GATE BURRS.
2. TOLERANCE  $\pm 0.1000$  mm (4mi) UNLESS OTHERWISE SPECIFIED
3. COPLANARITY: 0.1000
4. DIMENSION L IS MEASURED IN GAGE PLANE

#### SOT-89

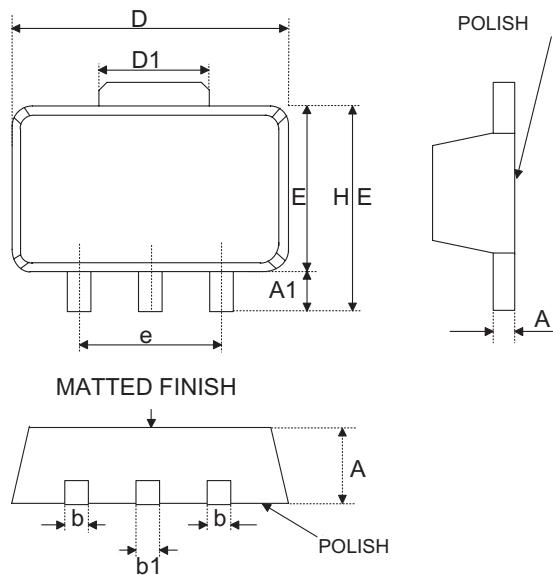

Dim	Millimeters		Inches	
	Min	Max	Min	Max
A	1.40	1.60	0.055	0.063
A1	0.80	0.00	0.031	0.000
b	0.36	0.48	0.014	0.018
b1	0.41	0.53	0.016	0.020
C	0.38	0.43	0.014	0.017
D	4.40	4.60	0.173	0.181
D1	1.40	1.75	0.055	0.069
HE	0.00	4.25	0.000	0.167
E	2.40	2.60	0.094	0.102
e	2.90	3.10	0.114	0.122

This page intentionally left blank.