

AC05DGM to AC05FGM

5 A MOLD TRIAC

PACKAGE DIMENSIONS (Unit: mm)

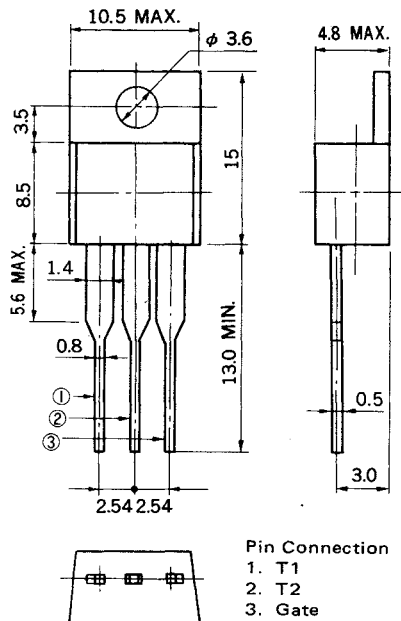

The AC05DGM to AC05FGM are all diffused mold type triac granted RMS On-state current 5 Amps, with rated voltages up to 600 volts.

FEATURES

- 50 A Surge current
- TO-220AB mold package
- Low cost

APPLICATIONS

- Motor speed control
- Lamp dimmer, Temperature controllers
- Various solid state switches, etc.

MAXIMUM RATINGS

CHARACTERISTIC	SYMBOL	AC05DGM	AC05EGM	AC05FGM	UNIT	NOTE
Repetitive Peak off Voltage	V_{DRM}	400	500	600	V	
Non-repetitive Peak off Voltage	V_{DSM}	500	600	700	V	
RMS On-State Current	$I_T (RMS)$	5 ($T_c = 107^\circ C$)			A	See Fig. 11, 12
Peak Surge On-State Current	I_{TSM}	50 (50 Hz, Non-repetitive)			A	See Fig. 2
Fusing Current	$\int i^2 dt$	10 ($1 ms \leq t \leq 10 ms$)			$A^2 s$	
Peak Gate Power Dissipation	P_{GM}	3 ($f \geq 50 Hz, Duty \leq 10\%$)			W	
Average Gate Power Dissipation	$P_G (AV)$	0.3			W	
Peak Gate Current	I_{FGM}	± 3 ($f \geq 50 Hz, Duty \leq 10\%$)			A	
Junction Temperature	T_j	-40 to +125			$^\circ C$	
Storage Temperature	T_{stg}	-40 to +125			$^\circ C$	

ELECTRICAL CHARACTERISTICS ($T_j = 25^\circ\text{C}$)

CHARACTERISRIC	SYMBOL	TEST CONDITIONS	MIN.	TYP.	MAX.	UNIT	NOTE
Peak off-State Current	I_{DRM}	$T_j = 125^\circ\text{C}$ $V_{DM} = V_{DRM}$	—	—	1	mA	
On-State Voltage	V_{TM}	$I_{TM} = 5\text{ A}$	—	—	1.8	V	See Fig. 1
Gate Trigger Current	Trigger Mode I II III IV	I_{GT} $V_{DM} = 12\text{ V}$ $R_L = 30\ \Omega$	—	—	10	mA	See Fig. 4
			—	—	—		
			—	—	10		
			—	—	10		
Gate Trigger Voltage	Trigger Mode I II III IV	V_{GT} $V_{DM} = 12\text{ V}$ $R_L = 30\ \Omega$	—	—	1.5	V	See Fig. 4
			—	—	2.0		
			—	—	1.5		
			—	—	1.5		
Gate Non-Trigger Voltage	V_{GD}	$T_j = 125^\circ\text{C}$, $V_{DM} = \frac{1}{2}V_{DRM}$	0.2	—	—	V	
Commutating dv/dt	$(dv/dt)\text{ C}$	$T_j = 125^\circ\text{C}$ $(di_T/dt)\text{ C} = -2.7\text{ A/ms}$ $V_D = 400\text{ V}$	5	—	—	V/ μs	
Holding Current	I_H	$V_D = 24\text{ V}$, $I_{TM} = 5\text{ A}$	—	10	—	mA	
Thermal Resistance	$R_{th(j-c)}$	Junction to Case	—	—	3.0	$^\circ\text{C/W}$	See Fig. 13

Trigger Mode & Test Circuit

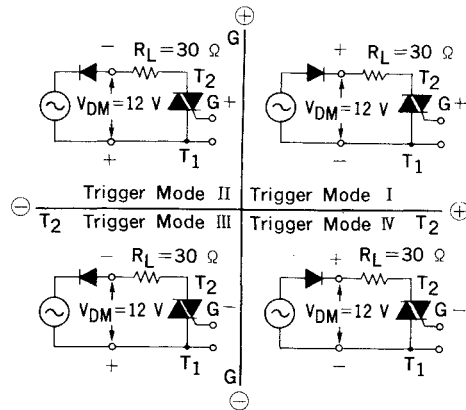

Fig. 1 $i_T - v_T$ CHARACTERISTIC

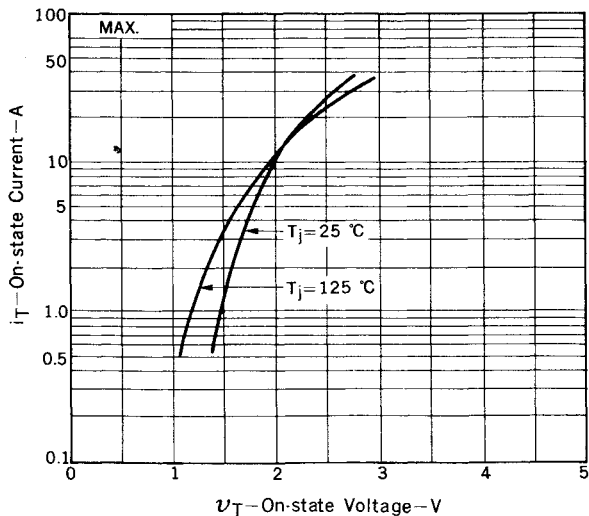

Fig. 2 I_{TSM} RATING

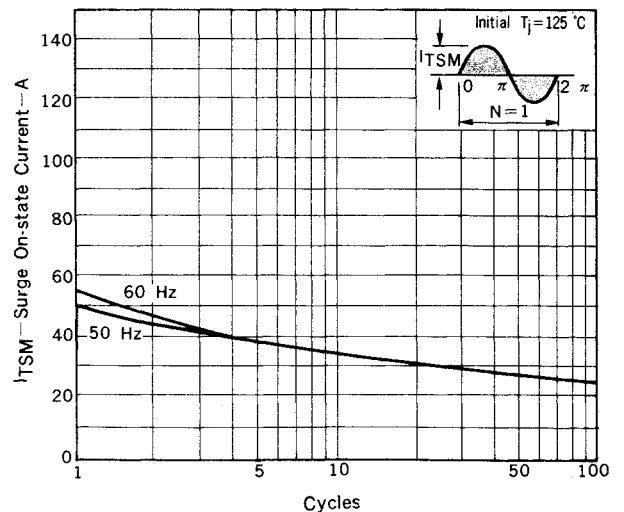

Fig. 3 $V_G - I_G$ RATING

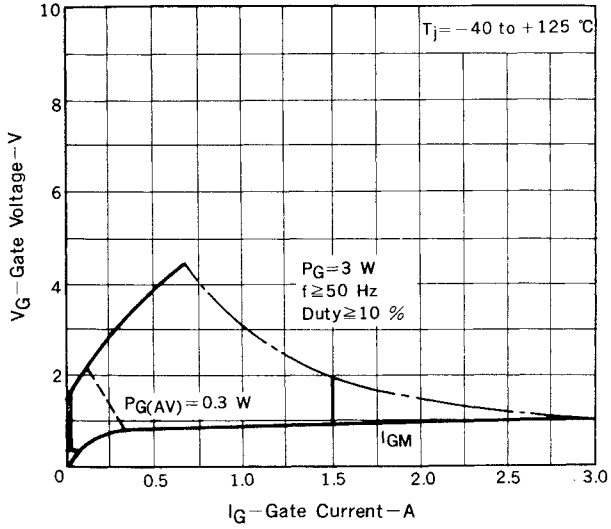

Fig. 4 $V_{GT} - I_{GT}$ CHARACTERISTIC

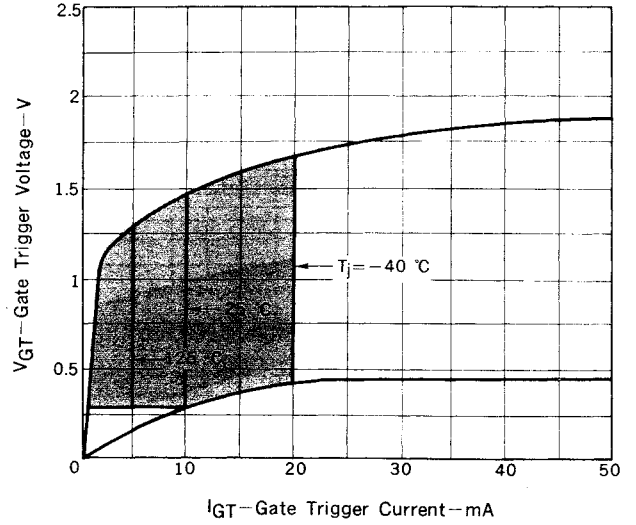

Fig. 5 $I_{GT} - T_a$ TYPICAL DISTRIBUTION

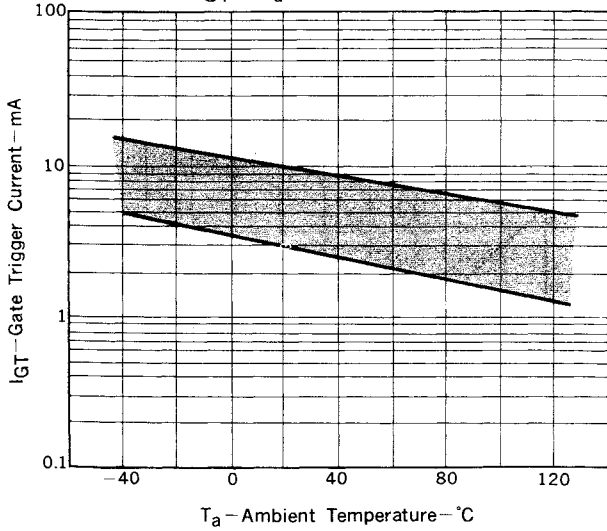

Fig. 6 $V_{GT} - T_a$ TYPICAL DISTRIBUTION

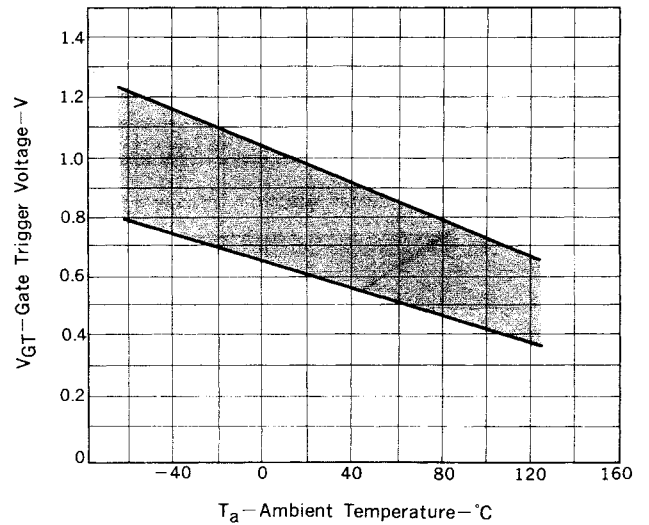

Fig. 7 $i_{GT} - \tau$ TYPICAL DISTRIBUTION

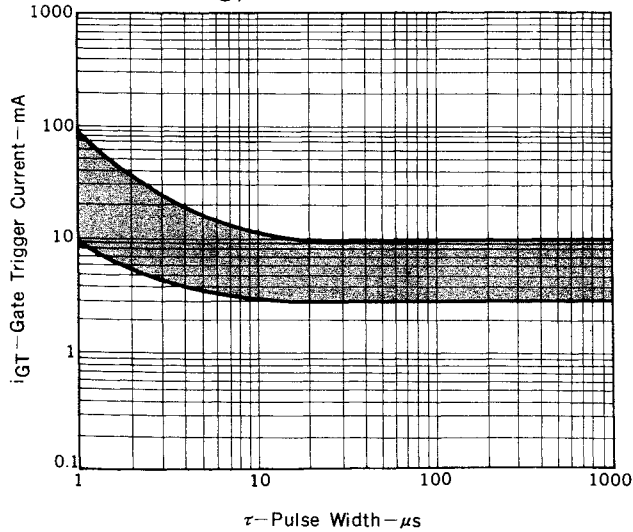

Fig. 8 $v_{GT} - \tau$ TYPICAL DISTRIBUTION

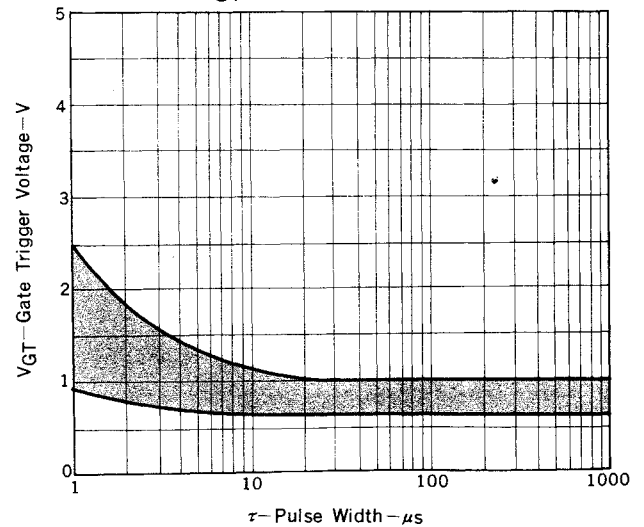

Fig. 9 $I_H - T_a$ TYPICAL DISTRIBUTION

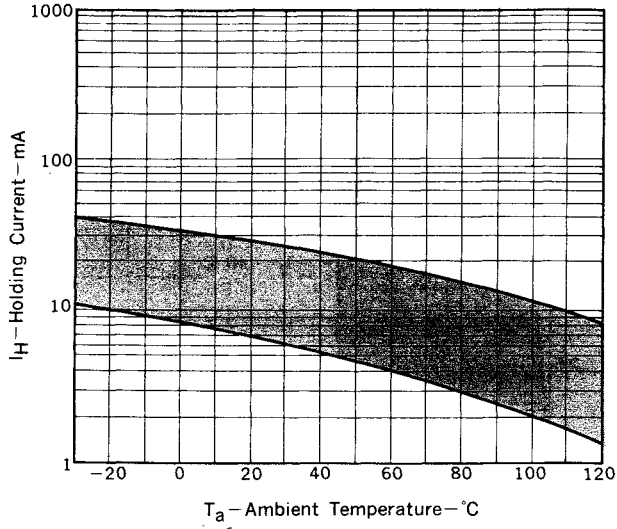

Fig. 10 $P_{T(AV)} - I_T(RMS)$ CHARACTERISTIC

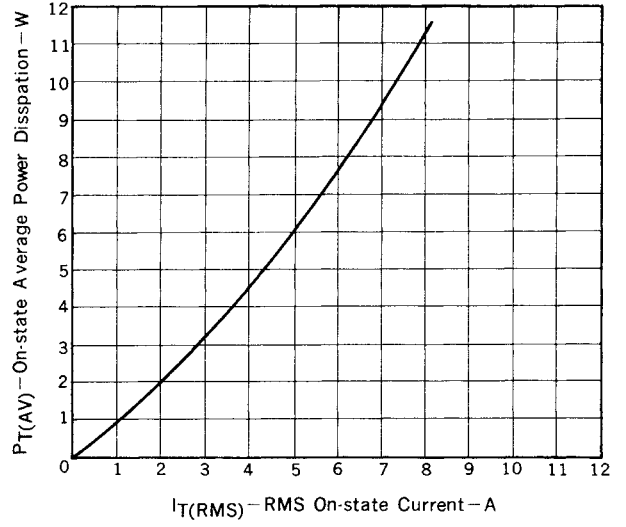

Fig. 11 $T_c - I_T(RMS)$ RATING

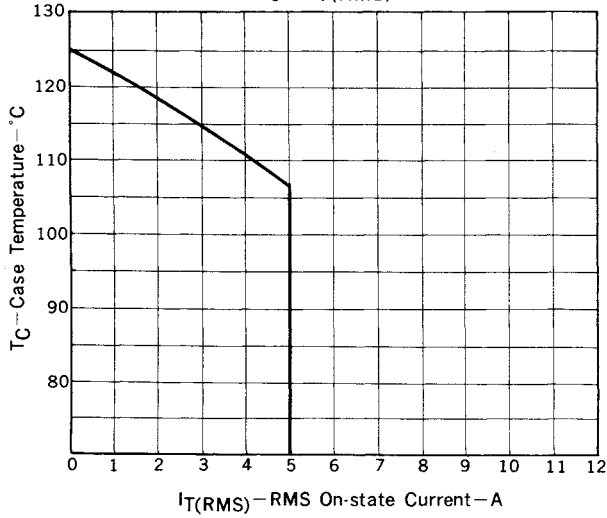

Fig. 12 $T_a - I_T(RMS)$ RATING

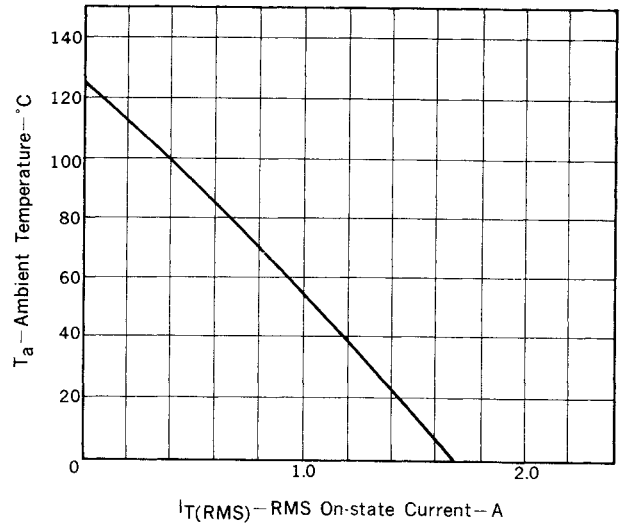
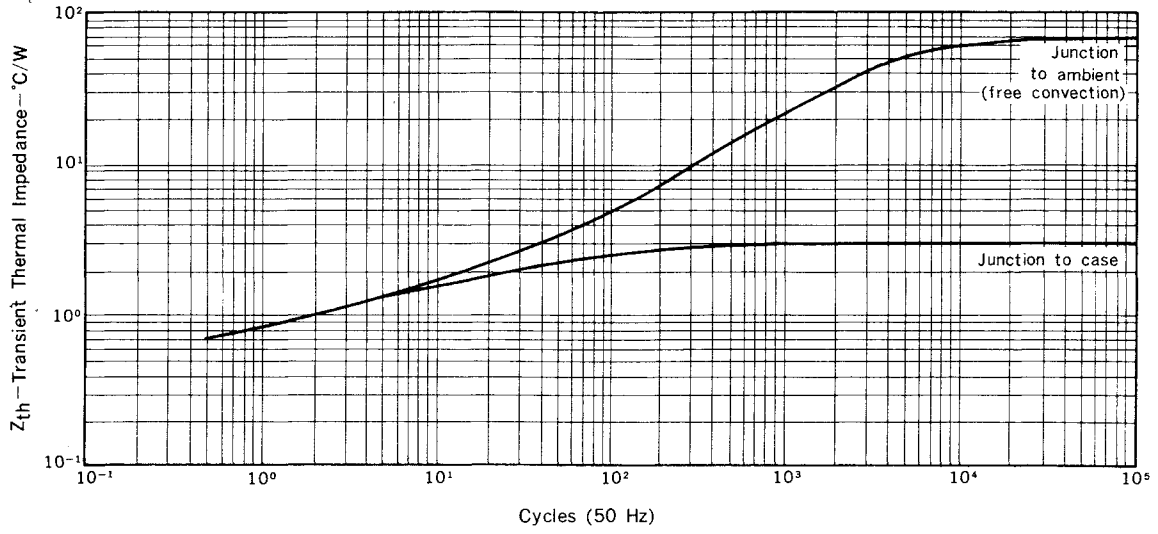

Fig. 13 Z_{th} CHARACTERISTIC



NEC Corporation

INTERNATIONAL ELECTRON DEVICES DIV.
SUMITOMO MITA Building, 37-8,
Shiba Gochome, Minato-ku, Tokyo 108, Japan
Tel: Tokyo 456-3111
Telex Address: NECTOK J22686
Cable Address: NEC TOKYO

SC-1032
APR.-25-85M
Printed in Japan