

# AC16DGM to AC16FGM

## 16 A MOLD TRIAC

### PACKAGE DIMENSIONS in millimeters

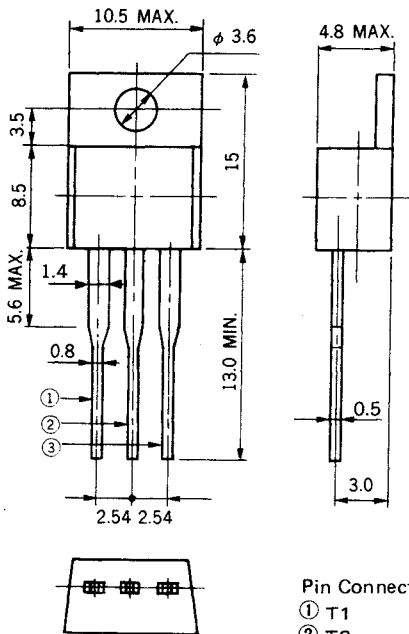

Pin Connection  
 ① T1  
 ② T2  
 ③ Gate

The AC16DGM to AC16FGM are all diffused mold type TRIAC granted RMS On-state current 16 Amps, with rated voltages up to 600 Volts.

### FEATURES

- 150 A Surge Current
- TO-220AB mold package
- Low cost

### APPLICATIONS

Motor speed control,  
 Lamp dimmer, Temperature controllers,  
 Various solid state switches, etc.

### MAXIMUM RATINGS

ITEM	SYMBOL	AC16DGM	AC16EGM	AC16FGM	UNIT	NOTE
Repetitive Peak-off Voltage	$V_{DRM}$	400	500	600	V	
Non-Repetitive Peak-off Voltage	$V_{DSM}$	500	600	700	V	
RMS On-state Current	$I_T(RMS)$	16 ( $T_c = 100^\circ C$ )			A	See Fig. 11, 12
Surge On-state Current	$I_{TSM}$	150 (50 Hz Non-repetitive)			A	See Fig. 2
Fusing Current	$\int i_T^2 dt$	100			A <sup>2</sup> S	
Peak Gate Power Dissipation	$P_{GM}$	5			W	
Average Gate Power Dissipation	$P_{G(AV)}$	0.5			W	
Peak Gate Current	$I_{GM}$	±3			A	
Junction Temperature	$T_j$	-40 to +125			°C	
Storage Temperature	$T_{stg}$	-40 to +125			°C	

ELECTRICAL CHARACTERISTICS (T<sub>j</sub> = 25 °C)

ITEM	SYMBOL	TEST CONDITIONS	MIN.	TYP.	MAX.	UNIT	NOTE	
Peak Off-State Current	I <sub>DRM</sub>	V <sub>DM</sub> = V <sub>DRM</sub>	T <sub>j</sub> = 25 °C	—	—	0.1	mA	—
			T = 125 °C	—	—	2		
On-State Voltage	V <sub>TM</sub>	I <sub>TM</sub> = 25 A	—	—	1.4	V	See Fig. 1	
Critical Rate of Rise of Off-state Voltage	dv/dt	T <sub>j</sub> = 125 °C V <sub>DM</sub> = $\frac{2}{3}$ V <sub>DRM</sub>	—	100	—	V/μs	—	
DC Gate Trigger Current	I <sub>GT</sub>	V <sub>DM</sub> = 12 V R <sub>L</sub> = 30 Ω	T <sub>2</sub> +, G+	—	—	30	mA	See Fig. 3, 4, 5, 7
			T <sub>2</sub> -, G+	—	—	80		
			T <sub>2</sub> -, G-	—	—	30		
			T <sub>2</sub> +, G-	—	—	30		
DC Gate Trigger Voltage	V <sub>GT</sub>	V <sub>DM</sub> = 12 V R <sub>L</sub> = 30 Ω	T <sub>2</sub> +, G+	—	—	1.5	V	See Fig. 3, 4, 6, 8
			T <sub>2</sub> -, G+	—	—	2.0		
			T <sub>2</sub> -, G-	—	—	1.5		
			T <sub>2</sub> +, G-	—	—	1.5		
Gate Non-Trigger Voltage	V <sub>GD</sub>	T <sub>j</sub> = 125 °C V <sub>DM</sub> = $\frac{1}{2}$ V <sub>DRM</sub>	0.3	—	—	V	—	
DC Holding Current	I <sub>H</sub>	V <sub>D</sub> = 24 V	—	30	—	mA	—	
Critical Rate of Rise of Commutating Off-State Voltage	(dv/dt) <sub>c</sub>	T <sub>j</sub> = 125 °C, I <sub>TM</sub> = 22 A (di <sub>T</sub> /dt) <sub>c</sub> = -8 A/ms V <sub>D</sub> = 400 V	10	—	—	V/μs	—	
Thermal Resistance	R <sub>th(j-c)</sub>	Junction-to-Case	—	—	1.5	°C/W	See Fig. 13	

Trigger Mode & Test Circuit

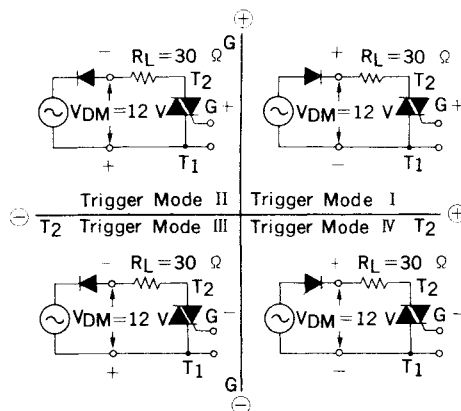

Fig. 1  $i_T - v_T$  CHARACTERISTIC

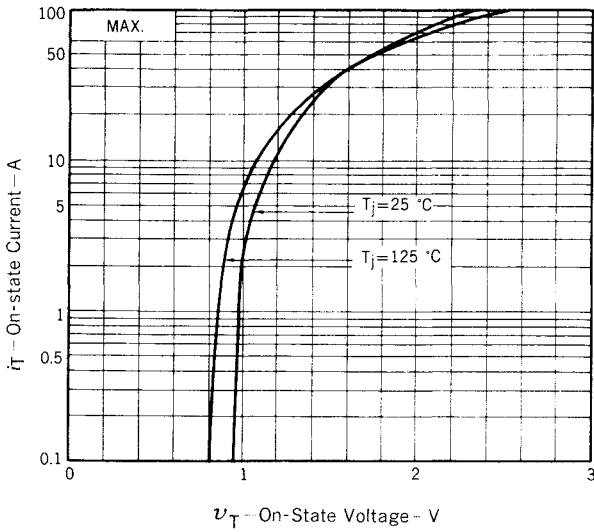

Fig. 2  $I_{TSM}$  RATING

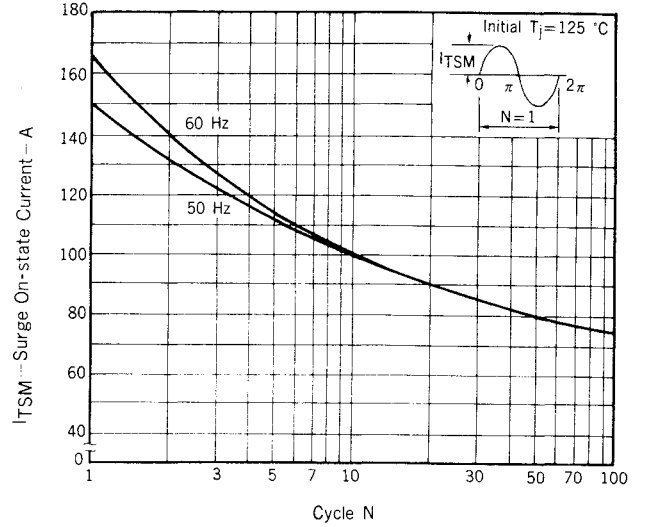

Fig. 3  $V_G - I_G$  RATING

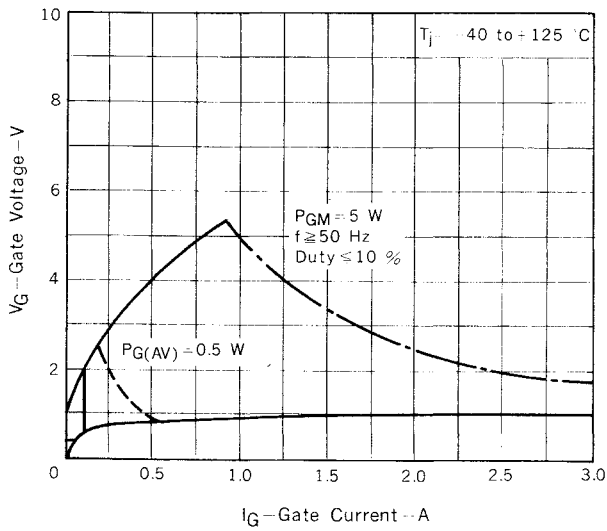

Fig. 4  $V_{GT} - I_{GT}$  CHARACTERISTIC

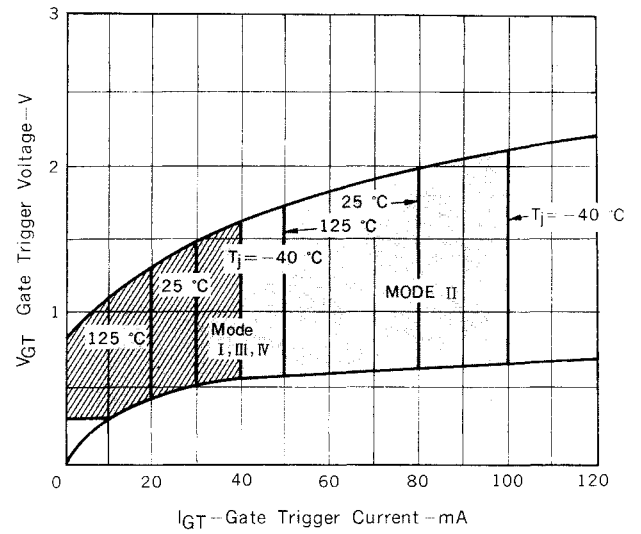

Fig. 5  $I_{GT} - T_a$  TYPICAL DISTRIBUTION

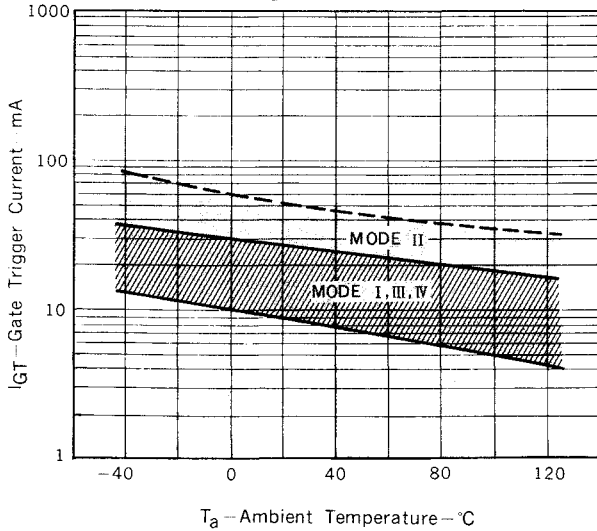

Fig. 6  $V_{GT} - T_a$  TYPICAL DISTRIBUTION

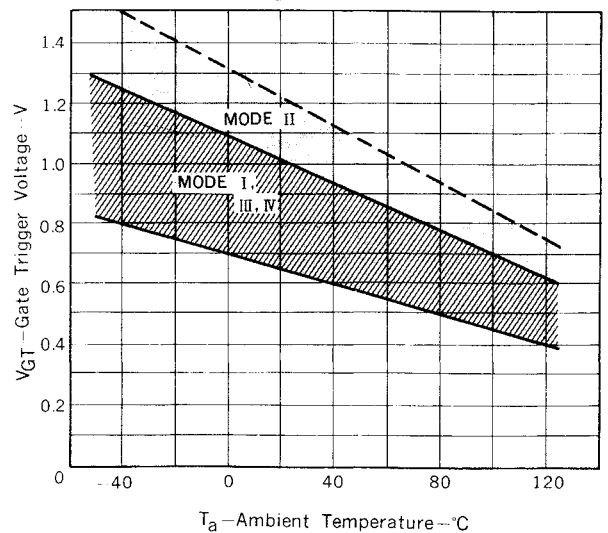

Fig. 7  $i_{GT} - \tau$  TYPICAL DISTRIBUTION

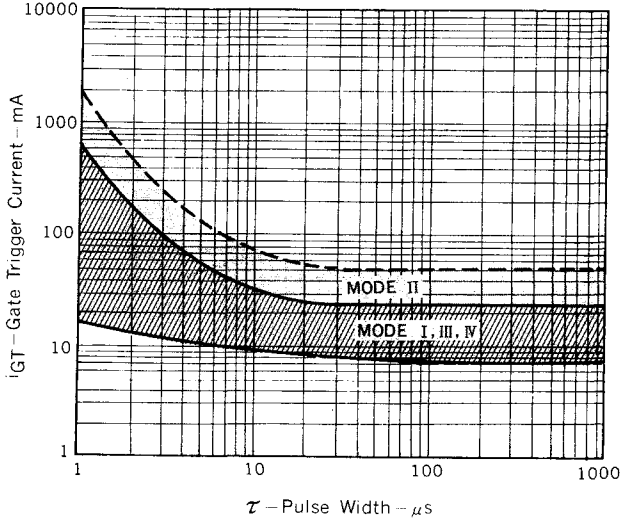

Fig. 8  $v_{GT} - \tau$  TYPICAL DISTRIBUTION

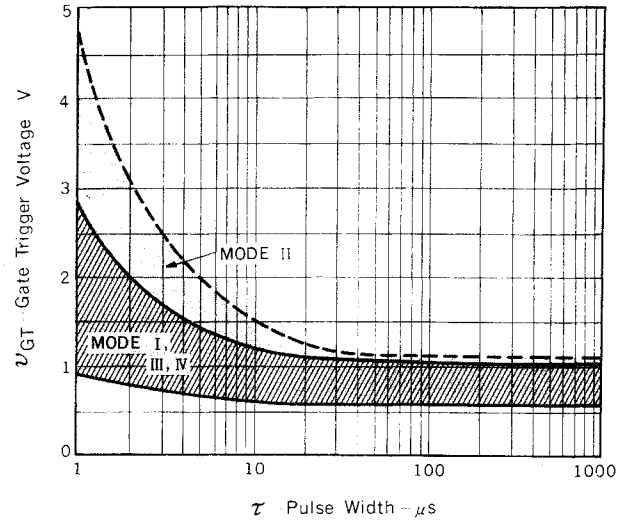

Fig. 9  $I_H - T_a$  CHARACTERISTIC

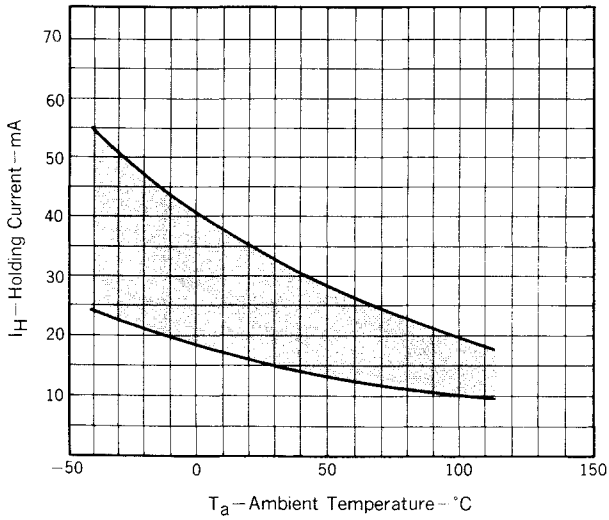

Fig. 10  $P_{T(AV)} - I_{T(RMS)}$  CHARACTERISTIC

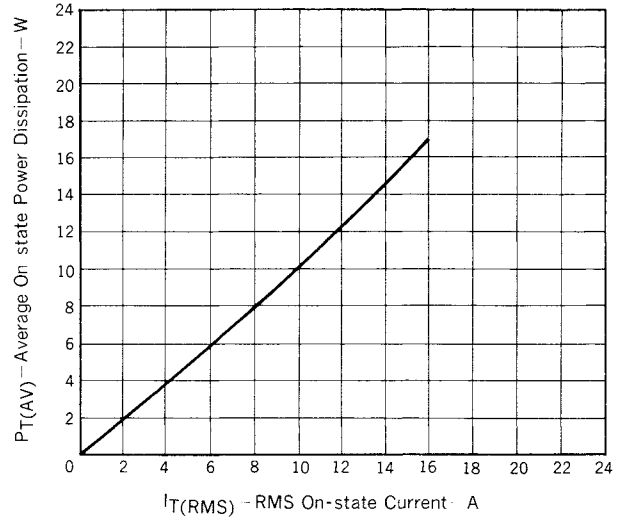

Fig. 11  $T_c - I_{T(RMS)}$  RATING

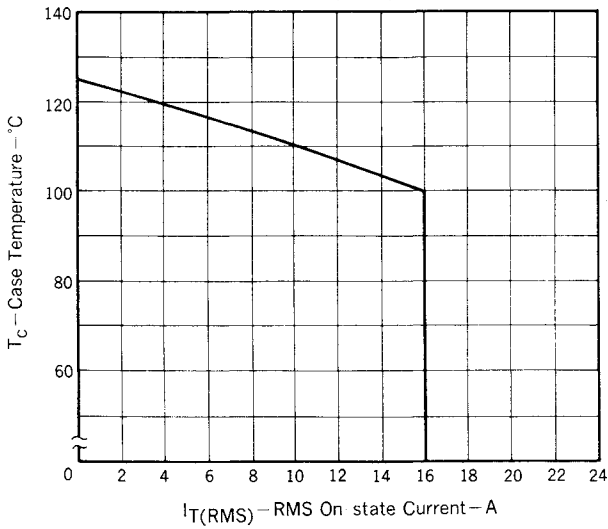

Fig. 12  $T_a - I_{T(RMS)}$  RATING

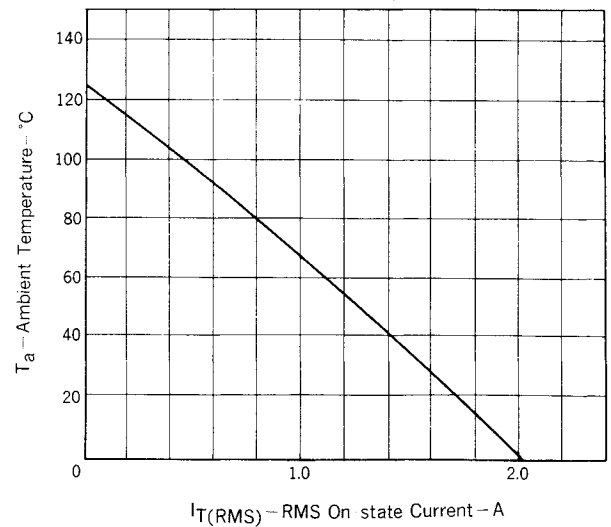
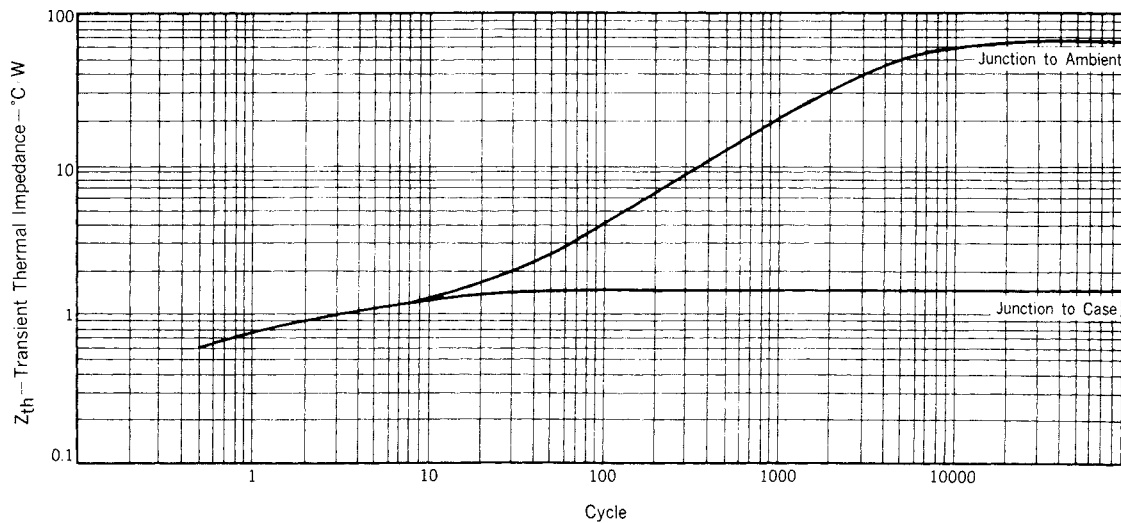

Fig. 13  $Z_{th}$  CHARACTERISTIC



---

## NEC Corporation

INTERNATIONAL ELECTRON DEVICES DIV.  
SUMITOMO MITA Building, 37-8,  
Shiba Gochome, Minato-ku, Tokyo 108, Japan  
Tel: Tokyo 456-3111  
Telex Address: NECTOK J22686  
Cable Address: NEC TOKYO

SC-1036  
OCT.-1-85M  
Printed in Japan