



Increment/Decrement Digital Potentiometer

AD5220

FEATURES

- 128 Position
- Potentiometer Replacement
- 10 kΩ, 50 kΩ, 100 kΩ
- Very Low Power: 40 μA Max
- Increment/Decrement Count Control

APPLICATIONS

- Mechanical Potentiometer Replacement
- Remote Incremental Adjustment Applications
- Instrumentation: Gain, Offset Adjustment
- Programmable Voltage-to-Current Conversion
- Programmable Filters, Delays, Time Constants
- Line Impedance Matching
- Power Supply Adjustment

GENERAL DESCRIPTION

The AD5220 provides a single channel, 128-position digitally controlled variable resistor (VR) device. This device performs the same electronic adjustment function as a potentiometer or variable resistor. These products were optimized for instrument and test equipment push-button applications. A choice between bandwidth or power dissipation are available as a result of the wide selection of end-to-end terminal resistance values.

The AD5220 contains a fixed resistor with a wiper contact that taps the fixed resistor value at a point determined by a digitally controlled UP/DOWN counter. The resistance between the wiper and either end point of the fixed resistor provides a constant resistance step size that is equal to the end-to-end resistance divided by the number of positions (e.g., $R_{STEP} = 10\text{ k}\Omega / 128 = 78\ \Omega$). The variable resistor offers a true adjustable value of resistance, between the A terminal and the wiper, or the B terminal and the wiper. The fixed A-to-B terminal resistance of 10 kΩ, 50 kΩ, or 100 kΩ has a nominal temperature coefficient of 800 ppm/°C.

The chip select \overline{CS} , count CLK and $\overline{U/D}$ direction control inputs set the variable resistor position. These inputs that control the internal UP/DOWN counter can be easily generated with mechanical or push button switches (or other contact closure devices). External debounce circuitry is required for the negative-edge sensitive CLK pin. This simple digital interface eliminates the need for microcontrollers in front panel interface designs.

The AD5220 is available in both surface mount (SO-8) and the 8-lead plastic DIP package. For ultracompact solutions selected models are available in the thin μSOIC package. All parts are guaranteed to operate over the extended industrial temperature range of -40°C to +85°C. For 3-wire, SPI compatible interface applications, see the AD7376/AD8400/AD8402/AD8403 products.

FUNCTIONAL BLOCK DIAGRAM

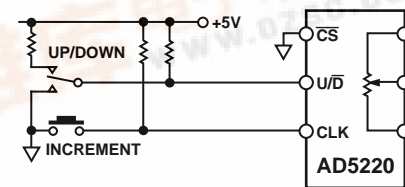
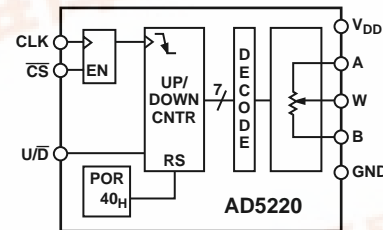

Figure 1. Typical Push-Button Control Application

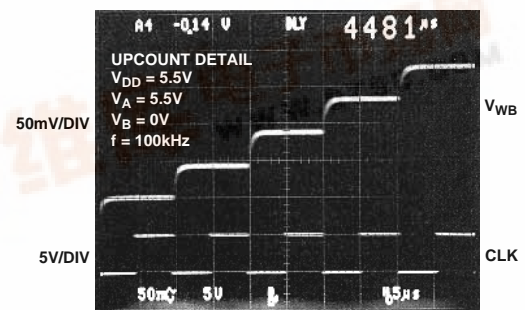

Figure 2a. Stair-Step Increment Output

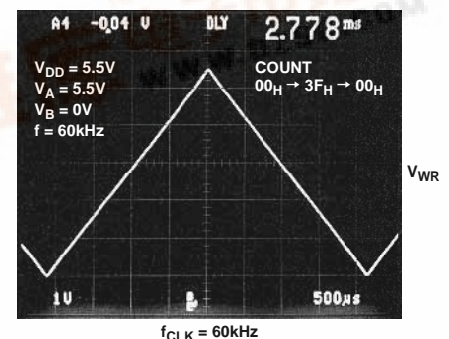

Figure 2b. Full-Scale Up/Down Count

REV. 0

Information furnished by Analog Devices is believed to be accurate and reliable. However, no responsibility is assumed by Analog Devices for its use, nor for any infringements of patents or other rights of third parties which may result from its use. No license is granted by implication or otherwise under any patent or patent rights of Analog Devices.

AD5220—SPECIFICATIONS

ELECTRICAL CHARACTERISTICS ($V_{DD} = +3\text{ V} \pm 10\%$ or $+5\text{ V} \pm 10\%$, $V_A = +V_{DD}$, $V_B = 0\text{ V}$, $-40^\circ\text{C} < T_A < +85^\circ\text{C}$ unless otherwise noted)

Parameter	Symbol	Conditions	Min	Typ ¹	Max	Units
DC CHARACTERISTICS RHEOSTAT MODE Specifications Apply to All VRs						
Resistor Differential NL ²	R-DNL	R_{WB} , $V_A = \text{NC}$, $R_{AB} = 10\text{ k}\Omega$	-1	± 0.4	+1	LSB
Resistor Nonlinearity ²	R-INL	R_{WB} , $V_A = \text{NC}$, $R_{AB} = 50\text{ k}\Omega$ or $100\text{ k}\Omega$	-0.5	± 0.1	+0.5	LSB
		R_{WB} , $V_A = \text{NC}$, $R_{AB} = 10\text{ k}\Omega$	-1	± 0.5	+1	LSB
Nominal Resistor Tolerance	ΔR	R_{WB} , $V_A = \text{NC}$, $R_{AB} = 50\text{ k}\Omega$ or $100\text{ k}\Omega$	-0.5	± 0.1	+0.5	LSB
Resistance Temperature Coefficient	$\Delta R_{AB}/\Delta T$	$T_A = +25^\circ\text{C}$	-30		+30	%
Wiper Resistance	R_W	$V_{AB} = V_{DD}$, Wiper = No Connect		800		ppm/ $^\circ\text{C}$
		$I_W = V_{DD}/R$, $V_{DD} = +3\text{ V}$ or $+5\text{ V}$		40	100	Ω
DC CHARACTERISTICS POTENTIOMETER DIVIDER MODE Specifications Apply to All VRs						
Resolution	N		7			Bits
Integral Nonlinearity ³	INL	$R_{AB} = 10\text{ k}\Omega$	-1	± 0.5	+1	LSB
		$R_{AB} = 50\text{ k}\Omega$, $100\text{ k}\Omega$	-0.5	± 0.2	+0.5	LSB
Differential Nonlinearity Error ³	DNL	$R_{AB} = 10\text{ k}\Omega$	-1	± 0.4	+1	LSB
		$R_{AB} = 50\text{ k}\Omega$, $100\text{ k}\Omega$	-0.5	± 0.1	+0.5	LSB
Voltage Divider Temperature Coefficient	$\Delta V_W/\Delta T$	Code = 40 _H		20		ppm/ $^\circ\text{C}$
Full-Scale Error	V_{WFSE}	Code = 7F _H	-2	-0.5	0	LSB
Zero-Scale Error	V_{WZSE}	Code = 00 _H	0	+0.5	+1	LSB
RESISTOR TERMINALS						
Voltage Range ⁴	V_A , V_B , V_W		0		V_{DD}	V
Capacitance ⁵ A, B	C_A , C_B	$f = 1\text{ MHz}$, Measured to GND, Code = 40 _H		10		pF
Capacitance ⁵ W	C_W	$f = 1\text{ MHz}$, Measured to GND, Code = 40 _H		48		pF
Common-Mode Leakage	I_{CM}	$V_A = V_B = V_W$		7.5		nA
DIGITAL INPUTS AND OUTPUTS						
Input Logic High	V_{IH}	$V_{DD} = +5\text{ V}/+3\text{ V}$	2.4/2.1			V
Input Logic Low	V_{IL}	$V_{DD} = +5\text{ V}/+3\text{ V}$			0.8/0.6	V
Input Current	I_{IL}	$V_{IN} = 0\text{ V}$ or $+5\text{ V}$			± 1	μA
Input Capacitance ⁵	C_{IL}			5		pF
POWER SUPPLIES						
Power Supply Range	V_{DD}		2.7		5.5	V
Supply Current	I_{DD}	$V_{IH} = +5\text{ V}$ or $V_{IL} = 0\text{ V}$, $V_{DD} = +5\text{ V}$		15	40	μA
Power Dissipation ⁶	P_{DISS}	$V_{IH} = +5\text{ V}$ or $V_{IL} = 0\text{ V}$, $V_{DD} = +5\text{ V}$		75	200	μW
Power Supply Sensitivity	PSS			0.004	0.015	%/%
DYNAMIC CHARACTERISTICS^{5, 7, 8}						
Bandwidth -3 dB	BW_10K	$R_{AB} = 10\text{ k}\Omega$, Code = 40 _H		650		kHz
	BW_50K	$R_{AB} = 50\text{ k}\Omega$, Code = 40 _H		142		kHz
	BW_100K	$R_{AB} = 100\text{ k}\Omega$, Code = 40 _H		69		kHz
Total Harmonic Distortion	THD _W	$V_A = 1\text{ V rms} + 2.5\text{ V dc}$, $V_B = 2.5\text{ V dc}$, $f = 1\text{ kHz}$		0.002		%
V_W Settling Time	t_S	$V_A = V_{DD}$, $V_B = 0\text{ V}$, 50% of Final Value, 10K/50K/100K		0.6/3/6		μs
Resistor Noise Voltage	e_{NWB}	$R_{WB} = 5\text{ k}\Omega$, $f = 1\text{ kHz}$		14		$\text{nV}/\sqrt{\text{Hz}}$
INTERFACE TIMING CHARACTERISTICS Applies to All Parts ^{5, 9}						
Input Clock Pulsewidth	t_{CH} , t_{CL}	Clock Level High or Low	25			ns
$\overline{\text{CS}}$ to CLK Setup Time	t_{CSS}		20			ns
$\overline{\text{CS}}$ Rise to Clock Hold Time	t_{CSH}		20			ns
$\text{U}/\overline{\text{D}}$ to Clock Fall Setup Time	t_{UDS}		10			ns

NOTES

¹Typicals represent average readings at $+25^\circ\text{C}$ and $V_{DD} = +5\text{ V}$.

²Resistor position nonlinearity error R-INL is the deviation from an ideal value measured between the maximum resistance and the minimum resistance wiper positions. R-DNL measures the relative step change from ideal between successive tap positions. Parts are guaranteed monotonic. See Figure 29 test circuit.

³INL and DNL are measured at V_W with the RDAC configured as a potentiometer divider similar to a voltage output D/A converter. $V_A = V_{DD}$ and $V_B = 0\text{ V}$. DNL specification limits of ± 1 LSB maximum are guaranteed monotonic operating conditions. See Figure 28 test circuit.

⁴Resistor terminals A, B, W have no limitations on polarity with respect to each other.

⁵Guaranteed by design and not subject to production test.

⁶ P_{DISS} is calculated from $(I_{DD} \times V_{DD})$. CMOS logic level inputs result in minimum power dissipation.

⁷Bandwidth, noise and settling time are dependent on the terminal resistance value chosen. The lowest R value results in the fastest settling time and highest bandwidth. The highest R value results in the minimum overall power consumption.

⁸All dynamic characteristics use $V_{DD} = +5\text{ V}$.

⁹See timing diagrams for location of measured values. All input control voltages are specified with $t_R = t_F = 1\text{ ns}$ (10% to 90% of V_{DD}) and timed from a voltage level of 1.6 V. Switching characteristics are measured using both $V_{DD} = +3\text{ V}$ or $+5\text{ V}$.

Specifications subject to change without notice.

ABSOLUTE MAXIMUM RATINGS*

(T_A = +25°C, unless otherwise noted)

V _{DD} to GND-0.3 V, +7 V
V _A , V _B , V _W to GND 0 V, V _{DD}
A _X -B _X , A _X -W _X , B _X -W _X ±20 mA
Digital Input Voltage to GND 0 V, V _{DD} + 0.3 V
Operating Temperature Range -40°C to +85°C
Maximum Junction Temperature (T _J MAX) +150°C
Storage Temperature -65°C to +150°C
Lead Temperature (Soldering, 10 sec) +300°C
Package Power Dissipation (T _J max-T _A)/θ _{JA}
Thermal Resistance θ _{JA}	
P-DIP (N-8) 103°C/W
SOIC (SO-8) 158°C/W
μSOIC (RM-8) 206°C/W

*Stresses above those listed under Absolute Maximum Ratings may cause permanent damage to the device. This is a stress rating only; functional operation of the device at these or any other conditions above those indicated in the operational sections of this specification is not implied. Exposure to absolute maximum rating conditions for extended periods may affect device reliability.

Table I. Truth Table

\overline{CS}	CLK	U/ \overline{D}	Operation
L	↓	H	Wiper Increment Toward Terminal A
L	↓	L	Wiper Decrement Toward Terminal B
H	X	X	Wiper Position Fixed

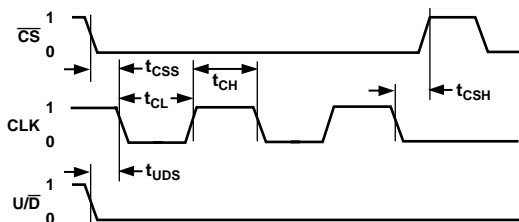
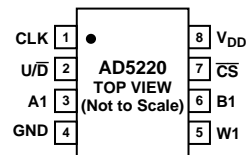

Figure 3. Detail Timing Diagram

PIN CONFIGURATION



PIN FUNCTION DESCRIPTIONS

Pin No.	Name	Description
1	CLK	Serial Clock Input, Negative Edge Triggered
2	U/ \overline{D}	UP/DOWN Direction Increment Control
3	A1	Terminal A1
4	GND	Ground
5	W1	Wiper Terminal
6	B1	Terminal B1
7	\overline{CS}	Chip Select Input, Active Low
8	V _{DD}	Positive Power Supply

ORDERING GUIDE

Model	kΩ	Temperature Range	Package Descriptions	Package Options
AD5220BN10	10	-40°C to +85°C	8-Lead Plastic DIP	N-8
AD5220BR10	10	-40°C to +85°C	8-Lead (SOIC)	SO-8
AD5220BRM10	10	-40°C to +85°C	8-Lead μSOIC	RM-8
AD5220BN50	50	-40°C to +85°C	8-Lead Plastic DIP	N-8
AD5220BR50	50	-40°C to +85°C	8-Lead (SOIC)	SO-8
AD5220BRM50	50	-40°C to +85°C	8-Lead μSOIC	RM-8
AD5220BN100	100	-40°C to +85°C	8-Lead Plastic DIP	N-8
AD5220BR100	100	-40°C to +85°C	8-Lead (SOIC)	SO-8
AD5220BRM100	100	-40°C to +85°C	8-Lead μSOIC	RM-8

NOTE

The AD5220 die size is 37 mil × 54 mil, 1998 sq mil; 0.938 mm × 1.372 mm, 1.289 sq mm. Contains 754 transistors. Patent Number 5495245 applies.

CAUTION

ESD (electrostatic discharge) sensitive device. Electrostatic charges as high as 4000 V readily accumulate on the human body and test equipment and can discharge without detection. Although the AD5220 features proprietary ESD protection circuitry, permanent damage may occur on devices subjected to high energy electrostatic discharges. Therefore, proper ESD precautions are recommended to avoid performance degradation or loss of functionality.



AD5220—Typical Performance Characteristics

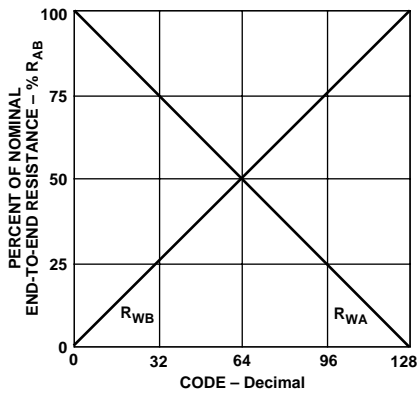

Figure 4. Wiper to End Terminal Resistance vs. Code

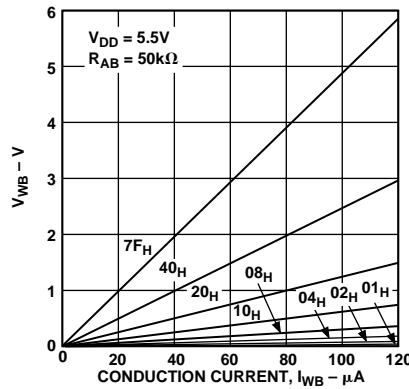

Figure 5. Resistance Linearity vs. Conduction Current

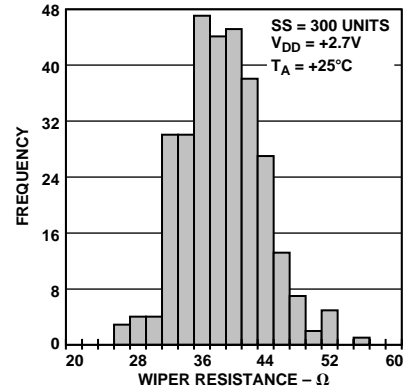

Figure 6. Wiper Contact Resistance

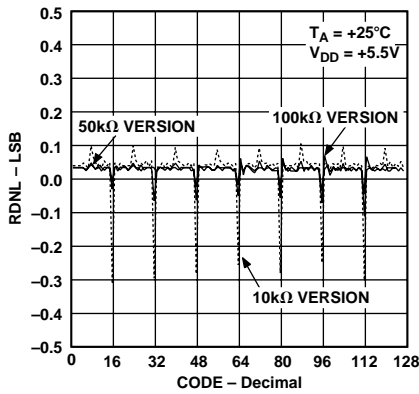

Figure 7. R-DNL Relative Resistance Step Position Nonlinearity Error vs. Code

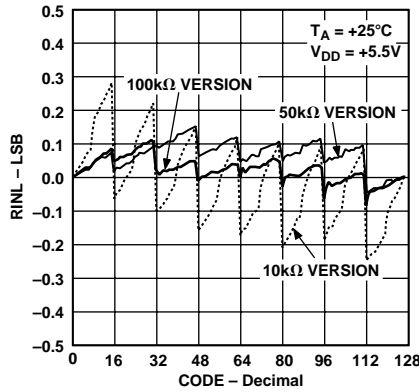

Figure 8. R-INL Resistance Nonlinearity Error vs. Supply Voltage

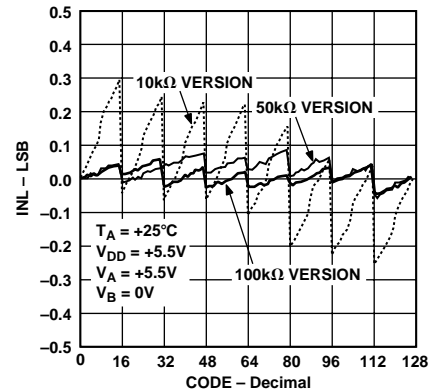

Figure 9. Potentiometer Divider INL Error vs. Code

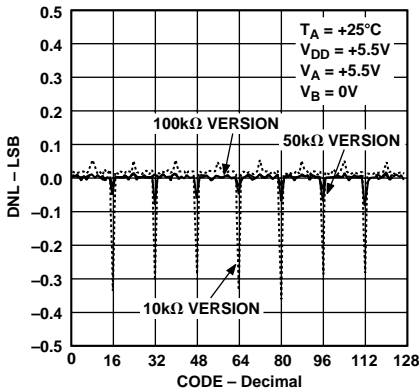

Figure 10. Potentiometer Divider DNL Error vs. Code

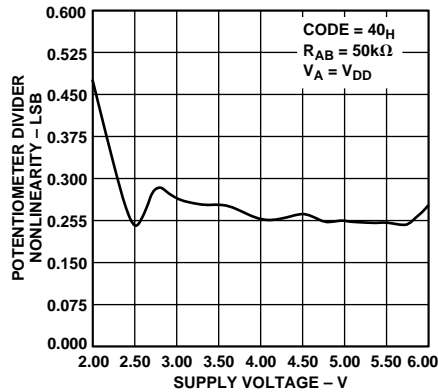

Figure 11. Potentiometer Divider INL Error vs. Supply Voltage

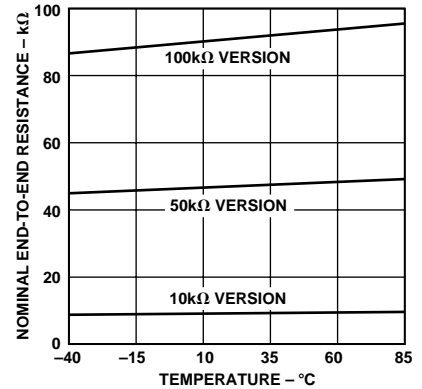

Figure 12. Nominal Resistance vs. Temperature

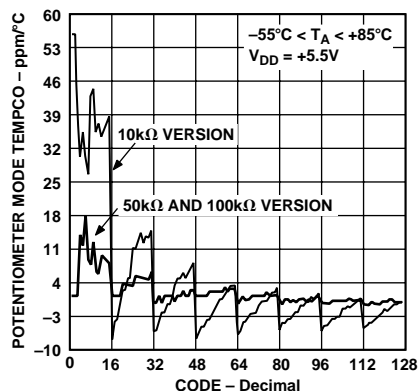

Figure 13. $\Delta V_{WB}/\Delta T$ Potentiometer Mode Tempco (10 k Ω and 50 k Ω)

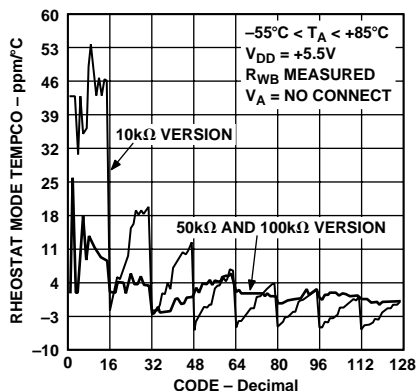

Figure 14. $\Delta R_{WB}/\Delta T$ Rheostat

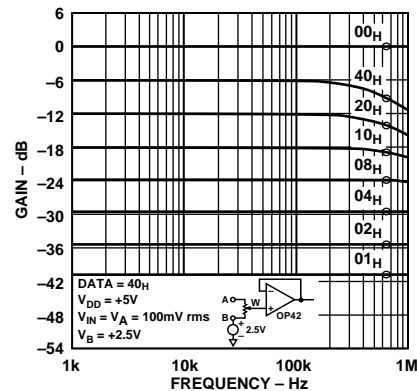

Figure 15. 10 k Ω Gain vs. Frequency vs. Code

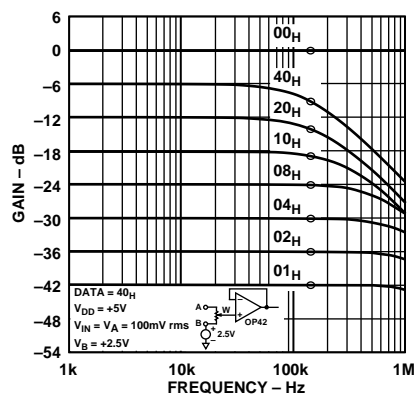

Figure 16. 50 k Ω Gain vs. Frequency vs. Code

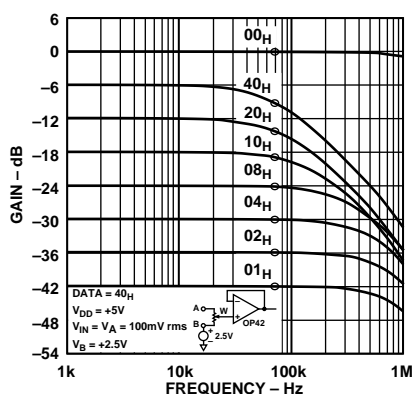

Figure 17. 100 k Ω Gain vs. Frequency vs. Code

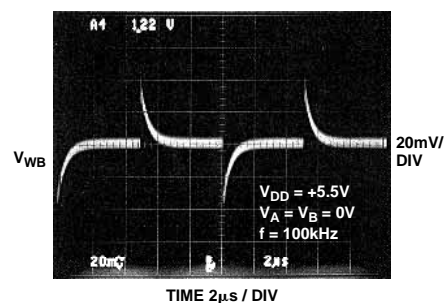

Figure 18. Digital Feedthrough

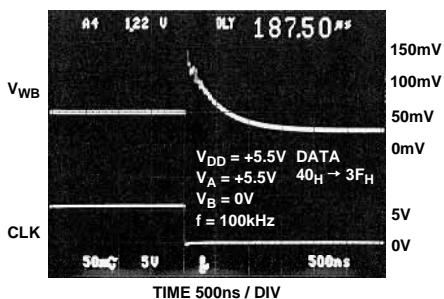

Figure 19. Midscale Transition Glitch

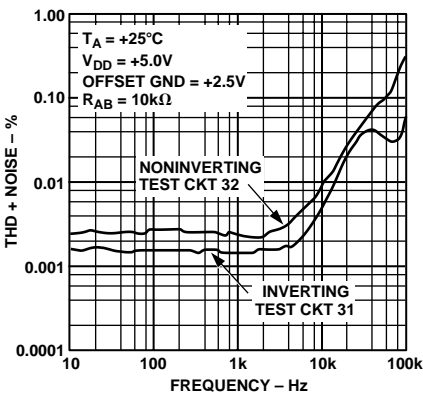

Figure 20. Total Harmonic Distortion Plus Noise vs. Frequency

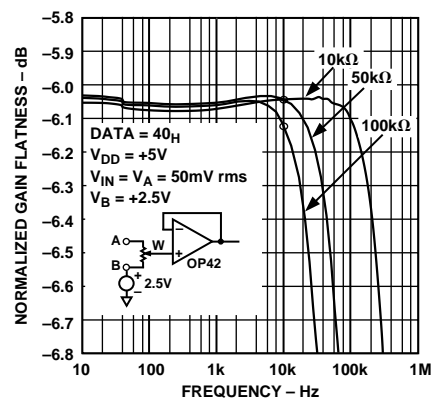

Figure 21. Normalized Gain Flatness vs. Frequency

AD5220

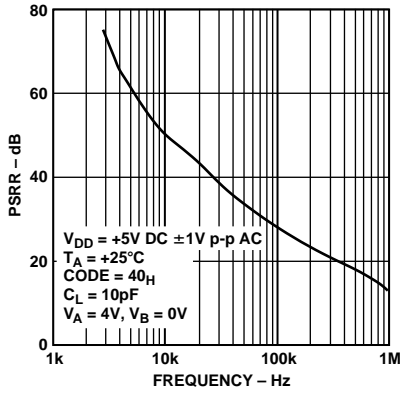

Figure 22. Power Supply Rejection vs. Frequency

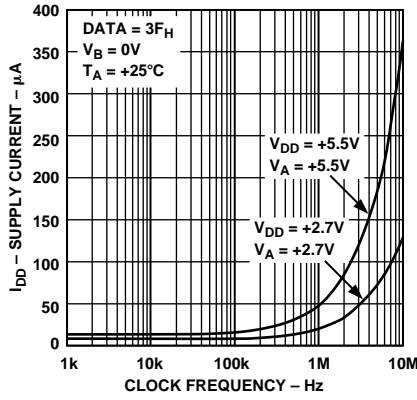

Figure 23. I_{DD} Supply Current vs. Clock Frequency

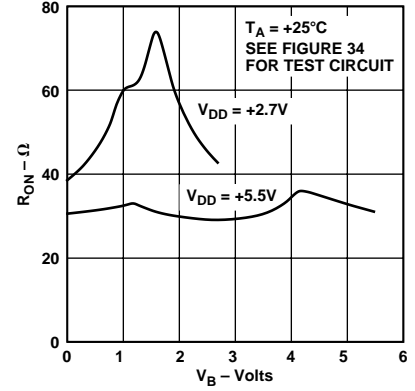

Figure 24. Incremental Wiper Contact Resistance vs. V_B

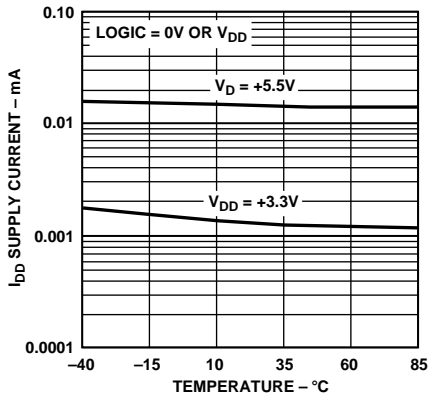

Figure 25. Supply Current vs. Temperature I_{DD}

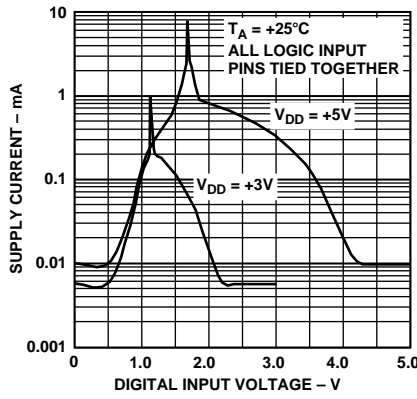

Figure 26. Supply Current vs. Input Logic Voltage

Parametric Test Circuits—AD5220

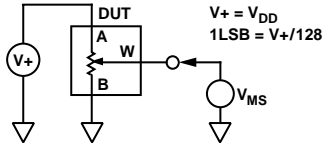

Figure 27. Potentiometer Divider Nonlinearity Error Test Circuit (INL, DNL)

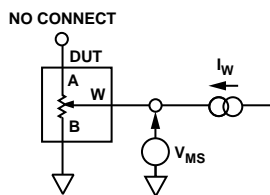

Figure 28. Resistor Position Nonlinearity Error (Rheostat Operation; R-INL, R-DNL)

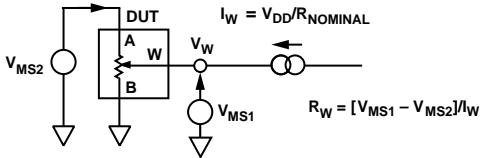

Figure 29. Wiper Resistance Test Circuit

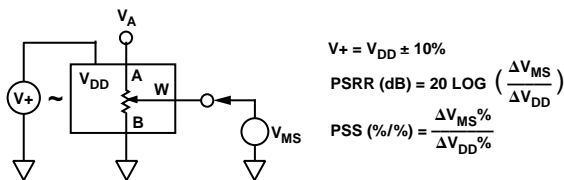

Figure 30. Power Supply Sensitivity Test Circuit (PSS, PSRR)

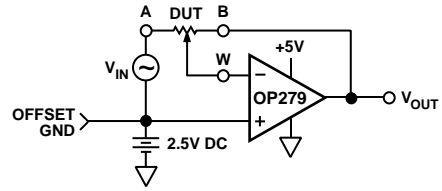

Figure 31. Inverting Programmable Gain Test Circuit

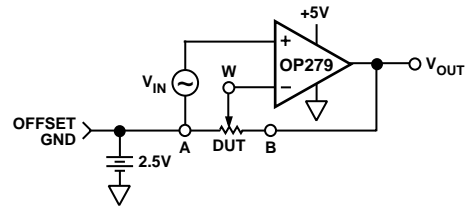

Figure 32. Noninverting Programmable Gain Test Circuit

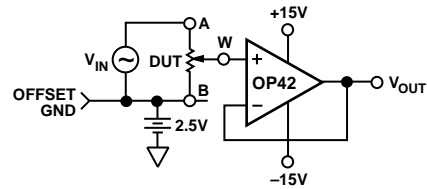

Figure 33. Gain vs. Frequency Test Circuit

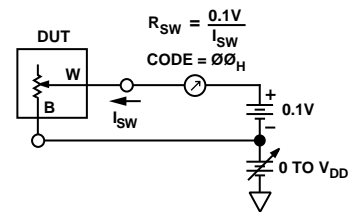

Figure 34. Incremental ON Resistance Test Circuit

AD5220

OPERATION

The AD5220 provides a 128-position digitally controlled variable resistor (VR) device. Changing the VR settings is accomplished by pulsing the CLK pin while \overline{CS} is active low. The direction of the increment is controlled by the U/\overline{D} (UP/DOWN) control input pin. When the wiper hits the end of the resistor (Terminals A or B) additional CLK pulses no longer change the wiper setting. The wiper position is immediately decoded by the wiper decode logic changing the wiper resistance. Appropriate debounce circuitry is required when push button switches are used to control the count sequence and direction of count. The exact timing requirements are shown in Figure 3. The AD5220 powers ON in a centered wiper position exhibiting nearly equal resistances of R_{WA} and R_{WB} .

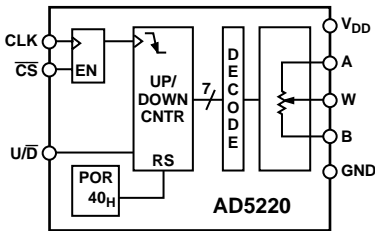

Figure 35. Block Diagram

DIGITAL INTERFACING OPERATION

The AD5220 contains a three-wire serial input interface. The three inputs are clock (CLK), \overline{CS} and UP/DOWN (U/\overline{D}). The negative-edge sensitive CLK input requires clean transitions to avoid clocking multiple pulses into the internal UP/DOWN counter register, see Figure 35. Standard logic families work well. If mechanical switches are used for product evaluation they should be debounced by a flip-flop or other suitable means. When \overline{CS} is taken active low the clock begins to increment or decrement the internal UP/DOWN counter dependent upon the state of the U/\overline{D} control pin. The UP/DOWN counter value (D) starts at 40_H at system power ON. Each new CLK pulse will increment the value of the internal counter by one LSB until the full scale value of 3F_H is reached as long as the U/\overline{D} pin is logic high. If the U/\overline{D} pin is taken to logic low the counter will count down stopping at code 00_H (zero-scale). Additional clock pulses on the CLK pin are ignored when the wiper is at either the 00_H position or the 3F_H position.

All digital inputs (\overline{CS} , U/\overline{D} , CLK) are protected with a series input resistor and parallel Zener ESD structure shown in Figure 36.

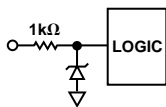

Figure 36. Equivalent ESD Protection Digital Pins

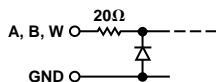

Figure 37. Equivalent ESD Protection Analog Pins

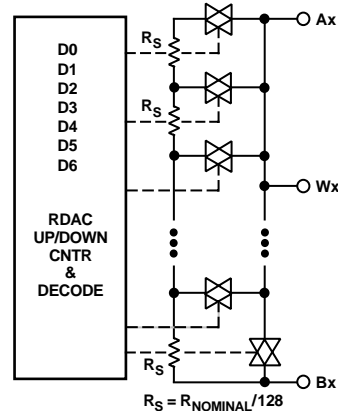

Figure 38. AD5220 Equivalent RDAC Circuit

PROGRAMMING THE VARIABLE RESISTOR

Rheostat Operation

The nominal resistance of the RDAC between terminals A and B is available with values of 10 kΩ, 50 kΩ, and 100 kΩ. The final three characters of the part number determine the nominal resistance value, e.g., 10 kΩ = 10; 50 kΩ = 50; 100 kΩ = 100. The nominal resistance (R_{AB}) of the VR has 128 contact points accessed by the wiper terminal, plus the B terminal contact. At power ON the resistance from the wiper to either end Terminal A or B is approximately equal. Clocking the CLK pin will increase the resistance from the Wiper W to Terminal B by one unit of R_S resistance (see Figure 38). The resistance R_{WB} is determined by the number of pulses applied to the clock pin. Each segment of the internal resistor string has a nominal resistance value of $R_S = R_{AB}/128$, which becomes 78 Ω in the case of the 10 kΩ AD5220BN10 product. Care should be taken to limit the current flow between W and B in the direct contact state to a maximum value of 5 mA to avoid degradation or possible destruction of the internal switch contact.

Like the mechanical potentiometer the RDAC replaces, it is totally symmetrical (see Figure 38). The resistance between the Wiper W and Terminal A also produces a digitally controlled resistance R_{WA} . When these terminals are used the B-terminal should be tied to the wiper.

The typical part-to-part distribution of R_{BA} is process lot dependent having a $\pm 30\%$ variation. The change in R_{BA} with temperature has a 800 ppm/°C temperature coefficient.

The R_{BA} temperature coefficient increases as the wiper is programmed near the B-terminal due to the larger percentage contribution of the wiper contact switch resistance, which has a 0.5%/°C temperature coefficient. Figure 14 shows the effect of the wiper contact resistance as a function of code setting. Another performance factor influenced by the switch contact resistance is the relative linearity error performance between the 10 kΩ, and the 50 kΩ or 100 kΩ versions. The same switch contact resistance is used in all three versions. Thus the performance of the 50 kΩ and 100 kΩ devices which have the least impact on wiper switch resistance exhibits the best linearity error, see Figures 7 and 8.

PROGRAMMING THE POTENTIOMETER DIVIDER**Voltage Output Operation**

The digital potentiometer easily generates an output voltage proportional to the input voltage applied to a given terminal. For example connecting A Terminal to +5 V and B Terminal to ground produces an output voltage at the wiper which can be any value starting at zero volts up to 1 LSB less than +5 V. Each LSB of voltage is equal to the voltage applied across terminals AB divided by the 128-position resolution of the potentiometer divider. The general equation defining the output voltage with respect to ground for any given input voltage applied to terminals AB is:

$$V_W(D) = D/128 \times V_{AB} + V_B \quad (1)$$

D represents the current contents of the internal UP/DOWN counter.

Operation of the digital potentiometer in the divider mode results in more accurate operation over temperature. Here the output voltage is dependent on the ratio of the internal resistors, not the absolute value, therefore, the drift improves to 20 ppm/°C.

APPLICATIONS INFORMATION

The negative-edge sensitive CLK pin does not contain any internal debounce circuitry. This standard CMOS logic input responds to fast negative edges and needs to be debounced externally with an appropriate circuit designed for the type of switch closure device being used. Good performance results at the CLK input pin when the negative logic transition has a minimum slew rate of 1 V/μs. A wide variety of standard circuits can be used such as a one-shot multivibrator, Schmitt Triggered gates, cross coupled flip-flops, or RC filters to drive the CLK pin with uniform negative edges. This will prevent the digital potentiometer from skipping output codes while counting due to switch contact bounce.

AD5220

OUTLINE DIMENSIONS

Dimensions shown in inches and (mm).

8-Lead Plastic DIP (N-8)

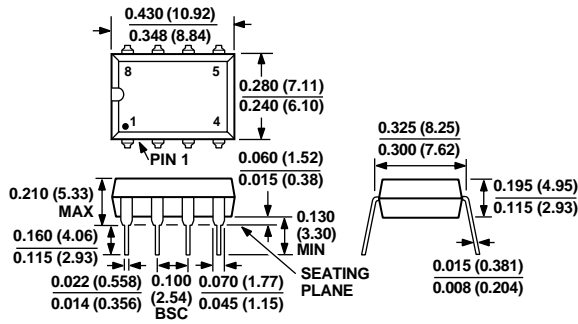

8-Lead SOIC (SO-8)

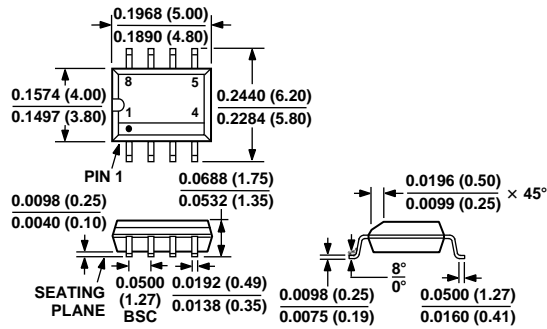

8-Lead μ SOIC (RM-8)

