



# AF9412N

## N-Channel 30-V (D-S) MOSFET

### ■ Features

- Low  $r_{DS(on)}$  Provides Higher Efficiency and Extends Battery Life
- Miniature SO-8 Surface Mount Package Saves Board Space
- High power and current handling capability
- Low side high current DC-DC Converter applications

### ■ General Description

These miniature surface mount MOSFETs utilize High Cell Density process. Low  $r_{DS(on)}$  assures minimal power loss and conserves energy, making this device ideal for using in the power management circuitry. Typical applications are PWM DC-DC converters, power management in portable and battery-powered products such as computers, printers, battery chargers, telecommunication power systems, and telephone power systems.

### ■ Product Summary

$V_{DS}$ (V)	$r_{DS(on)}$ (m $\Omega$ )	$I_D$ (A)
30	22@ $V_{GS}=10V$	9.0
	36@ $V_{GS}=4.5V$	7.0

### ■ Pin Assignments

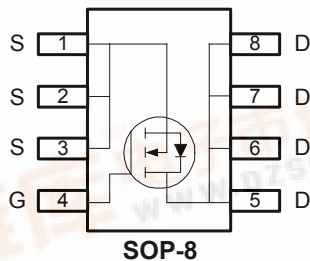

### ■ Pin Descriptions

Pin Name	Description
S	Source
G	Gate
D	Drain

### ■ Ordering information

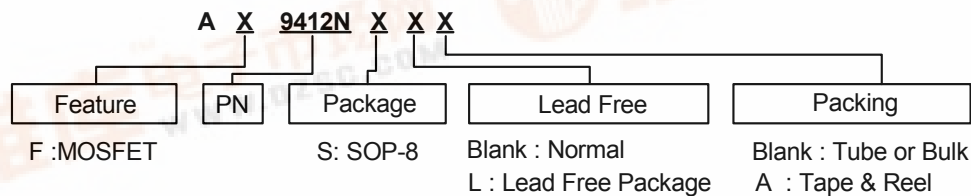



# AF9412N

## N-Channel 30-V (D-S) MOSFET

### ■ Absolute Maximum Ratings ( $T_A=25^\circ\text{C}$ unless otherwise noted)

Symbol	Parameter	Rating	Units
$V_{DS}$	Drain-Source Voltage	30	V
$V_{GS}$	Gate-Source Voltage	$\pm 20$	V
$I_D$	Continuous Drain Current (Note 1)	$T_A=25^\circ\text{C}$	9.4
		$T_A=70^\circ\text{C}$	7.4
$I_{DM}$	Pulsed Drain Current (Note 2)	30	A
$I_S$	Continuous Source Current (Diode Conduction) (Note 1)	1.6	A
$P_D$	Power Dissipation (Note 1)	$T_A=25^\circ\text{C}$	3.1
		$T_A=70^\circ\text{C}$	2.2
$T_J, T_{STG}$	Operating Junction and Storage Temperature Range	-55 to 150	$^\circ\text{C}$

### ■ Thermal Resistance Ratings

Symbol	Parameter	Maximum	Units
$R_{\theta JC}$	Maximum Junction-to-Case (Note 1)	25	$^\circ\text{C}/\text{W}$
$R_{\theta JA}$	Maximum Junction-to-Ambient (Note 1)	40	

Note 1: surface Mounted on 1"x1" FR4 Board.

Note 2: Pulse width limited by maximum junction temperature

### ■ Specifications ( $T_A=25^\circ\text{C}$ unless otherwise noted)

Symbol	Parameter	Test Conditions	Limits			Unit
			Min.	Typ.	Max.	
<b>Static</b>						
$V_{(BR)DSS}$	Drain-Source Breakdown Voltage	$V_{GS}=0\text{V}, I_D=250\mu\text{A}$	30	-	-	V
$V_{GS(th)}$	Gate-Threshold Voltage	$V_{DS}=V_{GS}, I_D=250\mu\text{A}$	1	1.95	3.0	V
$I_{GSS}$	Gate-Body Leakage	$V_{DS}=0\text{V}, V_{GS}=20\text{V}$	-	-	$\pm 100$	nA
$I_{DSS}$	Zero Gate Voltage Drain Current	$V_{DS}=24\text{V}, V_{GS}=0\text{V}$	-	-	1	uA
		$V_{DS}=24\text{V}, V_{GS}=0\text{V}, T_J=55^\circ\text{C}$	-	-	25	
$I_{D(on)}$	On-State Drain Current (Note 3)	$V_{DS}=5\text{V}, V_{GS}=10\text{V}$	20	-	-	A
$r_{DS(on)}$	Drain-Source On-Resistance (Note 3)	$V_{GS}=10\text{V}, I_D=9.2\text{A}$	-	17	22	m $\Omega$
		$V_{GS}=4.5\text{V}, I_D=8\text{A}$	-	29	36	
		$V_{GS}=10\text{V}, I_D=9.2\text{A}, T_J=55^\circ\text{C}$	-	20	27	
$g_{fs}$	Forward Transconductance (Note 3)	$V_{DS}=15\text{V}, I_D=9.2\text{A}$	-	40	-	S
$V_{SD}$	Diode Forward Voltage	$I_S=2.3\text{A}, V_{GS}=0\text{V}$	-	0.7	1.1	V
<b>Dynamic (Note 4)</b>						
$Q_g$	Total Gate Charge	$V_{DS}=15\text{V}, V_{GS}=4.5\text{V}, I_D=7\text{A}$	-	4.7	8	nC
$Q_{gs}$	Gate-Source Charge		-	1.7	-	
$Q_{gd}$	Gate-Drain Charge		-	1.4	-	
<b>Switching</b>						
$t_{d(on)}$	Turn-On Delay Time	$V_{DD}=25\text{V}, R_L=25\Omega, I_D=1\text{A}, V_{GEN}=10\text{V}$	-	16	21	nS
$t_r$	Rise Time		-	5	10	
$t_{d(off)}$	Turn-Off Delay Time		-	23	37	
$t_f$	Fall-Time		-	3	6	
$t_{rr}$	Source-Drain Reverse Recovery Time	$I_F=2.3\text{A}, Di/Dt=100\text{A}/\mu\text{S}$	-	41	80	nS

Note 3: Pulse test:  $PW \leq 300\mu\text{s}$  duty cycle  $\leq 2\%$ .

Note 4: Guaranteed by design, not subject to production testing.

## N-Channel 30-V (D-S) MOSFET

### ■ Typical Performance Characteristics

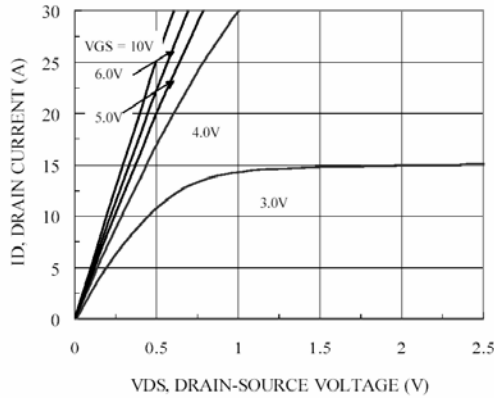

Figure 1. On-Region Characteristics

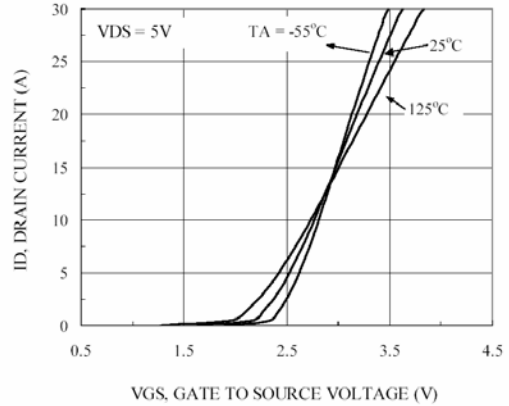

Figure 2. Body Diode Forward Voltage Variation with Source Current and Temperature

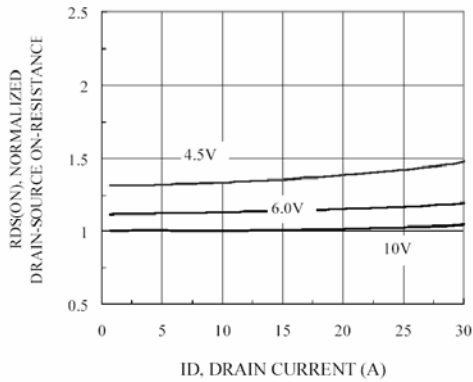

Figure 3. On Resistance Vs Vgs Voltage

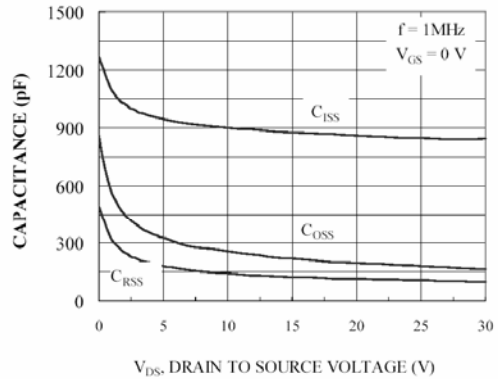

Figure 4. Capacitance Characteristics

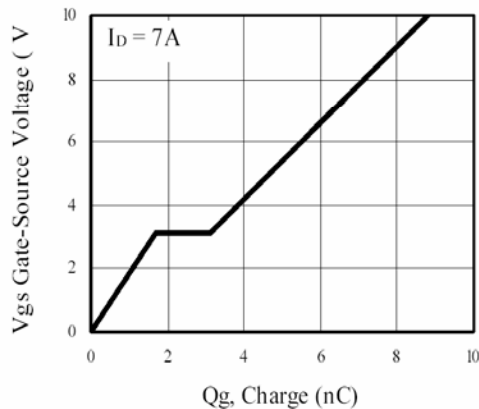

Figure 5. Gate Charge Characteristics

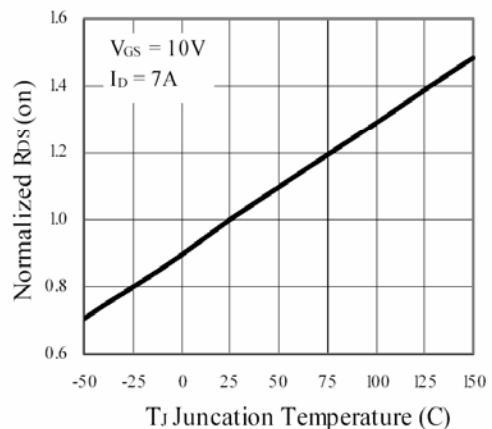

Figure 6. On-Resistance Variation with Temperature

## N-Channel 30-V (D-S) MOSFET

### Typical Performance Characteristics (Continued)

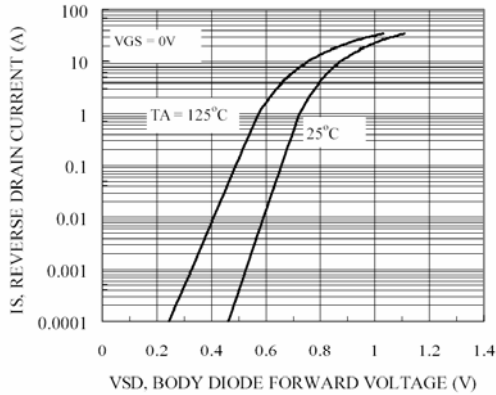

Figure 7. Transfer Characteristics

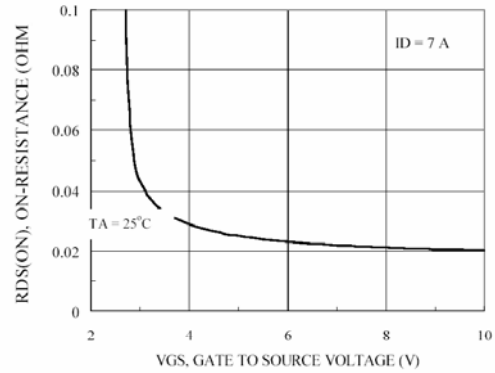

Figure 8. On-Resistance with Gate to Source Voltage

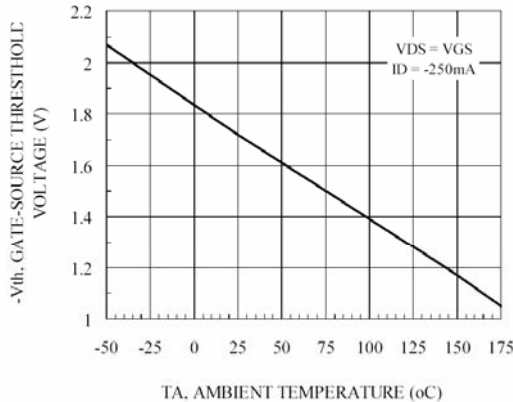

Figure 9. Vth Gate to Source Voltage Vs Temperature

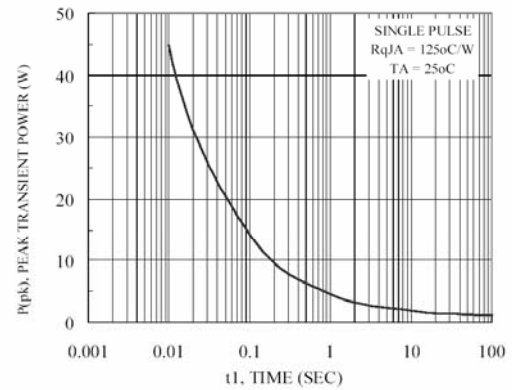

Figure 10. Single Pulse Maximum Power Dissipation

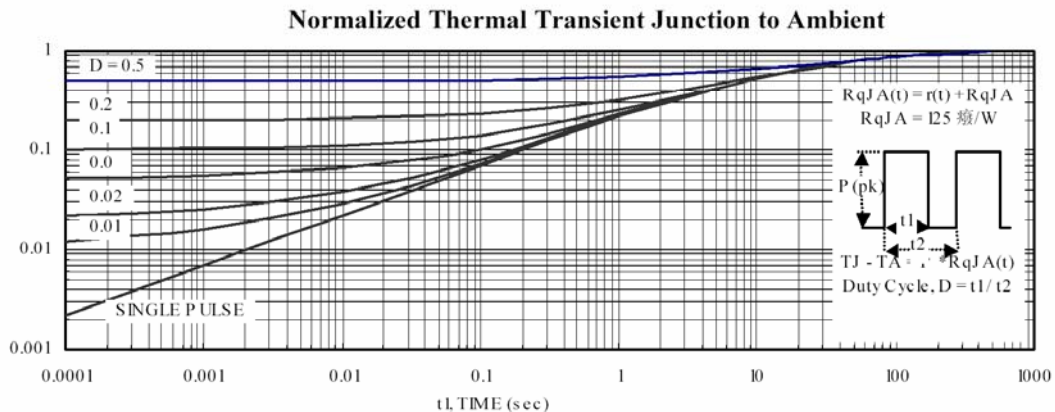
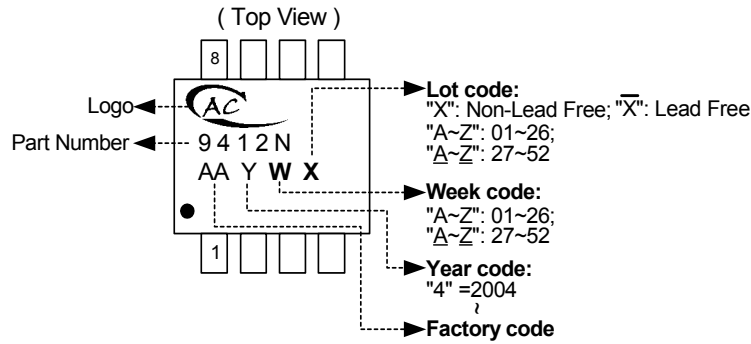

Figure 11. Transient Thermal Response Curve

## N-Channel 30-V (D-S) MOSFET

### ■ Marking Information

SOP-8L



### ■ Package Information

Package Type: SOP-8L

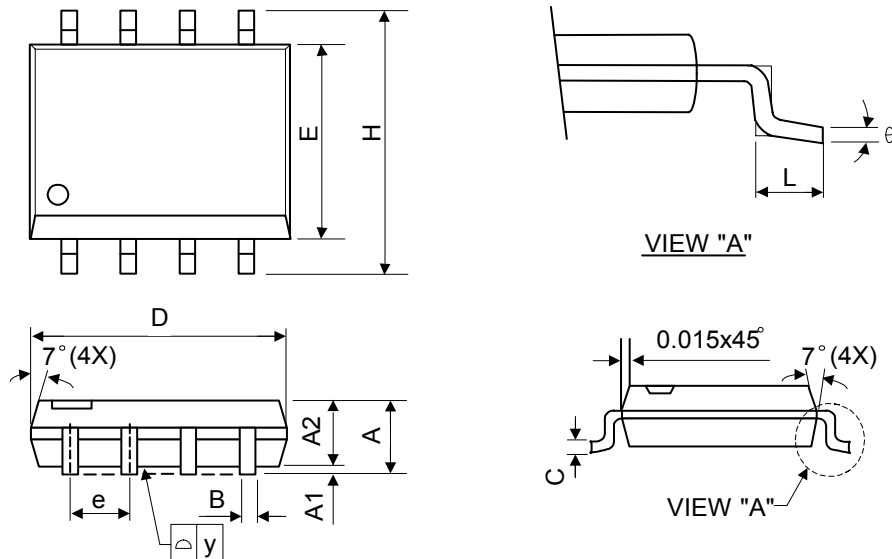

Symbol	Dimensions In Millimeters			Dimensions In Inches		
	Min.	Nom.	Max.	Min.	Nom.	Max.
A	1.40	1.60	1.75	0.055	0.063	0.069
A1	0.10	-	0.25	0.040	-	0.100
A2	1.30	1.45	1.50	0.051	0.057	0.059
B	0.33	0.41	0.51	0.013	0.016	0.020
C	0.19	0.20	0.25	0.0075	0.008	0.010
D	4.80	5.05	5.30	0.189	0.199	0.209
E	3.70	3.90	4.10	0.146	0.154	0.161
e	-	1.27	-	-	0.050	-
H	5.79	5.99	6.20	0.228	0.236	0.244
L	0.38	0.71	1.27	0.015	0.028	0.050
y	-	-	0.10	-	-	0.004
θ	0°	-	8°	0°	-	8°