



AF9903M

2N and 2P-Channel Enhancement Mode Power MOSFET

■ Features

- Simple Drive Requirement
- Low On-Resistance
- Full Bridge Application on LCD Monitor Inverter
- Pb Free Plating Product

■ Product Summary

CH	BV _{DSS} (V)	R _{DS(ON)} (mΩ)	I _D (A)
N	35	48	4.3
P	-35	72	-3.6

■ Pin Assignments

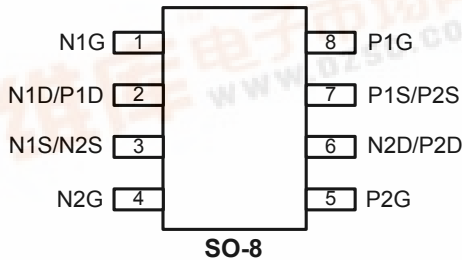

■ General Description

The advanced power MOSFET provides the designer with the best combination of fast switching, ruggedized device design, low on-resistance and cost-effectiveness.

The SO-8 package is universally preferred for all commercial-industrial surface mount applications and suited for low voltage applications such as DC/DC converters.

■ Pin Descriptions

Pin Name	Description
N1G	Gate (NMOS1)
N1D/P1D	Drain(NMOS1) / Drain(PMOS1)
N1S/N2S	Source(NMOS1) / Source(NMOS2)
N2G	Gate (NMOS2)
P2G	Gate (PMOS2)
N2D/P2D	Drain(NMOS2) / Drain(PMOS2)
P1S/P2S	Source(PMOS1) / Source(PMOS2)
P1G	Gate (PMOS1)

■ Ordering information

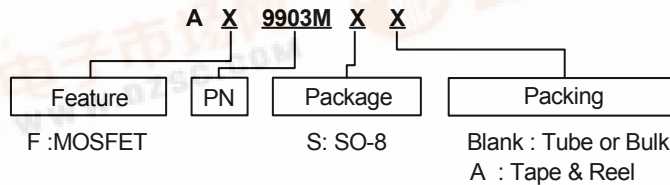

■ Block Diagram

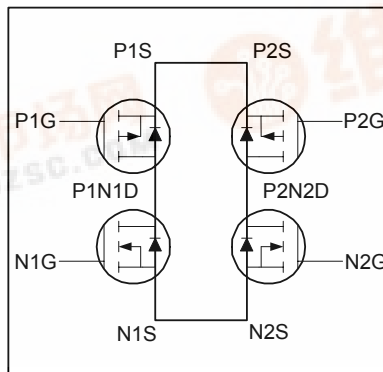



AF9903M

2N and 2P-Channel Enhancement Mode Power MOSFET

■ Absolute Maximum Ratings

Symbol	Parameter	N-Channel	P-Channel	Units	
V_{DS}	Drain-Source Voltage	35	-35	V	
V_{GS}	Gate-Source Voltage	± 20	± 20		
I_D	Continuous Drain Current (Note 1)	$T_A=25^\circ\text{C}$	4.3	-3.6	A
		$T_A=70^\circ\text{C}$	3.4	-2.8	
I_{DM}	Pulsed Drain Current (Note 2)	20	-20	A	
P_D	Total Power Dissipation	$T_A=25^\circ\text{C}$		1.38	W
	Linear Derating Factor			0.01	W/ $^\circ\text{C}$
T_{STG}	Storage Temperature Range			-55 to 150	$^\circ\text{C}$
T_J	Operating Junction Temperature Range			-55 to 150	$^\circ\text{C}$

■ Thermal Data

Symbol	Parameter	Value	Units
$R_{\theta JA}$	Thermal Resistance Junction-Ambient (Note 1)	Max. 90	$^\circ\text{C}/\text{W}$

■ Electrical Characteristics ($T_J=25^\circ\text{C}$ unless otherwise specified)

Symbol	Parameter	Test Conditions	Limits				Unit	
			CH	Min.	Typ.	Max.		
BV_{DSS}	Drain-Source breakdown Voltage	$V_{GS}=0\text{V}, I_D=250\mu\text{A}$	N	35	-	-	V	
		$V_{GS}=0\text{V}, I_D=-250\mu\text{A}$	P	-35	-	-		
$\Delta BV_{DSS}/\Delta T_J$	Breakdown Voltage Temperature Coefficient	Reference to 25°C , $I_D=1\text{mA}$	N	-	0.03	-	$\text{V}/^\circ\text{C}$	
		Reference to 25°C , $I_D=-1\text{mA}$	P	-	-0.02	-		
$R_{DS(ON)}$	Static Drain-Source On-Resistance (Note 3)	$V_{GS}=10\text{V}, I_D=4\text{A}$	N	-	-	48	m Ω	
		$V_{GS}=4.5\text{V}, I_D=3\text{A}$		-	-	70		
		$V_{GS}=-10\text{V}, I_D=-3\text{A}$	P	-	-	72		
		$V_{GS}=-4.5\text{V}, I_D=-2\text{A}$		-	-	100		
$V_{GS(th)}$	Gate-Threshold Voltage	$V_{DS}=V_{GS}, I_D=250\mu\text{A}$	N	1	-	3	V	
		$V_{DS}=V_{GS}, I_D=-250\mu\text{A}$	P	-1	-	-3		
g_{fs}	Forward Transconductance	$V_{DS}=10\text{V}, I_D=4\text{A}$	N	-	8	-	S	
		$V_{DS}=-10\text{V}, I_D=-3\text{A}$	P	-	6	-		
I_{DSS}	Drain-Source Leakage Current	$T_J=25^\circ\text{C}$	N	$V_{DS}=30\text{V}, V_{GS}=0\text{V}$	-	-	1	uA
		$T_J=70^\circ\text{C}$		$V_{DS}=24\text{V}, V_{GS}=0\text{V}$	-	-	25	
		$T_J=25^\circ\text{C}$	P	$V_{DS}=-30\text{V}, V_{GS}=0\text{V}$	-	-	-1	
		$T_J=70^\circ\text{C}$		$V_{DS}=-24\text{V}, V_{GS}=0\text{V}$	-	-	-25	
I_{GSS}	Gate-Source Leakage	$V_{GS}=\pm 20\text{V}$	N	-	-	± 100	nA	
			P	-	-	± 100		
Q_g	Total Gate Charge (Note 3)	N-Channel $V_{DS}=28\text{V}, V_{GS}=4.5\text{V}$	N	-	6	10	nC	
Q_{gs}	Gate-Source Charge	$I_D=4\text{A}$	P	-	6	10		
			N-Channel	N	-	2		-
Q_{gd}	Gate-Drain ("Miller") Charge	$V_{DS}=-28\text{V}, V_{GS}=-4.5\text{V}$ $I_D=-3\text{A}$	P	-	1	-		
			N	-	3	-		
			P	-	3	-		



AF9903M

2N and 2P-Channel Enhancement Mode Power MOSFET

■ Electrical Characteristics ($T_J=25^{\circ}\text{C}$ unless otherwise specified)

Symbol	Parameter	Test Conditions	Limits				Unit
			CH	Min.	Typ.	Max.	
$t_{d(on)}$	Turn-On Delay Time (Note 3)	N-Channel $V_{DS}=15\text{V}, V_{GS}=10\text{V}$	N	-	6	-	ns
			P	-	7	-	
t_r	Rise Time	I _D =1A, R _G =3.3Ω, R _D =15Ω	N	-	5	-	
			P	-	5	-	
$t_{d(off)}$	Turn-Off Delay Time	P-Channel $V_{DS}=-15\text{V}, V_{GS}=-10\text{V}$	N	-	14	-	
			P	-	19	-	
t_f	Fall-Time	I _D =-1A, R _G =3.3Ω, R _D =15Ω	N	-	4	-	
			P	-	4	-	
C_{iss}	Input Capacitance	N-Channel $V_{GS}=0\text{V}, V_{DS}=25\text{V}$	N	-	490	780	pF
			P	-	420	1100	
C_{oss}	Output Capacitance	f=1.0MHz P-Channel	N	-	130	-	
			P	-	140	-	
C_{rss}	Reverse Transfer Capacitance	$V_{GS}=0\text{V}, V_{DS}=-25\text{V}$ f=1.0MHz	N	-	55	-	
			P	-	65	-	

■ Source-Drain Diode

Symbol	Parameter	Test Conditions	Limits				Unit
			CH	Min.	Typ.	Max.	
V_{SD}	Forward On Voltage (Note 3)	$I_S=1.2\text{A}, V_{GS}=0\text{V}$	N	-	-	1.2	V
		$I_S=-1.2\text{A}, V_{GS}=0\text{V}$	P	-	-	-1.2	
t_{rr}	Reverse Recovery Time	N-Channel $I_S=4\text{A}, V_{GS}=0\text{V}$ dI/dt=100A/μs	N	-	18	-	ns
			P	-	20	-	
Q_{rr}	Reverse Recovery Charge	P-Channel $I_S=-3\text{A}, V_{GS}=0\text{V}$ dI/dt=-100A/μs	N	-	11	-	nC
			P	-	16	-	

Note 1: Surface Mounted on 1 in² copper pad of FR4 board; $t \leq 10\text{sec}$; 186°C/W when mounted on Min. copper pad.

Note 2: Pulse width limited by Max. junction temperature

Note 3: Pulse width $\leq 300\mu\text{s}$, duty cycle $\leq 2\%$.

2N and 2P-Channel Enhancement Mode Power MOSFET

■ Typical Performance Characteristics (N-Channel)

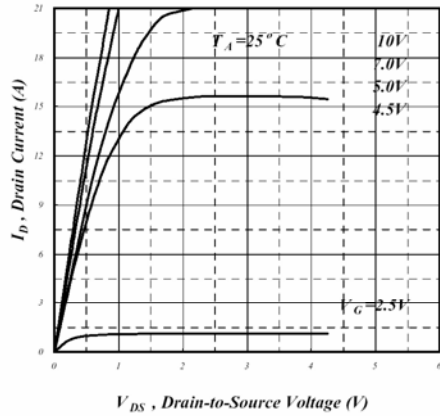

Fig 1. Typical Output Characteristics

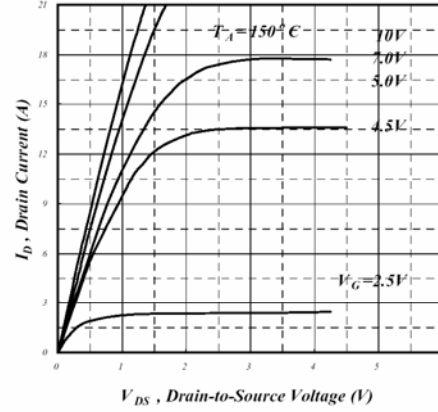

Fig 2. Typical Output Characteristics

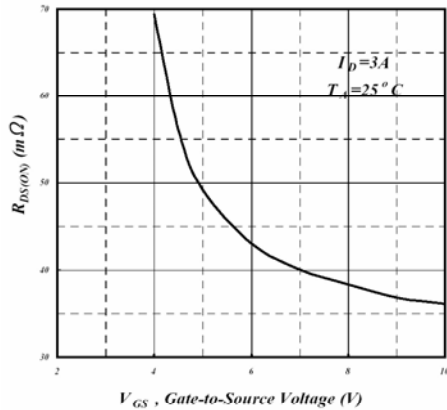

Fig 3. On-Resistance v.s. Gate Voltage

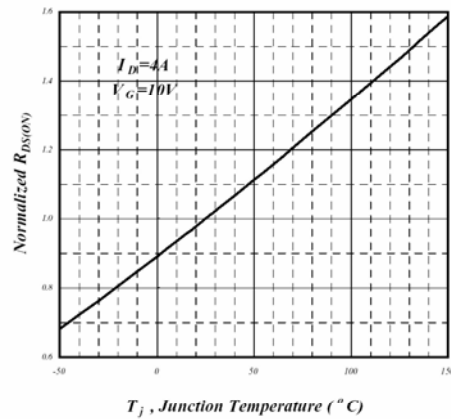

Fig 4. Normalized On-Resistance v.s. Junction Temperature

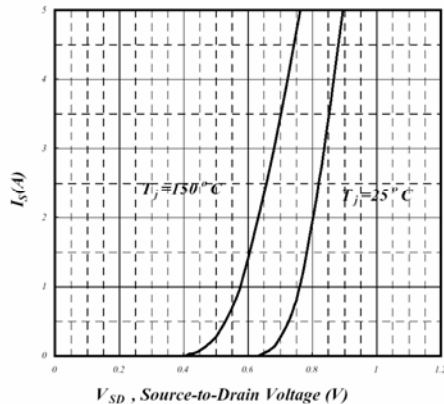

Fig 5. Forward Characteristic of Reverse Diode

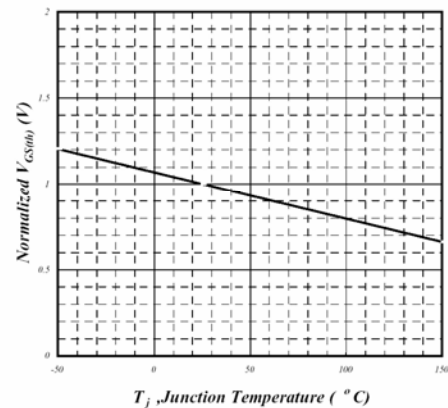

Fig 6. Gate Threshold Voltage v.s. Junction Temperature

2N and 2P-Channel Enhancement Mode Power MOSFET

■ Typical Performance Characteristics (N-Channel) (Continued)

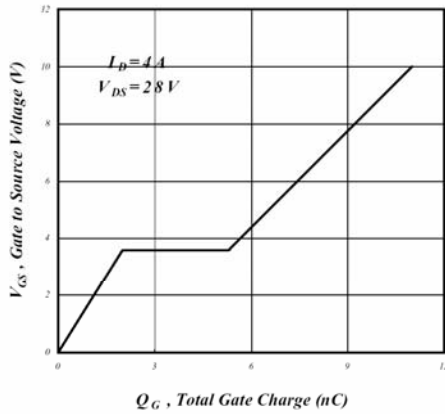

Fig 7. Gate Charge Characteristics

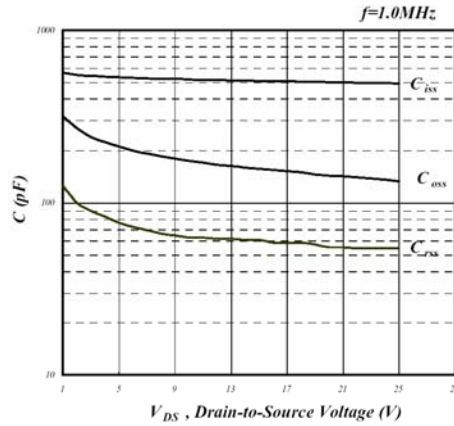

Fig 8. Typical Capacitance Characteristics

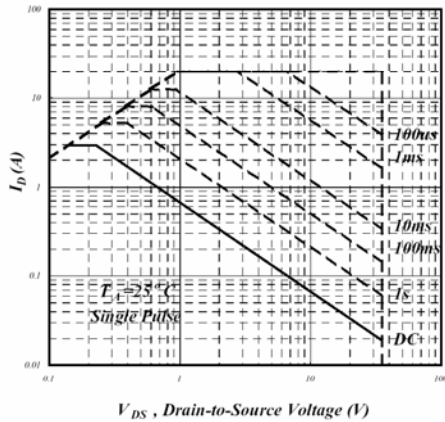

Fig 9. Maximum Safe Operating Area

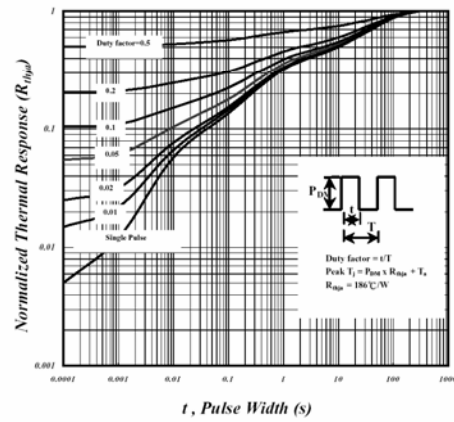

Fig 10. Effective Transient Thermal Impedance

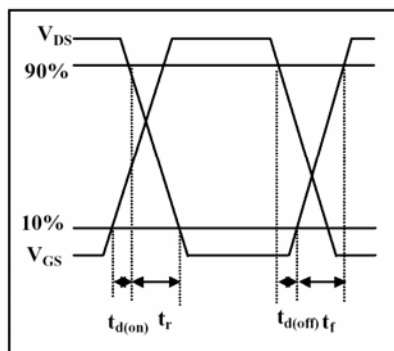

Fig 11. Switching Time Waveform

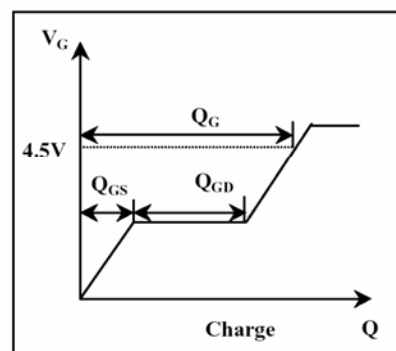

Fig 12. Gate Charge Waveform

2N and 2P-Channel Enhancement Mode Power MOSFET

■ Typical Performance Characteristics (P-Channel)

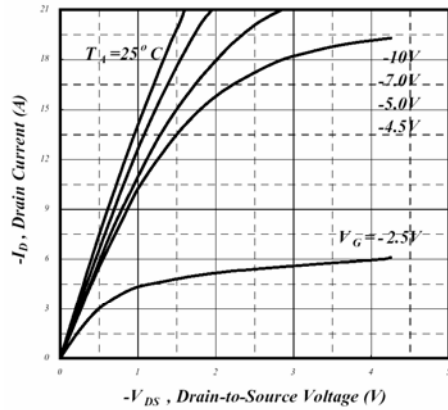

Fig 1. Typical Output Characteristics

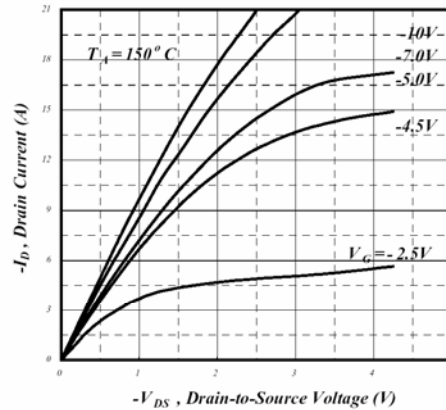

Fig 2. Typical Output Characteristics

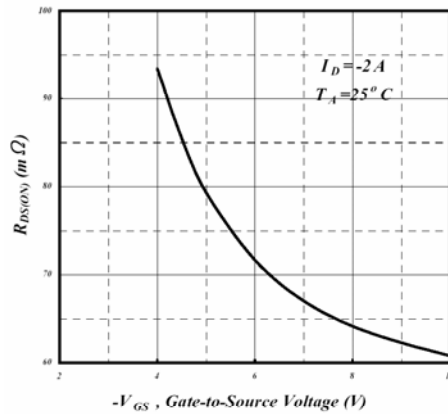

Fig 3. On-Resistance v.s. Gate Voltage

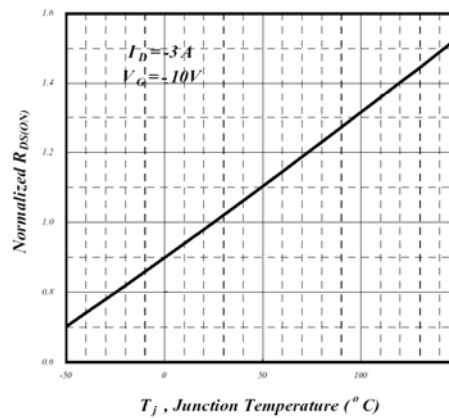

Fig 4. Normalized On-Resistance v.s. Junction Temperature

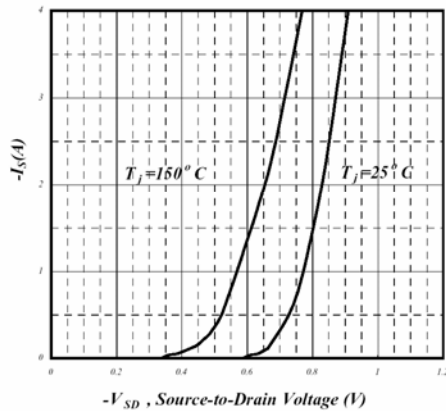

Fig 5. Forward Characteristic of Reverse Diode

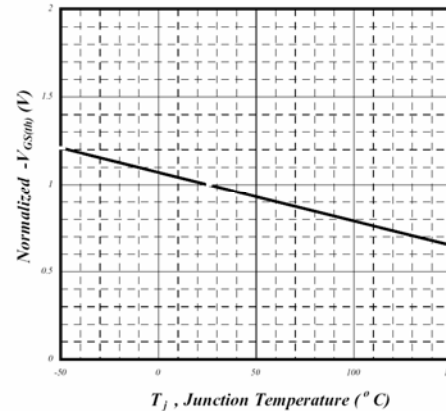

Fig 6. Gate Threshold Voltage v.s. Junction Temperature

2N and 2P-Channel Enhancement Mode Power MOSFET

■ Typical Performance Characteristics (P-Channel) (Continued)

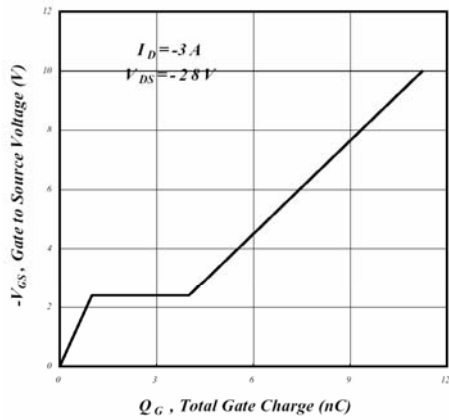

Fig 7. Gate Charge Characteristics

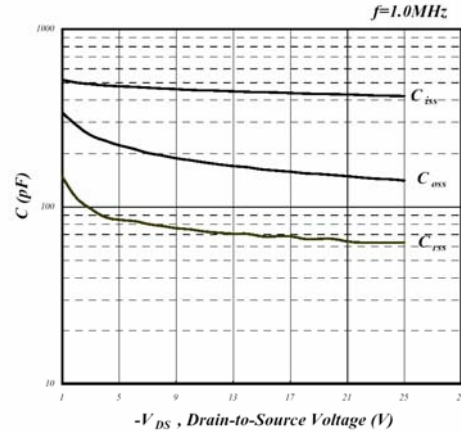

Fig 8. Typical Capacitance Characteristics

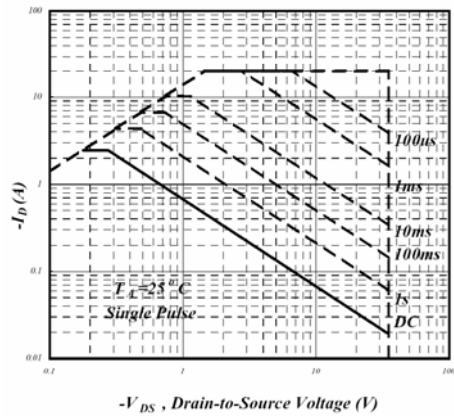

Fig 9. Maximum Safe Operating Area

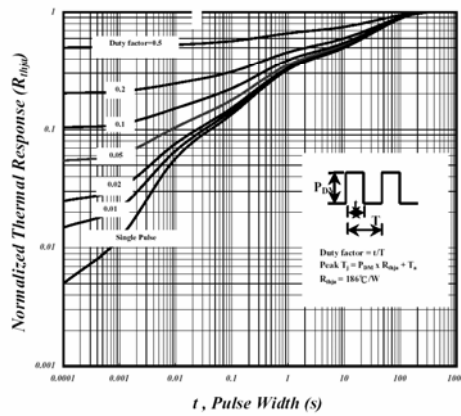

Fig 10. Effective Transient Thermal Impedance

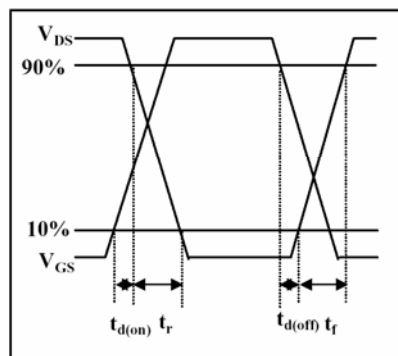

Fig 11. Switching Time Waveform

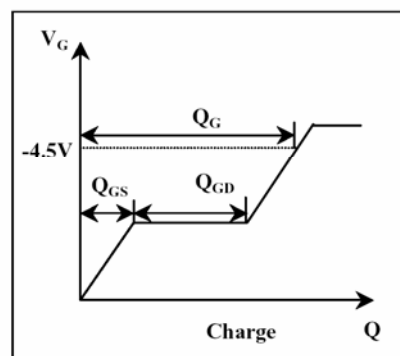
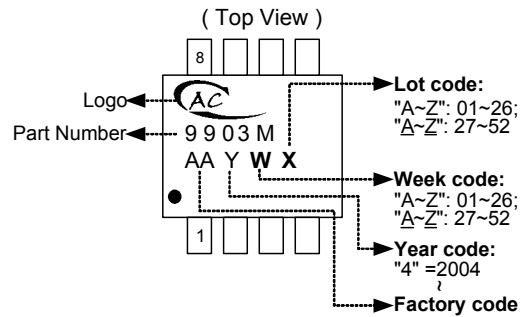

Fig 12. Gate Charge Waveform

2N and 2P-Channel Enhancement Mode Power MOSFET

■ Marking Information

SO-8L



■ Package Information

Package Type: SO-8L

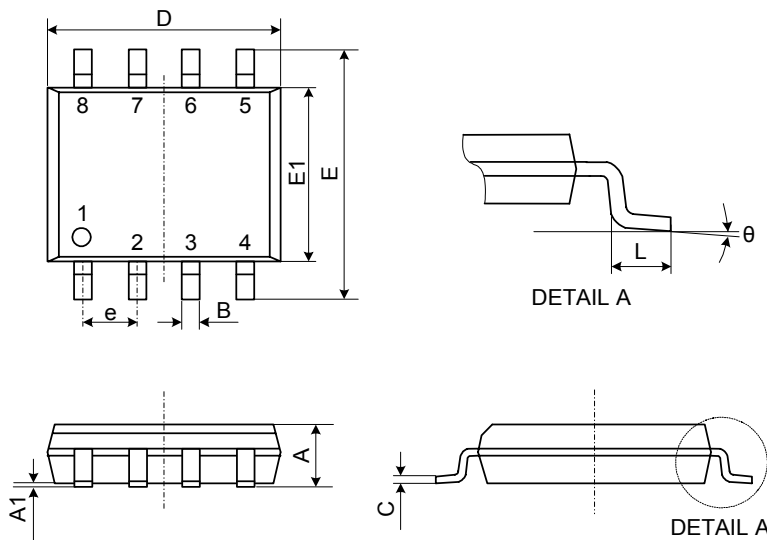

1. All Dimensions Are in Millimeters.
2. Dimension Does Not Include Mold Protrusions.

Symbol	Dimensions In Millimeters		
	Min.	Nom.	Max.
A	1.35	1.55	1.75
A1	0.10	0.18	0.25
B	0.33	0.41	0.51
C	0.19	0.22	0.25
D	4.80	4.90	5.00
E	5.80	6.15	6.50
E1	3.80	3.90	4.00
L	0.38	0.71	1.27
θ	0°	4°	8°
e	1.27 TYP.		