

TOSHIBA MOS DIGITAL INTEGRATED CIRCUIT SILICON GATE CMOS

262,144-WORD BY 16-BIT STATIC RAM

**DESCRIPTION**

The TC554161AFT is a 4,194,304-bit static random access memory (SRAM) organized as 262,144 words by 16bits. Fabricated using Toshiba's CMOS Silicon gate process technology, this device operates from a single 5V ± 10% power supply. Advanced circuit technology provides both high speed and low power at an operating current of 10 mA/MHz (typ) and a minimum cycle time of 70 ns. It is automatically placed in low-power mode at 2 μA standby current (typ) when chip enable ( $\overline{CE}$ ) is asserted high. There are two control inputs.  $\overline{CE}$  is used to select the device and for data retention control, and output enable ( $\overline{OE}$ ) provides fast memory access. Data byte control pin ( $\overline{LB}$ ,  $\overline{UB}$ ) provides lower and upper byte access. This device is well suited to various microprocessor system applications where high speed, low power and battery backup are required. The TC554161AFT is available in a plastic 54-pin thin-small-outline package (TSOP).

**FEATURES**

- Low-power dissipation  
Operating: 55 mW/MHz (typical)
- Single power supply voltage of 5 V ± 10%
- Power down features using  $\overline{CE}$ .
- Data retention supply voltage of 2 to 5.5 V
- Direct TTL compatibility for all inputs and outputs
- Standby Current (maximum):

	TC554161AFT	
	-70,-85,-10	-70L,-85L,-10L
5.5 V	100 μA	50 μA
3.0 V	50 μA	25 μA

- Access Times (maximum):

	TC554161AFT		
	-70,-70L	-85,-85L	-10,-10L
Access Time	70 ns	85 ns	100 ns
$\overline{CE}$ Access Time	70 ns	85 ns	100 ns
$\overline{OE}$ Access Time	35 ns	45 ns	50 ns

- Package:  
TSOP II54-P-400-0.80 (AFT) (Weight: 0.57 g typ)

**PIN ASSIGNMENT (TOP VIEW)**

NC □ 1 ○	54 □ A4
A3 □ 2	53 □ A5
A2 □ 3	52 □ A6
A1 □ 4	51 □ A7
A0 □ 5	50 □ NC
I/O16 □ 6	49 □ I/O1
I/O15 □ 7	48 □ I/O2
V <sub>DD</sub> □ 8	47 □ V <sub>DD</sub>
GND □ 9	46 □ GND
I/O14 □ 10	45 □ I/O3
I/O13 □ 11	44 □ I/O4
$\overline{UB}$ □ 12	43 □ $\overline{LB}$
$\overline{CE}$ □ 13	42 □ $\overline{OE}$
OP □ 14	41 □ OP
R/W □ 15	40 □ NC
I/O12 □ 16	39 □ I/O5
I/O11 □ 17	38 □ I/O6
GND □ 18	37 □ GND
V <sub>DD</sub> □ 19	36 □ V <sub>DD</sub>
I/O10 □ 20	35 □ I/O7
I/O9 □ 21	34 □ I/O8
NC □ 22	33 □ A8
A17 □ 23	32 □ A9
A16 □ 24	31 □ A10
A15 □ 25	30 □ A11
A14 □ 26	29 □ A12
A13 □ 27	28 □ NC

(Normal pinout)

**PIN NAMES**

A0~A17	Address Inputs
I/O1~I/O16	Data Inputs/Outputs
$\overline{CE}$	Chip Enable
R/W	Read/Write Control
$\overline{OE}$	Output Enable
$\overline{LB}$ , $\overline{UB}$	Data Byte Control
V <sub>DD</sub>	Power (+5 V)
GND	Ground
NC	No Connection
OP*	Option

\*: OP pin must be open or connected to GND.



## BLOCK DIAGRAM

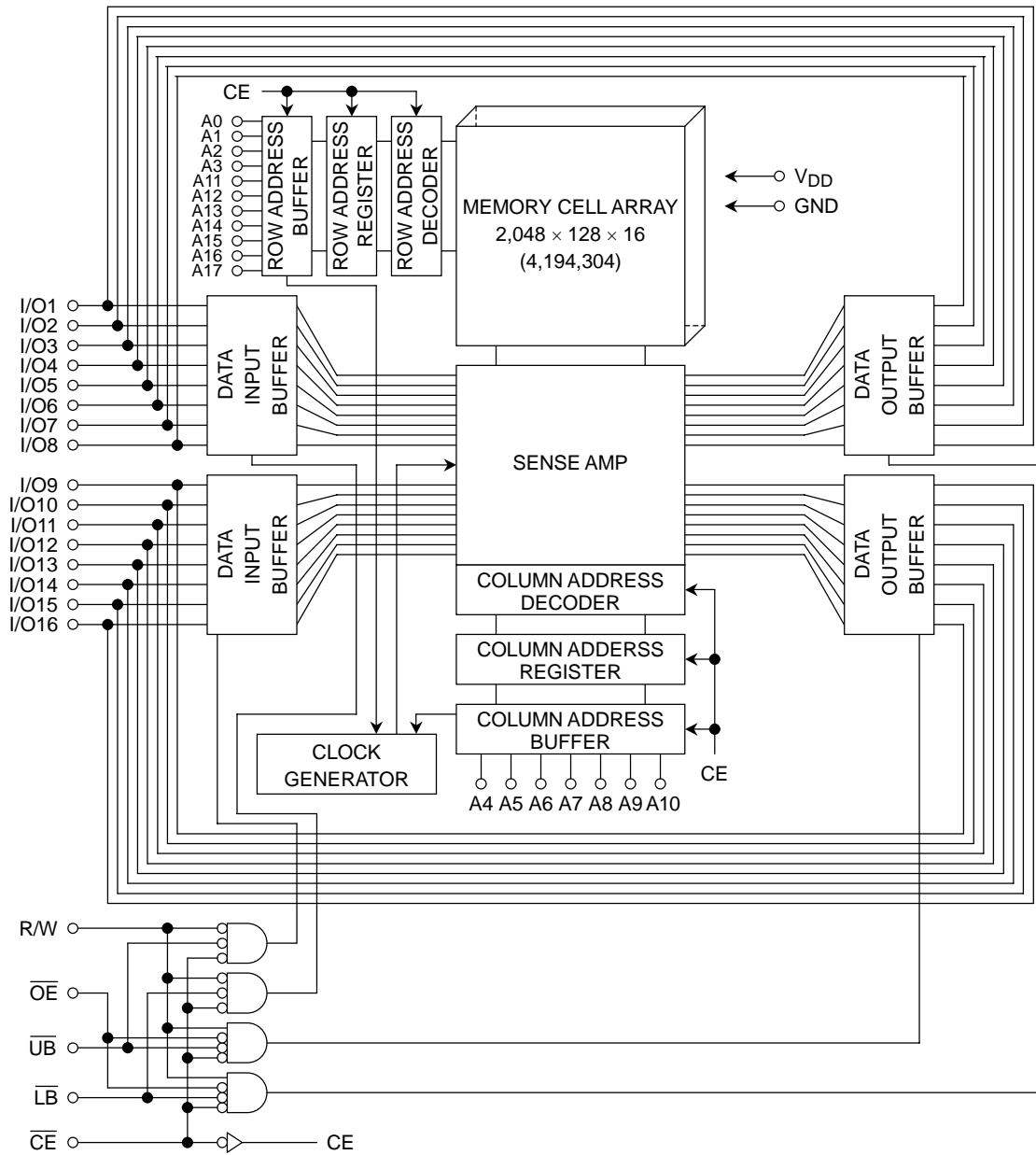

## MAXIMUM RATINGS

SYMBOL	RATING	VALUE	UNIT
$V_{DD}$	Power Supply Voltage	-0.3~7.0	V
$V_{IN}$	Input Voltage	-0.3*~7.0	V
$V_{I/O}$	Input/Output Voltage	-0.5~ $V_{DD} + 0.5$	V
$P_D$	Power Dissipation	0.6	W
$T_{solder}$	Soldering Temperature (10s)	260	°C
$T_{stg}$	Storage Temperature	-55~150	°C
$T_{opr}$	Operating Temperature	0~70	°C

\*: -3.0 V when measured at a pulse width of 30ns

## DC RECOMMENDED OPERATING CONDITIONS (Ta = 0° to 70°C)

SYMBOL	PARAMETER	MIN	TYP	MAX	UNIT
V <sub>DD</sub>	Power Supply Voltage	4.5	5.0	5.5	V
V <sub>IH</sub>	Input High Voltage	2.2	—	V <sub>DD</sub> + 0.3	V
V <sub>IL</sub>	Input Low Voltage	-0.3*	—	0.8	V
V <sub>DH</sub>	Data Retention Supply Voltage	2.0	—	5.5	V

\*: -3.0 V when measured at a pulse width of 30 ns

## DC CHARACTERISTICS (Ta = 0° to 70°C, V<sub>DD</sub> = 5 V ± 10%)

SYMBOL	PARAMETER	TEST CONDITION		MIN	TYP	MAX	UNIT	
I <sub>IL</sub>	Input Leakage Current	V <sub>IN</sub> = 0 V~V <sub>DD</sub>		—	—	±1.0	μA	
I <sub>LO</sub>	Output Leakage Current	$\overline{CE} = V_{IH}$ or R/W = V <sub>IL</sub> or $\overline{OE} = V_{IH}$ , V <sub>OUT</sub> = 0 V~V <sub>DD</sub>		—	—	±1.0	μA	
I <sub>OH</sub>	Output High Current	V <sub>OH</sub> = 2.4 V		-1.0	—	—	mA	
I <sub>OL</sub>	Output Low Current	V <sub>OL</sub> = 0.4 V		2.1	—	—	mA	
I <sub>DDO1</sub>	Operating Current	$\overline{CE} = V_{IL}$ and R/W = V <sub>IH</sub> , I <sub>OUT</sub> = 0 mA, Other Input = V <sub>IH</sub> /V <sub>IL</sub>	t <sub>cycle</sub> = 70 ns	—	—	110	mA	
			t <sub>cycle</sub> = 85 ns, 100 ns	—	—	100		
			t <sub>cycle</sub> = 1 μs	—	15	—		
I <sub>DDO2</sub>	Operating Current	$\overline{CE} = 0.2$ V and R/W = V <sub>DD</sub> - 0.2 V, I <sub>OUT</sub> = 0 mA, Other Input = V <sub>DD</sub> - 0.2 V/0.2 V	t <sub>cycle</sub> = 70 ns	—	—	100	mA	
			t <sub>cycle</sub> = 85 ns, 100 ns	—	—	90		
			t <sub>cycle</sub> = 1 μs	—	10	—		
I <sub>DDS1</sub>	Standby Current	$\overline{CE} = V_{IH}$		—	—	3	mA	
I <sub>DDS2</sub>		$\overline{CE} = V_{DD} - 0.2$ V, V <sub>DD</sub> = 2.0 V~5.5 V	-70,-85,-10	Ta = 25°C	—	2		—
				Ta = 0~70°C	—	—		100
			-70L,-85L,-10L	Ta = 25°C	—	2		5
	Ta = 0~70°C			—	—	50		

## CAPACITANCE (Ta = 25°C, f = 1 MHz)

SYMBOL	PARAMETER	TEST CONDITION	MAX	UNIT
C <sub>IN</sub>	Input Capacitance	V <sub>IN</sub> = GND	10	pF
C <sub>OUT</sub>	Output Capacitance	V <sub>OUT</sub> = GND	10	pF

Note: This parameter is periodically sampled and is not 100% tested.

## OPERATING MODE

MODE	$\overline{CE}$	$\overline{OE}$	R/W	$\overline{LB}$	$\overline{UB}$	I/O1~I/O8	I/O9~I/O16	POWER
Read	L	L	H	L	L	Output	Output	I <sub>DDO</sub>
				H	L	High-Z	Output	I <sub>DDO</sub>
				L	H	Output	High-Z	I <sub>DDO</sub>
Write	L	*	L	L	L	Input	Input	I <sub>DDO</sub>
				H	L	High-Z	Input	I <sub>DDO</sub>
				L	H	Input	High-Z	I <sub>DDO</sub>
Output Deselect	L	H	H	*	*	High-Z	High-Z	I <sub>DDO</sub>
	L	*	*	H	H			
Standby	H	*	*	*	*	High-Z	High-Z	I <sub>DDS</sub>

\* = don't care

H = logic high

L = logic low

## AC CHARACTERISTICS AND OPERATING CONDITIONS (Ta = 0° to 70°C, VDD = 5 V ± 10%)

### READ CYCLE

SYMBOL	PARAMETER	TC554161AFT						UNIT
		-70,-70L		-85,-85L		-10,-10L		
		MIN	MAX	MIN	MAX	MIN	MAX	
t <sub>RC</sub>	Read Cycle Time	70	—	85	—	100	—	ns
t <sub>ACC</sub>	Address Access Time	—	70	—	85	—	100	
t <sub>CO</sub>	Chip Enable Access Time	—	70	—	85	—	100	
t <sub>OE</sub>	Output Enable Access Time	—	35	—	45	—	50	
t <sub>BA</sub>	Data Byte Control Access Time	—	35	—	45	—	50	
t <sub>OH</sub>	Output Data Hold Time	10	—	10	—	10	—	
t <sub>COE</sub>	Chip Enable Low to Output Active	10	—	10	—	10	—	
t <sub>OEE</sub>	Output Enable Low to Output Active	5	—	5	—	5	—	
t <sub>BE</sub>	Data Byte Control Low to Output Active	5	—	5	—	5	—	
t <sub>OD</sub>	Chip Enable High to Output High-Z	—	25	—	30	—	35	
t <sub>ODO</sub>	Output Enable High to Output High-Z	—	25	—	30	—	35	
t <sub>BD</sub>	Data Byte Control High to Output High-Z	—	25	—	30	—	35	

### WRITE CYCLE

SYMBOL	PARAMETER	TC554161AFT						UNIT
		-70,-70L		-85,-85L		-10,-10L		
		MIN	MAX	MIN	MAX	MIN	MAX	
t <sub>WC</sub>	Write Cycle Time	70	—	85	—	100	—	ns
t <sub>WP</sub>	Write Pulse Width	50	—	55	—	60	—	
t <sub>CW</sub>	Chip Enable to End of Write	60	—	70	—	80	—	
t <sub>BW</sub>	Data Byte Control to End of Write	50	—	55	—	60	—	
t <sub>AS</sub>	Address Setup Time	0	—	0	—	0	—	
t <sub>WR</sub>	Write Recovery Time	0	—	0	—	0	—	
t <sub>DS</sub>	Data Setup Time	30	—	35	—	40	—	
t <sub>DH</sub>	Data Hold Time	0	—	0	—	0	—	
t <sub>OEW</sub>	R/W High to Output Active	5	—	5	—	5	—	
t <sub>ODW</sub>	R/W Low to Output High-Z	—	25	—	30	—	35	

### AC TEST CONDITIONS

PARAMETER	TEST CONDITION
Output load	100 pF + 1 TTL Gate
Input pulse level	0.6 V, 2.4 V
Timing measurements	1.5 V
Reference level	1.5 V
t <sub>R</sub> , t <sub>F</sub>	5 ns

## TIMING DIAGRAMS

### READ CYCLE (See Note 1)

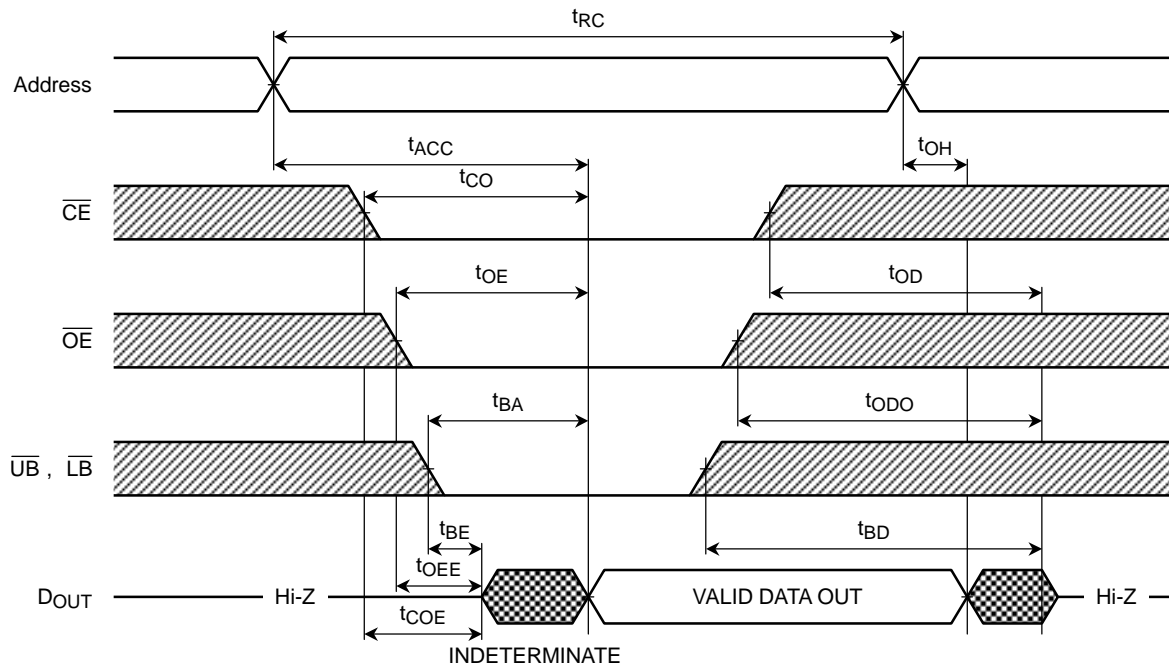

### WRITE CYCLE 1 (R/W CONTROLLED) (See Note 4)

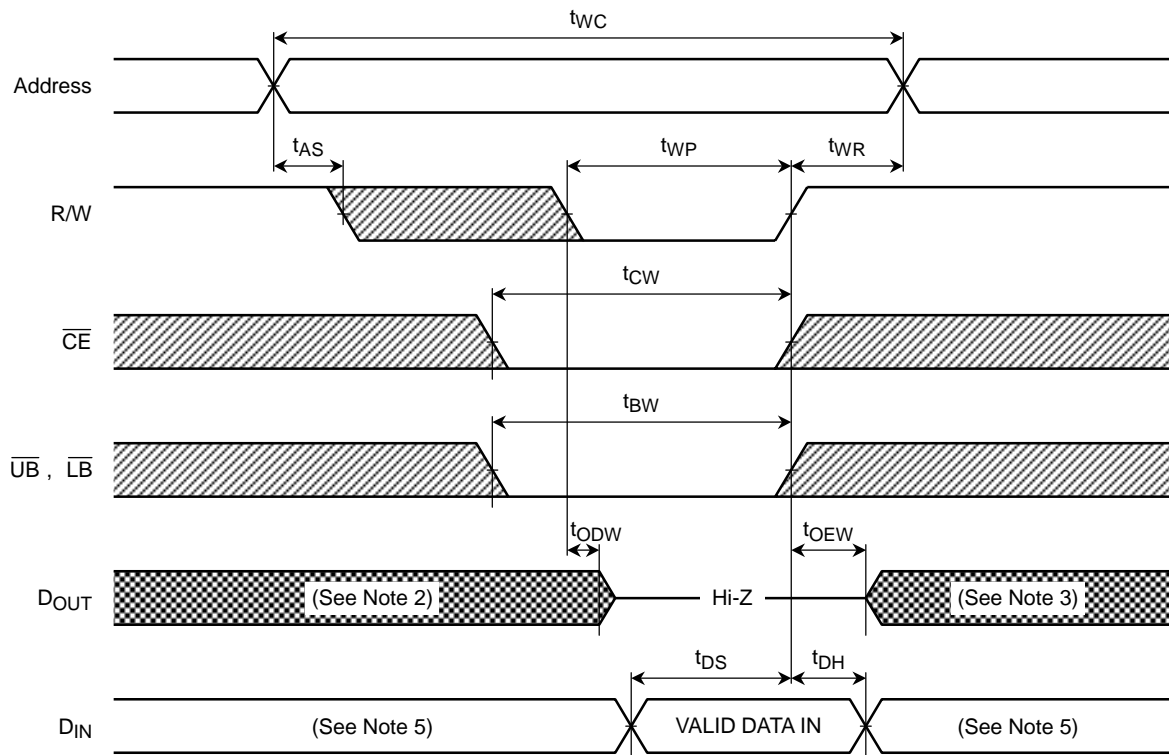

WRITE CYCLE 2 ( $\overline{CE}$  CONTROLLED) (See Note 4)

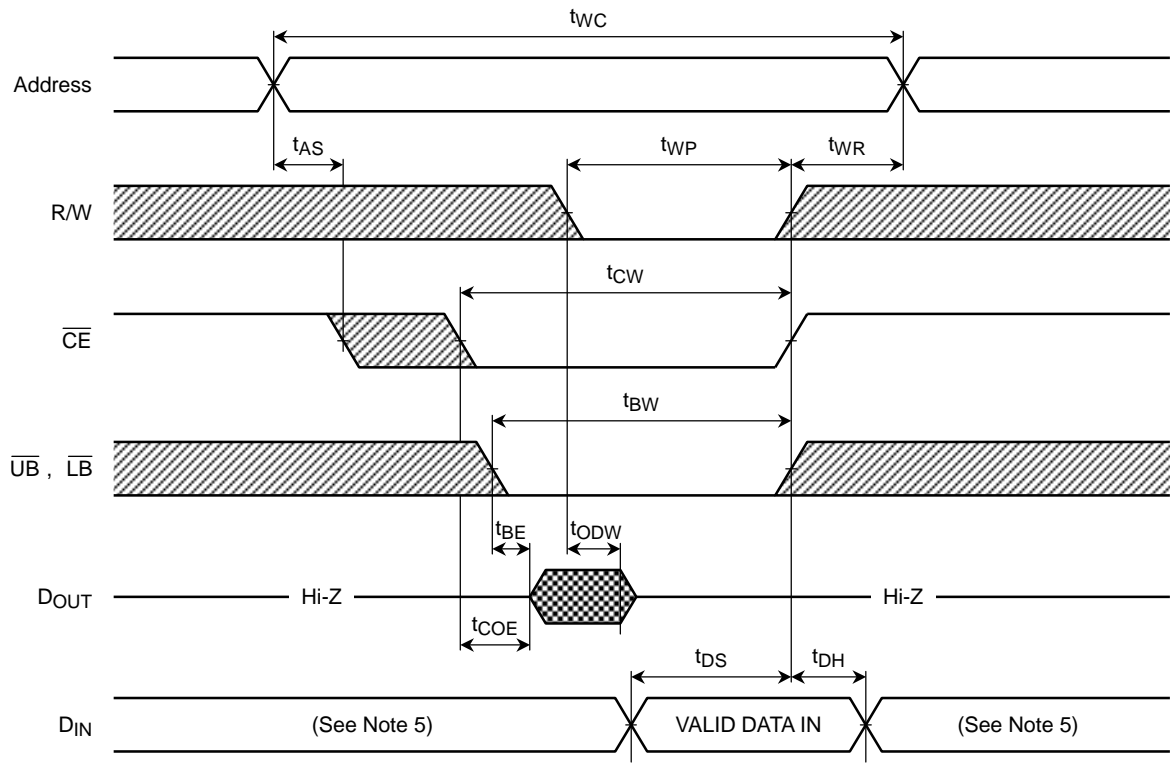

WRITE CYCLE 3 ( $\overline{UB}$   $\overline{LB}$  CONTROLLED) (See Note 4)

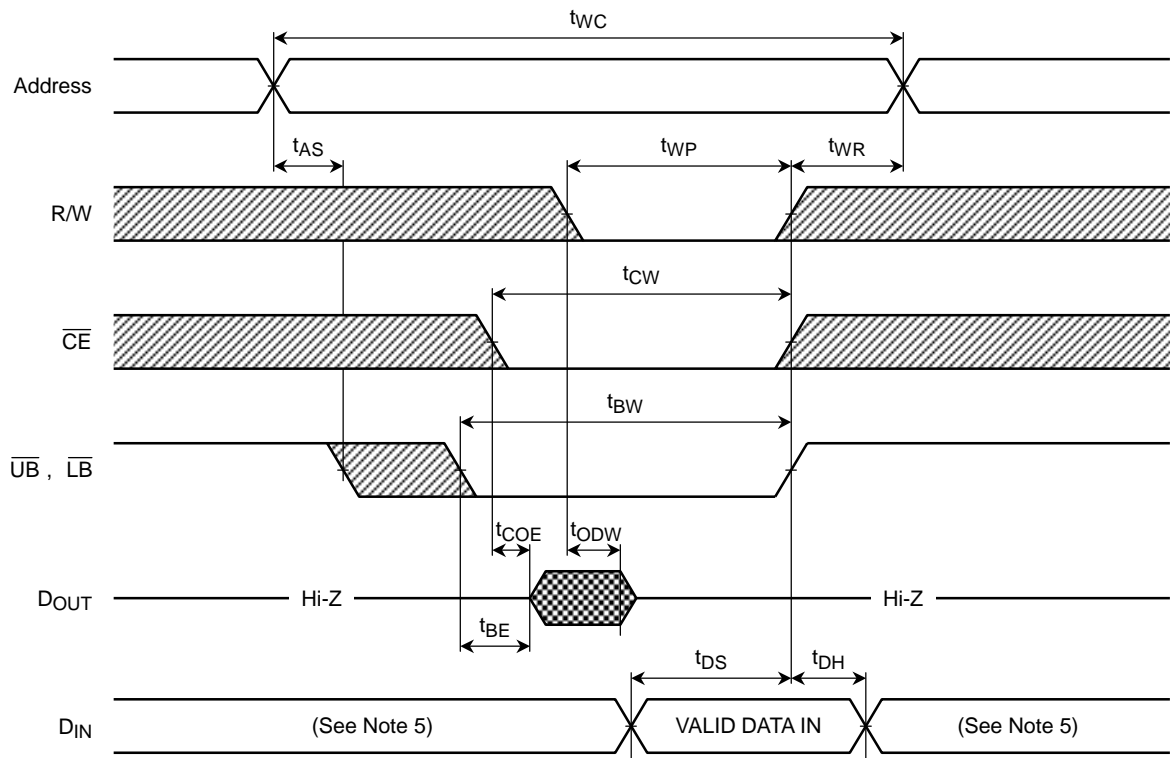

Note:

- (1) R/W remains HIGH for the read cycle.
- (2) If  $\overline{CE}$  goes LOW coincident with or after R/W goes LOW, the outputs will remain at high impedance.
- (3) If  $\overline{CE}$  goes HIGH coincident with or before R/W goes HIGH, the outputs will remain at high impedance.
- (4) If  $\overline{OE}$  is HIGH during the write cycle, the outputs will remain at high impedance.
- (5) Because I/O signals may be in the output state at this time, input signals of reverse polarity must not be applied.

## DATA RETENTION CHARACTERISTICS (Ta = 0° to 70°C)

SYMBOL	PARAMETER		MIN	TYP	MAX	UNIT	
V <sub>DH</sub>	Data Retention Supply Voltage		2.0	—	5.5	V	
I <sub>DDs2</sub>	Standby Current	-70,-85,-10	V <sub>DH</sub> = 3.0 V	—	—	50	μA
			V <sub>DH</sub> = 5.5 V	—	—	100	
		-70L,-85L,-10L	V <sub>DH</sub> = 3.0 V	—	—	25*	
			V <sub>DH</sub> = 5.5 V	—	—	50	
t <sub>CDR</sub>	Chip Deselect to Data Retention Mode Time		0	—	—	ns	
t <sub>R</sub>	Recovery Time		5	—	—	ms	

\*: 5 μA (max) at Ta = 0° to 40°C

## $\overline{CE}$ CONTROLLED DATA RETENTION MODE

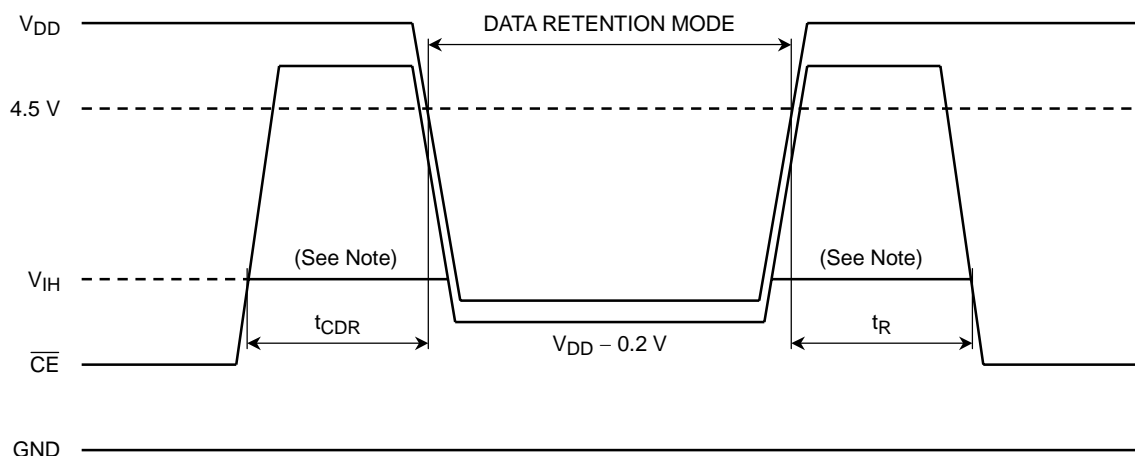

Note: When  $\overline{CE}$  is operating at the V<sub>IH</sub> level (2.2V), the standby current is given by I<sub>DDs1</sub> during the transition of V<sub>DD</sub> from 4.5 to 2.4V.



**PACKAGE DIMENSIONS**

TSOPII54-P-400-0.80

Unit: mm

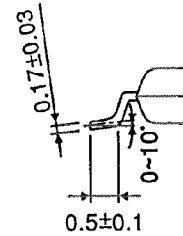
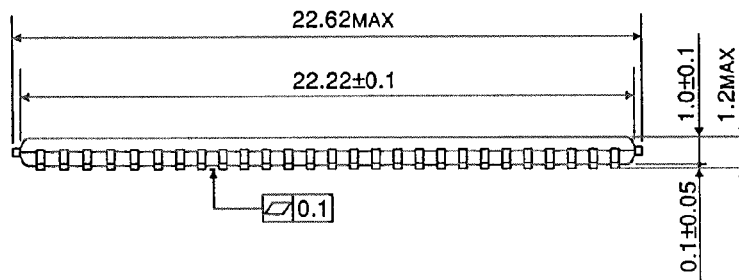
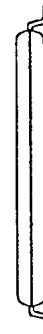
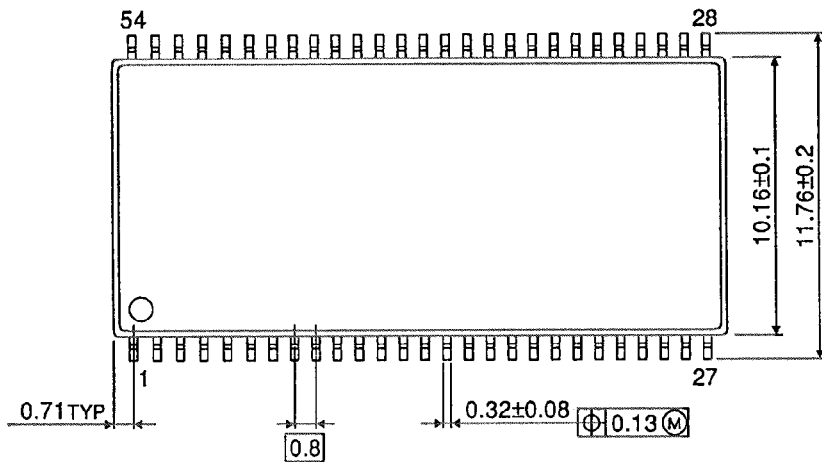

Weight: 0.57 g (typ)

**RESTRICTIONS ON PRODUCT USE**

000707EBA

- TOSHIBA is continually working to improve the quality and reliability of its products. Nevertheless, semiconductor devices in general can malfunction or fail due to their inherent electrical sensitivity and vulnerability to physical stress. It is the responsibility of the buyer, when utilizing TOSHIBA products, to comply with the standards of safety in making a safe design for the entire system, and to avoid situations in which a malfunction or failure of such TOSHIBA products could cause loss of human life, bodily injury or damage to property.  
In developing your designs, please ensure that TOSHIBA products are used within specified operating ranges as set forth in the most recent TOSHIBA products specifications. Also, please keep in mind the precautions and conditions set forth in the "Handling Guide for Semiconductor Devices," or "TOSHIBA Semiconductor Reliability Handbook" etc..
- The TOSHIBA products listed in this document are intended for usage in general electronics applications (computer, personal equipment, office equipment, measuring equipment, industrial robotics, domestic appliances, etc.). These TOSHIBA products are neither intended nor warranted for usage in equipment that requires extraordinarily high quality and/or reliability or a malfunction or failure of which may cause loss of human life or bodily injury ("Unintended Usage"). Unintended Usage include atomic energy control instruments, airplane or spaceship instruments, transportation instruments, traffic signal instruments, combustion control instruments, medical instruments, all types of safety devices, etc.. Unintended Usage of TOSHIBA products listed in this document shall be made at the customer's own risk.
- The products described in this document are subject to the foreign exchange and foreign trade laws.
- The information contained herein is presented only as a guide for the applications of our products. No responsibility is assumed by TOSHIBA CORPORATION for any infringements of intellectual property or other rights of the third parties which may result from its use. No license is granted by implication or otherwise under any intellectual property or other rights of TOSHIBA CORPORATION or others.
- The information contained herein is subject to change without notice.