



AIC1521

Single High-Side Power Switch With Control Function

FEATURES

- 120mΩ (5V Input) High-Side MOSFET Switch.
- 500mA Continuous Load Current.
- 80μA Typical On-State Supply Current.
- 1μA Typical Off-State Supply Current.
- Current-Limit / Short Circuit Protection.
- Thermal Limiting Protection under Overcurrent Condition.
- Undervoltage Lockout Ensures that Switch is off at Start Up.
- Output can be Forced Higher than Input (Off-State).
- Slow Turn ON and Fast Turn OFF.
- Active-High or Active-Low Enable.

APPLICATIONS

- Motherboard USB Management.
- USB Power Management.
- Hot Plug-In Power Supplies.
- Battery-Charger Circuit.
- Power Distribution Switch.

TYPICAL APPLICATION CIRCUIT

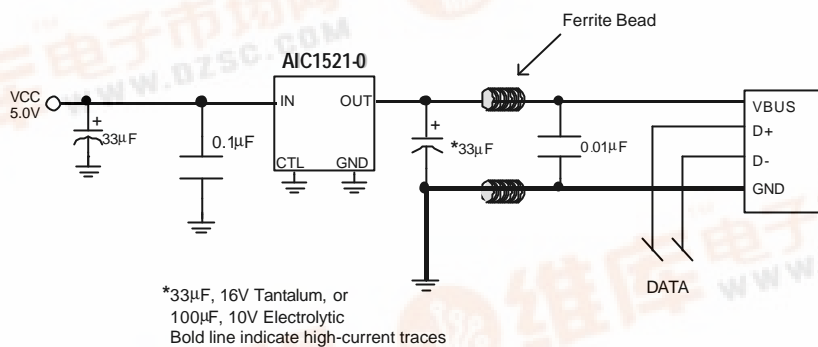

USB High-Side Power Switch

DESCRIPTION

The AIC1521 is an integrated high-side power switch for self-powered and bus-powered Universal Serial Bus (USB) applications. The high-side switch is a MOSFET with 120mΩ $R_{DS(ON)}$, which meets USB voltage drop requirements for maximum transmission wire length. The switch ON/OFF is controlled by CTL pin.

Output current is typically limited to 1.0A, well below the 5A safety requirement, and thermal shutdown function shuts the switch off to prevent damage under overcurrent conditions.

Guaranteed minimum output rise time limits inrush current during hot plug-in, minimizing EMI and preventing the voltage at upstream port from dropping excessively.



ORDERING INFORMATION

AIC1521-XCX

PACKAGING TYPE
 O: MSOP
 S: SO8
 W: SOT-89-5

CONTROL POLARITY
 0: Active Low
 1: Active High

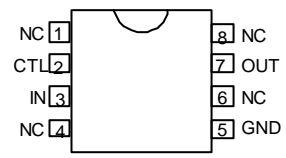
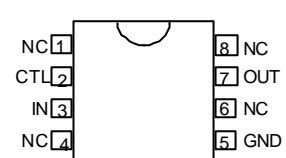
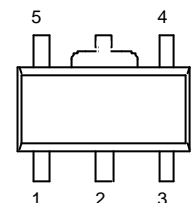
ORDER NUMBER	PIN CONFIGURATION
AIC1521-0CO AIC1521-1CO (MSOP8)	FRONT VIEW 
AIC1521-0CS AIC1521-1CS (SO8)	FRONT VIEW 
AIC1521-0CW AIC1521-1CW (SOT-89-5)	FRONT VIEW 1: IN 2: GND 3: OUT 4: NC 5: CTL 

ABSOLUTE MAXIMUM RATINGS

Supply Voltage (V_{IN}) 7.0V
 Operating Temperature Range -40°C ~ 85°C
 Storage Temperature Range -65°C ~ 150°C

ELECTRICAL CHARACTERISTICS ($V_{IN}=5V$, $T_a=25^\circ C$, unless otherwise specified.)

PARAMETERS	CONDITIONS	MIN.	TYP.	MAX.	UNIT
Supply Current	Switch Off, OUT=Open		0.75	2	μA
	Switch On, OUT=Open		80	100	
Control Input Voltage	$V_{CTL} = \text{Logic "0"}$			0.8	V
	$V_{CTL} = \text{Logic "1"}$	2.4			
Control Input Current	$V_{CTL} = \text{Logic "0"}$		0.01	1	μA
	$V_{CTL} = \text{Logic "1"}$		0.01	1	
Output MOSFET Resistance	$I_{OUT} = 500mA$		120	180	$m\Omega$
Output Turn-On Rise Delay	$R_L = 10\Omega$		30		μS
Output Turn-On Rise Time	$R_L = 10\Omega$		500		μS
Output Turn-Off Delay	$R_L = 10\Omega$		0.2	10	μS

ELECTRICAL CHARACTERISTICS (Continued)

PARAMETERS	CONDITIONS	MIN.	TYP.	MAX.	UNIT
Output Turn-Off Fall Time	$R_L = 10\Omega$		0.2	10	μS
Output Leakage Current				2	μA
Current Limit Threshold		0.6	1.0	1.25	A
Thermal Limit			110		$^{\circ}\text{C}$
UVLO Threshold	V_{IN} Increasing V_{IN} Decreasing		2.8 2.6		V

BLOCK DIAGRAM

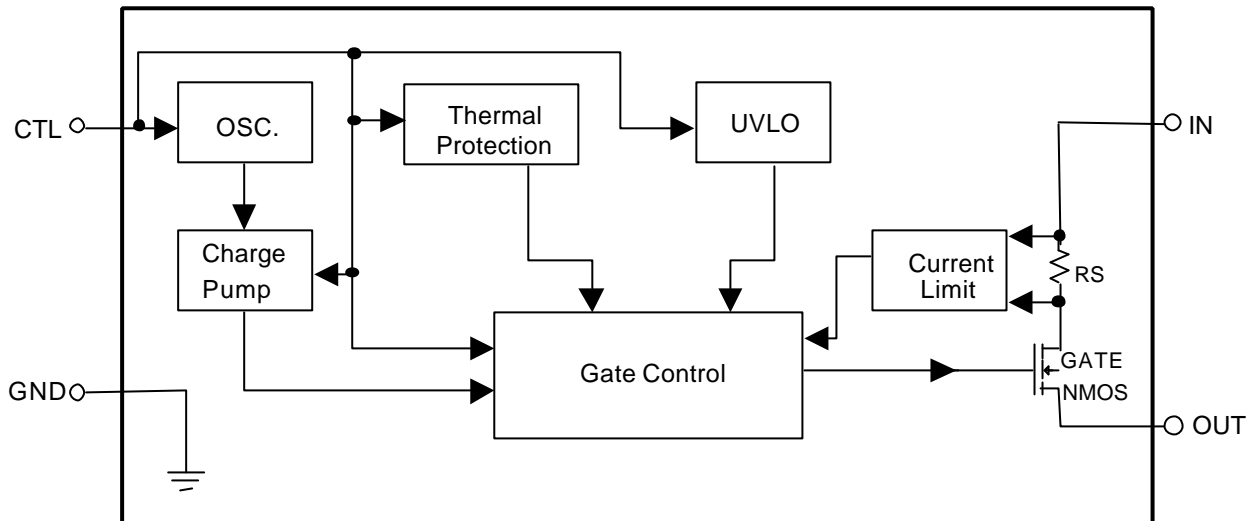

TYPICAL PERFORMANCE CHARACTERISTICS

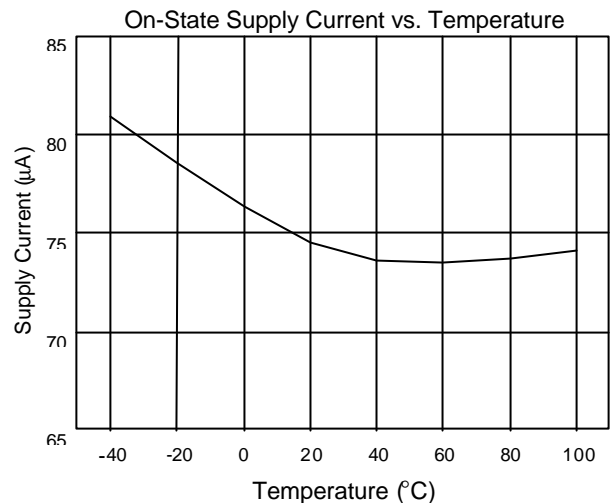
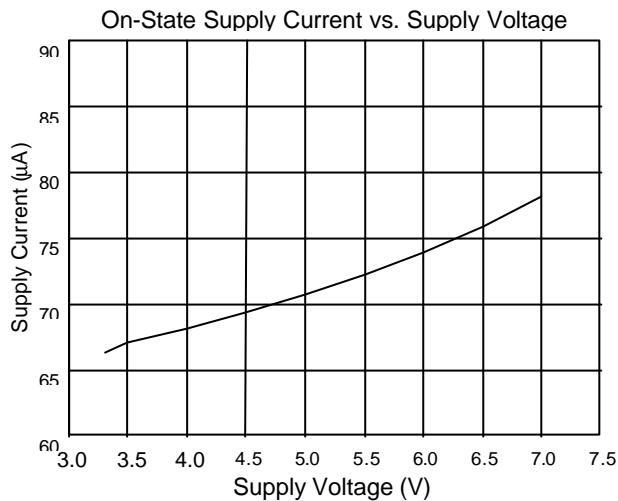

TYPICAL PERFORMANCE CHARACTERISTICS (Continued)

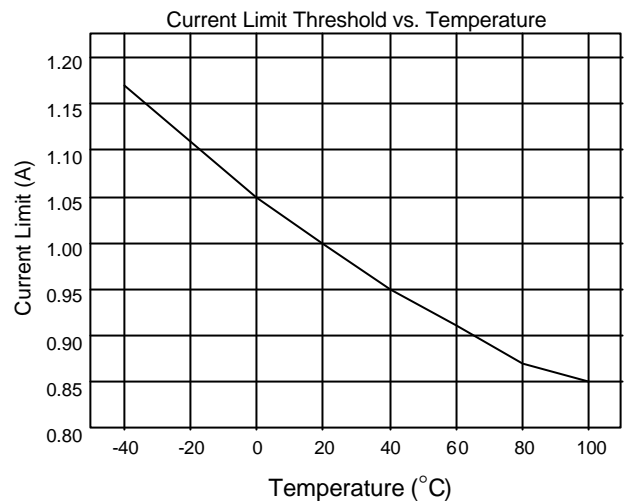
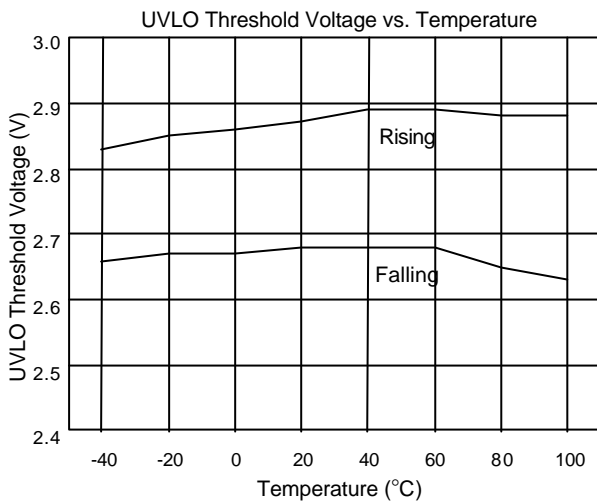
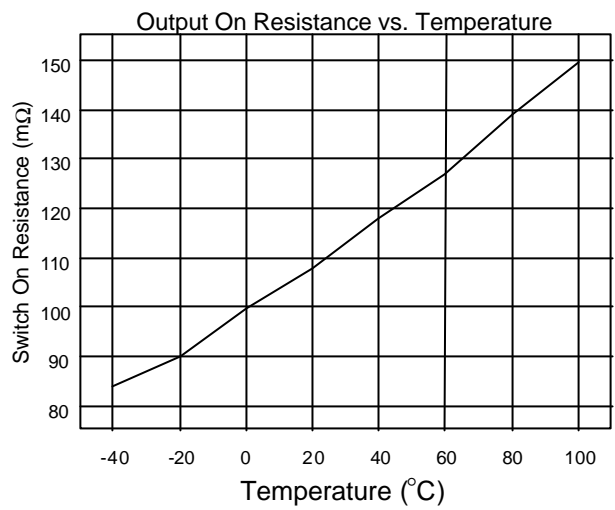
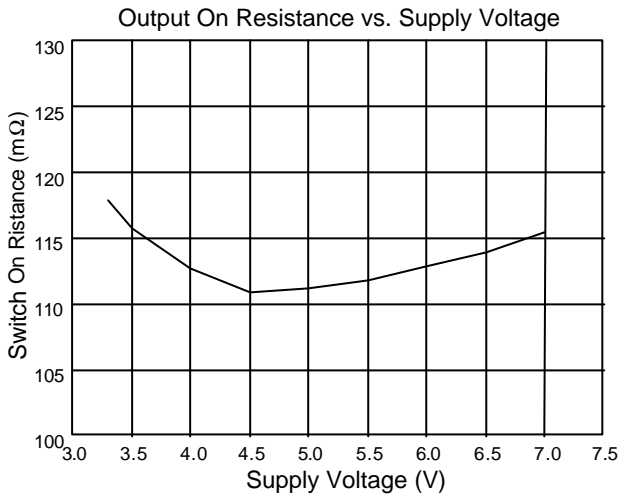
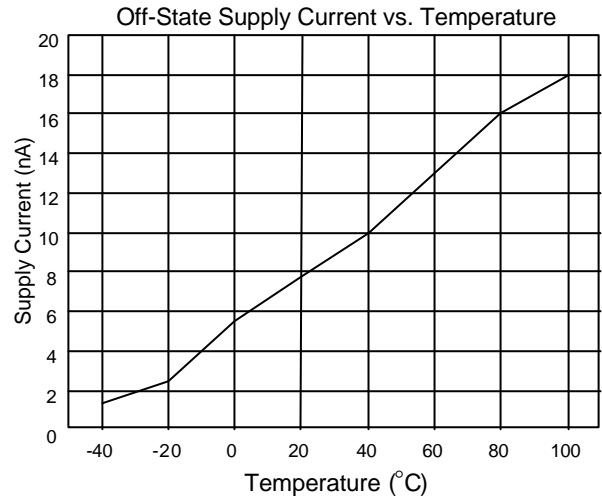
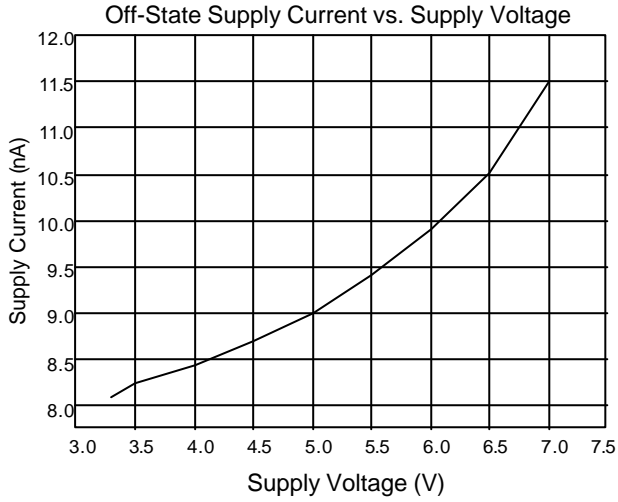

TYPICAL PERFORMANCE CHARACTERISTICS (Continued)

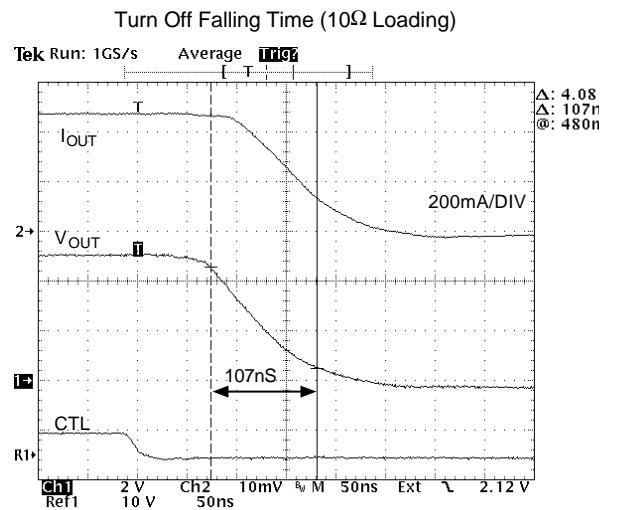
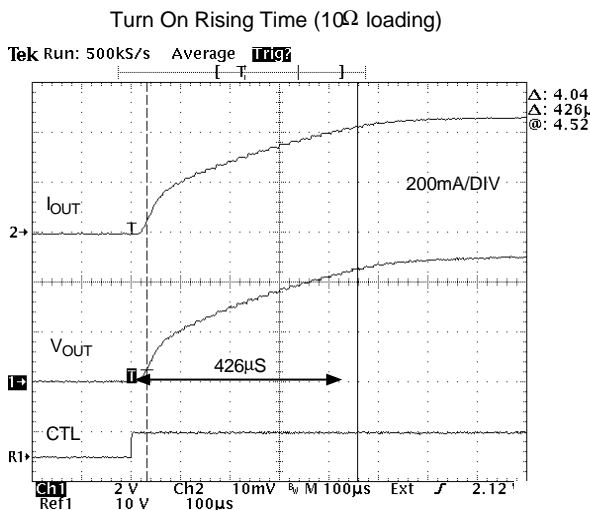
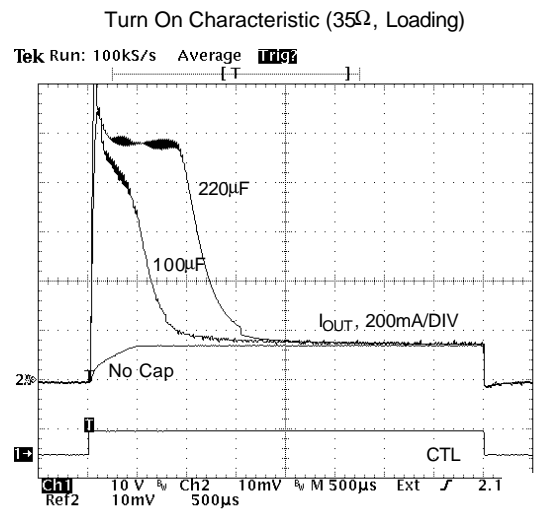
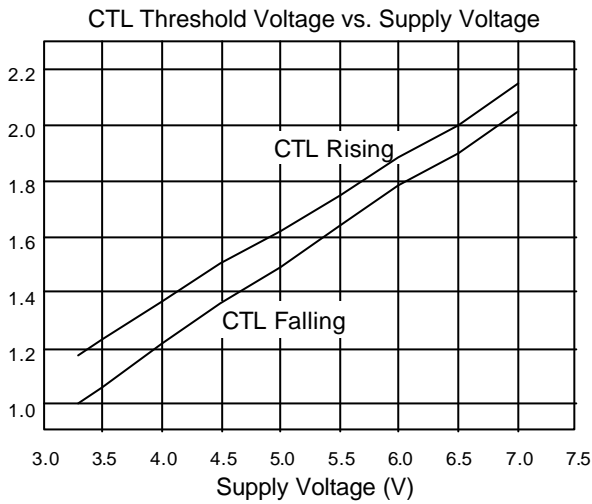
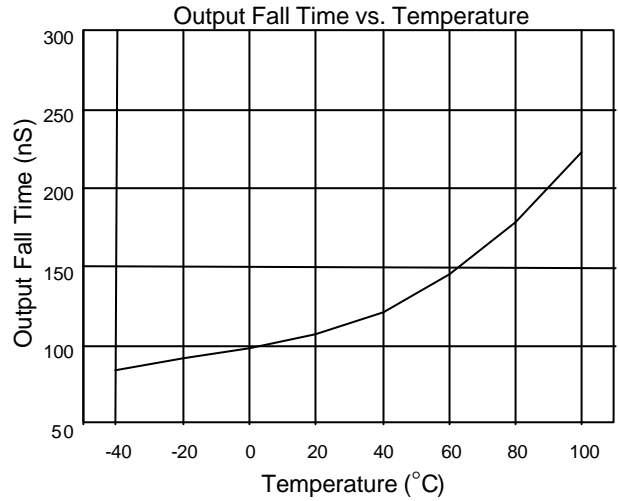
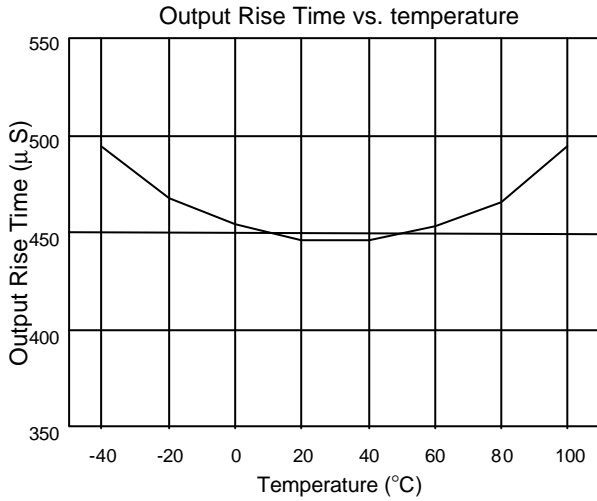

TYPICAL PERFORMANCE CHARACTERISTICS (Continued)

Turn On Characteristic (35Ω, 100μF Loading)

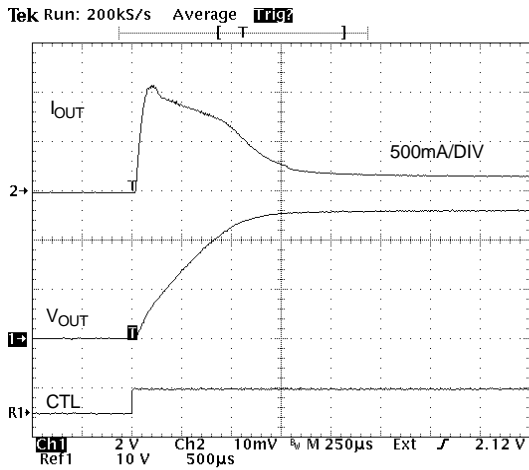

Turn Off Falling Time (35Ω, 100uF Loading)

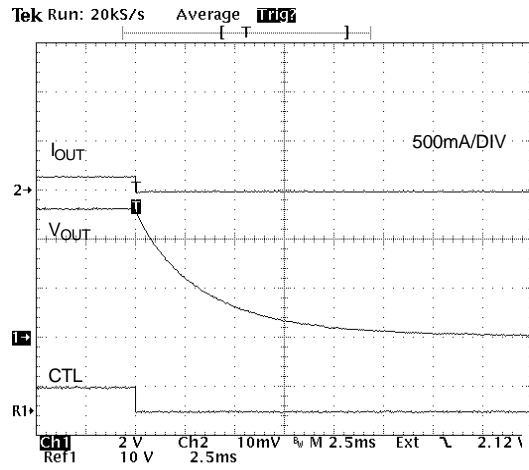

Current Limit Threshold

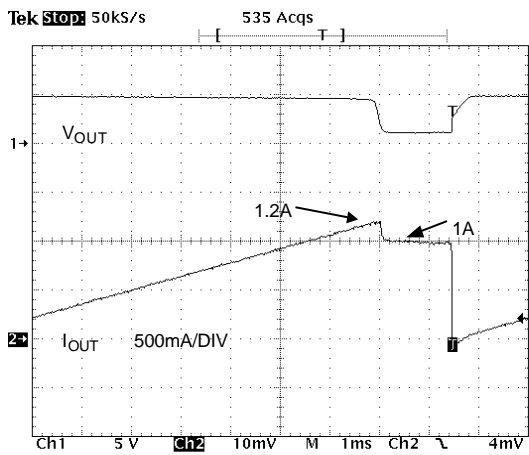

Thermal Limiting Transient Response

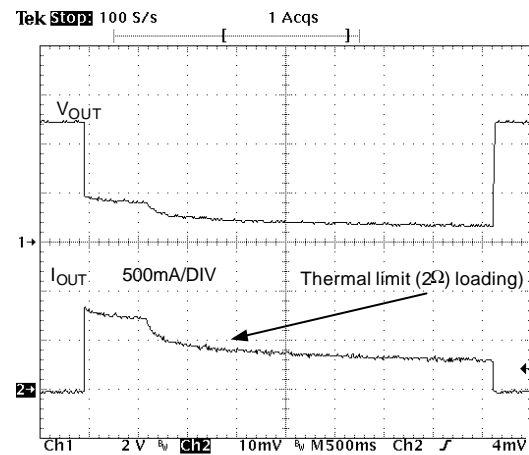

Short Circuit Testing

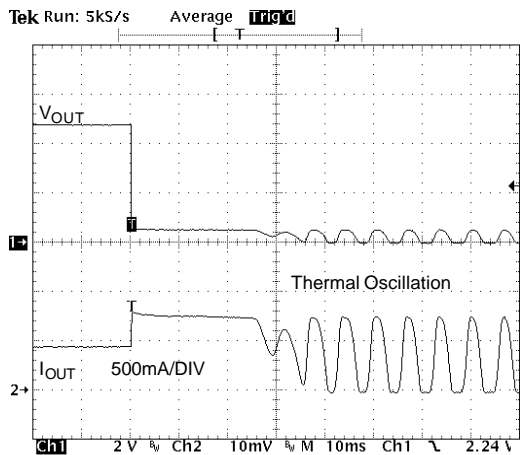

Short Circuit Response Time

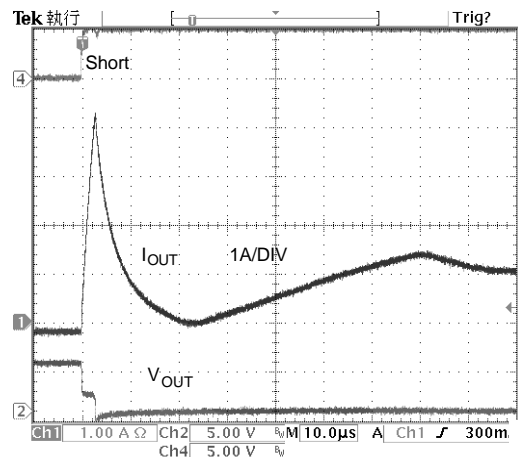

■ PIN DESCRIPTION

MSOP8, SO8

PIN 1/4/6/8: NC:

PIN 2: CTL - TTL compatible control input. It controls the power switch turn-on/turn-off. Active High for AIC1521-1 and active low for AIC1521-0.

PIN 3: IN- Power supply input.

PIN 4: GND- Chip power ground.

PN 7: OUT- MOSFET switch output.

SOT89-5

PIN 1: IN - Power supply input.

PIN 2: GND - Chip power ground.

PIN 3: OUT - MOSFET switch output.

PIN 4: NC

PIN 5: CTL - TTL compatible control input. It controls the power switch turn-on/turn-off. Active High for AIC1521-1 and active low for AIC1521-0.

■ APPLICATION INFORMATIONS

● **Current Limit**

- The current limit threshold is preset internally. It protects the output MOSFET switches from damage due to undesirable short circuit conditions or excess inrush current often encountered during hot plug-in. The AIC1521 allows minimum 500mA continuous load current per Channel.

● **Thermal Protection**

When the chip temperature exceeds 110°C, the thermal protection function works.

● **Supply Filtering**

A 0.1uF to 1uF bypass capacitor from IN to GND, located near the device, is strongly recommended to control supply transients. Without a bypass capacitor, an output short may cause sufficient ringing on the input (from supply lead inductance) to damage internal control circuitry.

● **Transient Droop Requirements**

USB support dynamic attachment (hot plug-in) of peripherals. A current surge is caused by the input capacitance of downstream device. Ferrite beads are recommended in series with all power and ground connector pins. Ferrite beads reduce EMI and limit the inrush current during hot-attachment by filtering high-frequency signals.

● **Short Circuit Transient**

Bulk capacitance provides the short-term transient current needed during a hot-attachment event. With a 33uF, 16V tantalum or 100uF, 10V electrolytic capacitor mounted close to downstream connector should provide transient drop protection.

● **Printed Circuit Layout**

The power circuitry of USB printed circuit boards requires a customized layout to maximize thermal dissipation and to minimize voltage drop and EMI.

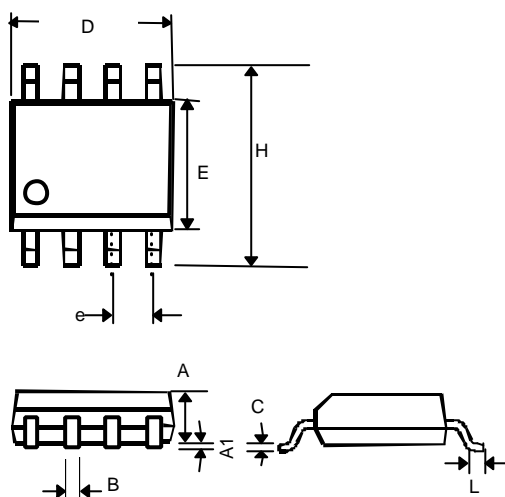
PHYSICAL DIMENSIONS
● MSOP 8 (unit: mm)

SYMBOL	MIN	MAX
A	0.76	0.97
A1	--	0.20
B	0.28	0.38
C	0.13	0.23
D	2.90	3.10
E	2.90	3.10
e	0.65	
H	4.80	5.00
L	0.40	0.66

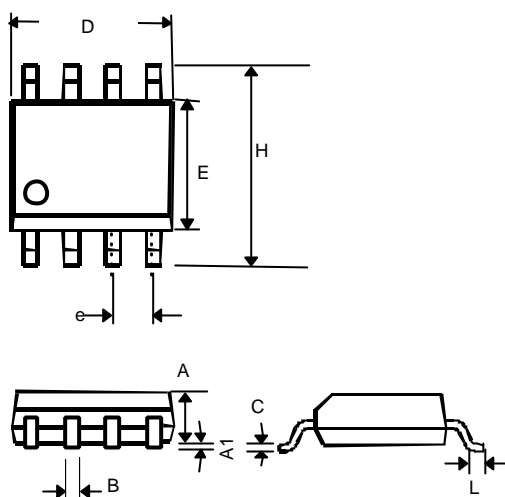
● 8 LEAD PLASTIC SO (unit: mm)

SYMBOL	MIN	MAX
A	1.35	1.75
A1	0.10	0.25
B	0.33	0.51
C	0.19	0.25
D	4.80	5.00
E	3.80	4.00
e	1.27(TYP)	
H	5.80	6.20
L	0.40	1.27

- SOT-89-5 (unit: mm)**

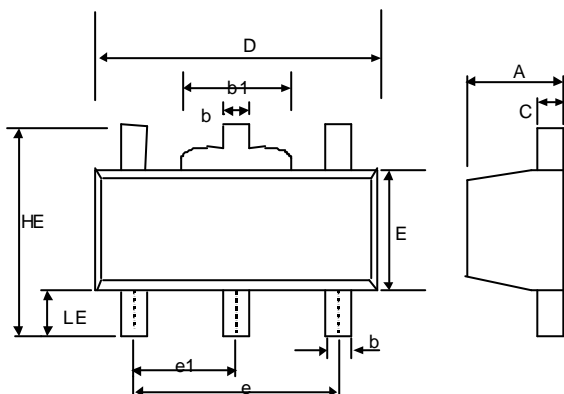

SYMBOL	MIN	MAX
A	1.40	1.60
b	0.32	0.52
b1	1.40	1.80
C	0.30	0.50
D	4.40	4.60
E	2.40	2.60
e	300 (TYP)	
e1	1.50 (TYP)	
HE	4.20	5.00
LE	0.80	---

- SOT-89-5 MARKING**

Part No.	Marking
AIC1521-0CW	BH01
AIC1521-1CW	BH02