



June 2002

## LP2992

# Micropower 250 mA Low-Noise Ultra Low-Dropout Regulator in SOT-23 and LLP Packages

## Designed for Use with Very Low ESR Output Capacitors

### General Description

The LP2992 is a 250 mA, fixed-output voltage regulator designed to provide ultra low-dropout and low noise in battery powered applications.

Using an optimized VIP™ (Vertically Integrated PNP) process, the LP2992 delivers unequalled performance in all specifications critical to battery-powered designs:

**Dropout Voltage:** Typically 450 mV @ 250 mA load, and 5 mV @ 1 mA load.

**Ground Pin Current:** Typically 1500  $\mu$ A @ 250 mA load, and 75  $\mu$ A @ 1 mA load.

**Enhanced Stability:** The LP2992 is stable with output capacitor ESR as low as 5 m $\Omega$ , which allows the use of ceramic capacitors on the output.

**Sleep Mode:** Less than 1  $\mu$ A quiescent current when ON/OFF pin is pulled low.

**Smallest Possible Size:** SOT-23 and LLP packages use absolute minimum board space.

**Precision Output:** 1% tolerance output voltages available (A grade).

**Low Noise:** By adding a 10 nF bypass capacitor, output noise can be reduced to 30  $\mu$ V (typical).

Multiple voltage options, from 1.5V to 5.0V, are available as standard products. Consult factory for custom voltages.

### Features

- Ultra low dropout voltage
- Guaranteed 250 mA output current
- Smallest possible size (SOT-23, LLP package)
- Requires minimum external components
- Stable with low-ESR output capacitor
- <1  $\mu$ A quiescent current when shut down
- Low ground pin current at all loads
- Output voltage accuracy 1% (A Grade)
- High peak current capability
- Wide supply voltage range (16V max)
- Low  $Z_{OUT}$ : 0.3 $\Omega$  typical (10 Hz to 1 MHz)
- Overtemperature/overcurrent protection
- -40°C to +125°C junction temperature range
- Custom voltages available

### Applications

- Cellular Phone
- Palmtop/Laptop Computer
- Personal Digital Assistant (PDA)
- Camcorder, Personal Stereo, Camera

### Block Diagram

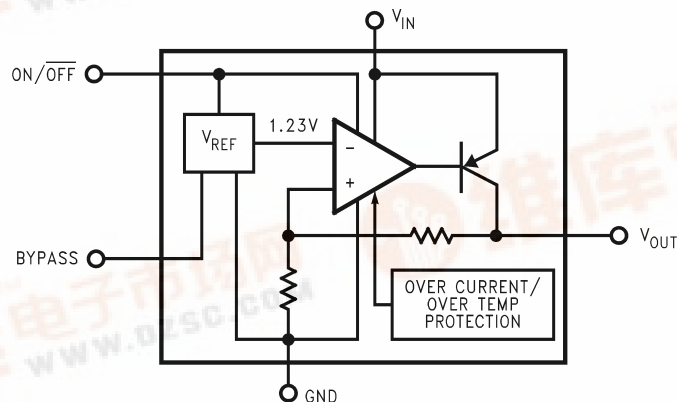

20029401



## Basic Application Circuit

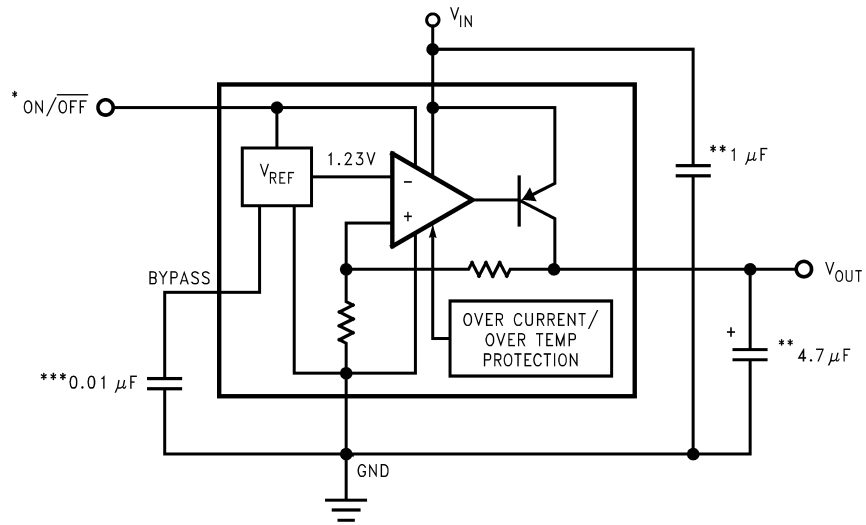

20029402

\*ON/OFF input must be actively terminated. Tie to  $V_{IN}$  if this function is not to be used.

\*\*Minimum capacitance is shown to ensure stability (may be increased without limit). Ceramic capacitor required for output (see Application Hints).

\*\*\*Reduces output noise (may be omitted if application is not noise critical). Use ceramic or film type with very low leakage current (see Application Hints).

## Connection Diagrams

### 5-Lead Small Outline Package (M5)

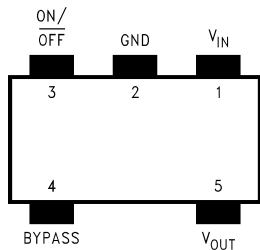

20029403

Top View

See NS Package Number MF05A  
For ordering information see Table 1

### 6-Lead LLP Package (LD)

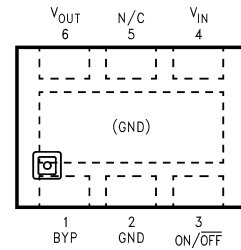

20029446

Top View

See NS Package Number NLDBA006  
Outline Drawing LDE06A

## Ordering Information

TABLE 1. Package Marking and Ordering Information

| Output Voltage (V)                       | Grade | Order Information | Package Marking | Supplied as:                |
|--|-------|-------------------|-----------------|-----------------------------|
| <b>5-Lead Small Outline Package (M5)</b> |       |                   |                 |                             |
| 1.5                                      | A     | LP2992AIM5X-1.5   | LFBA            | 3000 Units on Tape and Reel |
| 1.5                                      | A     | LP2992AIM5-1.5    | LFBA            | 1000 Units on Tape and Reel |
| 1.5                                      | STD   | LP2992IM5X-1.5    | LFBB            | 3000 Units on Tape and Reel |
| 1.5                                      | STD   | LP2992IM5-1.5     | LFBB            | 1000 Units on Tape and Reel |
| 1.8                                      | A     | LP2992AIM5X-1.8   | LFCA            | 3000 Units on Tape and Reel |
| 1.8                                      | A     | LP2992AIM5-1.8    | LFCA            | 1000 Units on Tape and Reel |
| 1.8                                      | STD   | LP2992IM5X-1.8    | LCFB            | 3000 Units on Tape and Reel |
| 1.8                                      | STD   | LP2992IM5-1.8     | LCFB            | 1000 Units on Tape and Reel |
| 2.5                                      | A     | LP2992AIM5X-2.5   | LFDA            | 3000 Units on Tape and Reel |
| 2.5                                      | A     | LP2992AIM5-2.5    | LFDA            | 1000 Units on Tape and Reel |
| 2.5                                      | STD   | LP2992IM5X-2.5    | LFDB            | 3000 Units on Tape and Reel |
| 2.5                                      | STD   | LP2992IM5-2.5     | LFDB            | 1000 Units on Tape and Reel |
| 3.0                                      | A     | LP2992AIM5X-3.0   | LF8A            | 3000 Units on Tape and Reel |
| 3.0                                      | A     | LP2992AIM5-3.0    | LF8A            | 1000 Units on Tape and Reel |
| 3.0                                      | STD   | LP2992IM5X-3.0    | LF8B            | 3000 Units on Tape and Reel |
| 3.0                                      | STD   | LP2992IM5-3.0     | LF8B            | 1000 Units on Tape and Reel |
| 3.3                                      | A     | LP2992AIM5X-3.3   | LFEA            | 3000 Units on Tape and Reel |
| 3.3                                      | A     | LP2992AIM5-3.3    | LFEA            | 1000 Units on Tape and Reel |
| 3.3                                      | STD   | LP2992IM5X-3.3    | LFEB            | 3000 Units on Tape and Reel |
| 3.3                                      | STD   | LP2992IM5-3.3     | LFEB            | 1000 Units on Tape and Reel |
| 5.0                                      | A     | LP2992AIM5X-5.0   | LFFA            | 3000 Units on Tape and Reel |
| 5.0                                      | A     | LP2992AIM5-5.0    | LFFA            | 1000 Units on Tape and Reel |
| 5.0                                      | STD   | LP2992IM5X-5.0    | LFFB            | 3000 Units on Tape and Reel |
| 5.0                                      | STD   | LP2992IM5-5.0     | LFFB            | 1000 Units on Tape and Reel |
| <b>6-Lead LLP Package (LDE06A)</b>       |       |                   |                 |                             |
| 1.5                                      | A     | LP2992AILDX-1.5   | L011A           | 4500 Units on Tape and Reel |
| 1.5                                      | A     | LP2992AILD-1.5    | L011A           | 1000 Units on Tape and Reel |
| 1.5                                      | STD   | LP2992ILD-1.5     | L011AB          | 4500 Units on Tape and Reel |
| 1.5                                      | STD   | LP2992ILD-1.5     | L011AB          | 1000 Units on Tape and Reel |
| 1.8                                      | A     | LP2992AILDX-1.8   | L012A           | 4500 Units on Tape and Reel |
| 1.8                                      | A     | LP2992AILD-1.8    | L012A           | 1000 Units on Tape and Reel |
| 1.8                                      | STD   | LP2992ILD-1.8     | L012AB          | 4500 Units on Tape and Reel |
| 1.8                                      | STD   | LP2992ILD-1.8     | L012AB          | 1000 Units on Tape and Reel |
| 2.5                                      | A     | LP2992AILDX-2.5   | L013A           | 4500 Units on Tape and Reel |
| 2.5                                      | A     | LP2992AILD-2.5    | L013A           | 1000 Units on Tape and Reel |
| 2.5                                      | STD   | LP2992ILD-2.5     | L013AB          | 4500 Units on Tape and Reel |
| 2.5                                      | STD   | LP2992ILD-2.5     | L013AB          | 1000 Units on Tape and Reel |
| 3.3                                      | A     | LP2992AILDX-3.3   | L014A           | 4500 Units on Tape and Reel |
| 3.3                                      | A     | LP2992AILD-3.3    | L014A           | 1000 Units on Tape and Reel |
| 3.3                                      | STD   | LP2992ILD-3.3     | L014AB          | 4500 Units on Tape and Reel |
| 3.3                                      | STD   | LP2992ILD-3.3     | L014AB          | 1000 Units on Tape and Reel |
| 5.0                                      | A     | LP2992AILDX-5.0   | L015A           | 4500 Units on Tape and Reel |
| 5.0                                      | A     | LP2992AILD-5.0    | L015A           | 1000 Units on Tape and Reel |
| 5.0                                      | STD   | LP2992ILD-5.0     | L015AB          | 4500 Units on Tape and Reel |
| 5.0                                      | STD   | LP2992ILD-5.0     | L015AB          | 1000 Units on Tape and Reel |

### Absolute Maximum Ratings (Note 1)

If Military/Aerospace specified devices are required, please contact the National Semiconductor Sales Office/Distributors for availability and specifications.

|                                      |                    |
|--------------------------------------|--------------------|
| Storage Temperature Range            | -65°C to +150°C    |
| Operating Junction Temperature Range | -40°C to +125°C    |
| Lead Temp. (Soldering, 5 sec.)       | 260°C              |
| ESD Rating (Note 2)                  | 2 kV               |
| Power Dissipation (Note 3)           | Internally Limited |

|   |                         |
|---|-------------------------|
| Input Supply Voltage (Survival)           | -0.3V to +16V           |
| Input Supply Voltage (Operating)          | 2.2V to +16V            |
| Shutdown Input Voltage (Survival)         | -0.3V to +16V           |
| Output Voltage (Survival, (Note 4))       | -0.3V to +9V            |
| I <sub>OUT</sub> (Survival)               | Short Circuit Protected |
| Input-Output Voltage (Survival, (Note 5)) | -0.3V to +16V           |

### Electrical Characteristics

Limits in standard typeface are for T<sub>J</sub> = 25°C. and limits in **boldface type** apply over the full operating temperature range. Unless otherwise specified: V<sub>IN</sub> = V<sub>O</sub>(NOM) + 1V, I<sub>L</sub> = 1 mA, C<sub>IN</sub> = 1 μF, C<sub>OUT</sub> = 4.7 μF, V<sub>ON/OFF</sub> = 2V.

| Symbol                             | Parameter  | Conditions                                      | Typ         | LP2992AI-X.X<br>(Note 6) |             | LP2992I-X.X<br>(Note 6) |             | Units             |
|------------------------------------|--|---|-------------|--------------------------|-------------|-------------------------|-------------|-------------------|
|                                    |  |   |             | Min                      | Max         | Min                     | Max         |                   |
| ΔV <sub>O</sub>                    | Output Voltage Tolerance                                     | I <sub>L</sub> = 1 mA                           |             | -1.0                     | 1.0         | -1.5                    | 1.5         | %V <sub>NOM</sub> |
|                                    |  | 1 mA ≤ I <sub>L</sub> ≤ 50 mA                   |             | -1.5                     | 1.5         | -2.5                    | 2.5         |                   |
|                                    |  | 1 mA ≤ I <sub>L</sub> ≤ 250 mA                  |             | <b>-2.5</b>              | <b>2.5</b>  | <b>-3.5</b>             | <b>3.5</b>  |                   |
| $\frac{\Delta V_O}{\Delta V_{IN}}$ | Output Voltage   | V <sub>O</sub> (NOM)+1V ≤ V <sub>IN</sub> ≤ 16V | 0.007       |                          | 0.014       |                         | 0.014       | %V                |
|                                    | Line Regulation  |   |             | <b>0.032</b>             |             | <b>0.032</b>            |             |                   |
| V <sub>IN</sub> (min)              | Minimum input voltage required to maintain output regulation |   | 2.05        |                          | <b>2.20</b> |                         | <b>2.20</b> | V                 |
| V <sub>IN</sub> -V <sub>O</sub>    | Dropout Voltage (Note 7)                                     | I <sub>L</sub> = 0                              | 0.5         |                          | 2.5         |                         | 2.5         | mV                |
|                                    |  | I <sub>L</sub> = 1 mA                           | 5           |                          | <b>4</b>    |                         | <b>4</b>    |                   |
|                                    |  | I <sub>L</sub> = 50 mA                          | 100         |                          | 9           |                         | 9           |                   |
|                                    |  | I <sub>L</sub> = 150 mA                         | 260         |                          | <b>12</b>   |                         | <b>12</b>   |                   |
|                                    |  | I <sub>L</sub> = 250 mA                         | 450         |                          | 125         |                         | 125         |                   |
| I <sub>GND</sub>                   | Ground Pin Current   | I <sub>L</sub> = 0                              | 65          |                          | 95          |                         | 95          | μA                |
|                                    |  | I <sub>L</sub> = 1 mA                           | 75          |                          | <b>125</b>  |                         | <b>125</b>  |                   |
|                                    |  | I <sub>L</sub> = 50 mA                          | 350         |                          | 110         |                         | 110         |                   |
|                                    |  | I <sub>L</sub> = 150 mA                         | 850         |                          | <b>170</b>  |                         | <b>170</b>  |                   |
|                                    |  | I <sub>L</sub> = 250 mA                         | 1500        |                          | 600         |                         | 600         |                   |
|                                    |  | V <sub>ON/OFF</sub> < 0.3V                      | 0.01        |                          | <b>1000</b> |                         | <b>1000</b> |                   |
|                                    |  | V <sub>ON/OFF</sub> < 0.15V                     | <b>0.05</b> |                          | 1500        |                         | 1500        |                   |
| V <sub>ON/OFF</sub>                | ON/OFF Input Voltage (Note 8)                                | High = O/P ON                                   | 1.4         | <b>1.6</b>               |             | <b>1.6</b>              |             | V                 |
|                                    |  | Low = O/P OFF                                   | 0.55        |                          | <b>0.15</b> |                         | <b>0.15</b> |                   |

## Electrical Characteristics (Continued)

Limits in standard typeface are for  $T_J = 25^\circ\text{C}$ . and limits in **boldface type** apply over the full operating temperature range. Unless otherwise specified:  $V_{IN} = V_O(\text{NOM}) + 1\text{V}$ ,  $I_L = 1\text{ mA}$ ,  $C_{IN} = 1\ \mu\text{F}$ ,  $C_{OUT} = 4.7\ \mu\text{F}$ ,  $V_{ON/OFF} = 2\text{V}$ .

| Symbol                                 | Parameter                  | Conditions  | Typ  | LP2992AI-X.X<br>(Note 6) |           | LP2992I-X.X<br>(Note 6) |           | Units         |
|--|----------------------------|---|------|--------------------------|-----------|-------------------------|-----------|---------------|
|  |                            |   |      | Min                      | Max       | Min                     | Max       |               |
| $I_{ON/OFF}$                           | ON/OFF Input Current       | $V_{ON/OFF} = 0$  | 0.01 |                          | <b>-2</b> |                         | <b>-2</b> | $\mu\text{A}$ |
|  |                            | $V_{ON/OFF} = 5\text{V}$  | 5    |                          | <b>15</b> |                         | <b>15</b> |               |
| $e_n$                                  | Output Noise Voltage (RMS) | BW = 300 Hz to 50 kHz,<br>$C_{OUT} = 10\ \mu\text{F}$<br>$C_{BYPASS} = 10\ \text{nF}$ | 30   |                          |           |                         |           | $\mu\text{V}$ |
| $\frac{\Delta V_{OUT}}{\Delta V_{IN}}$ | Ripple Rejection           | $f = 1\ \text{kHz}$ , $C_{BYPASS} = 10\ \text{nF}$<br>$C_{OUT} = 10\ \mu\text{F}$     | 45   |                          |           |                         |           | dB            |
| $I_{O(SC)}$                            | Short Circuit Current      | $R_L = 0$ (Steady State)<br>(Note 9)  | 400  |                          |           |                         |           | mA            |
| $I_{O(PK)}$                            | Peak Output Current        | $V_{OUT} \geq V_O(\text{NOM}) - 5\%$  | 350  |                          |           |                         |           | mA            |

**Note 1:** "Absolute Maximum Ratings" indicate limits beyond which damage to the component may occur. Electrical specifications do not apply when operating the device outside of its rated operating conditions.

**Note 2:** The ESD rating of pins 3 and 4 for the SOT-23 package, or pins 1 and 3 for the LLP package, is 1 kV.

**Note 3:** The maximum allowable power dissipation is a function of the maximum junction temperature,  $T_J(\text{MAX})$ , the junction-to-ambient thermal resistance,  $\theta_{J-A}$ , and the ambient temperature,  $T_A$ . The maximum allowable power dissipation at any ambient temperature is calculated using:

$$P(\text{MAX}) = \frac{T_J(\text{MAX}) - T_A}{\theta_{J-A}}$$

Where the value of  $\theta_{J-A}$  for the SOT-23 package is  $220^\circ\text{C/W}$  in a typical PC board mounting and the LLP package is  $65^\circ\text{C/W}$ . Exceeding the maximum allowable dissipation will cause excessive die temperature, and the regulator will go into thermal shutdown.

**Note 4:** If used in a dual-supply system where the regulator load is returned to a negative supply, the LP2992 output must be diode-clamped to ground.

**Note 5:** The output PNP structure contains a diode between the  $V_{IN}$  to  $V_{OUT}$  terminals that is normally reverse-biased. Reversing the polarity from  $V_{IN}$  to  $V_{OUT}$  will turn on this diode.

**Note 6:** Limits are 100% production tested at  $25^\circ\text{C}$ . Limits over the operating temperature range are guaranteed through correlation using Statistical Quality Control (SQC) methods. The limits are used to calculate National's Average Outgoing Quality Level (AOQL).

**Note 7:**  $V_{IN}$  must be the greater of  $2.2\text{V}$  or  $V_{OUT(\text{nom})} + \text{Dropout Voltage}$  to maintain output regulation. Dropout voltage is defined as the input to output differential at which the output voltage drops 2% below the value measured with a 1V differential.

**Note 8:** The ON/OFF input must be properly driven to prevent possible misoperation. For details, refer to Application Hints.

**Note 9:** The LP2992 has foldback current limiting which allows a high peak current when  $V_{OUT} > 0.5\text{V}$ , and then reduces the maximum output current as  $V_{OUT}$  is forced to ground (see Typical Performance Characteristics curves).

**Typical Performance Characteristics** Unless otherwise specified:  $C_{IN} = 1\mu F$ ,  $C_{OUT} = 4.7\mu F$ ,  $V_{IN} = V_{OUT(NOM)} + 1$ ,  $T_A = 25^\circ C$ , ON/OFF pin is tied to  $V_{IN}$ .

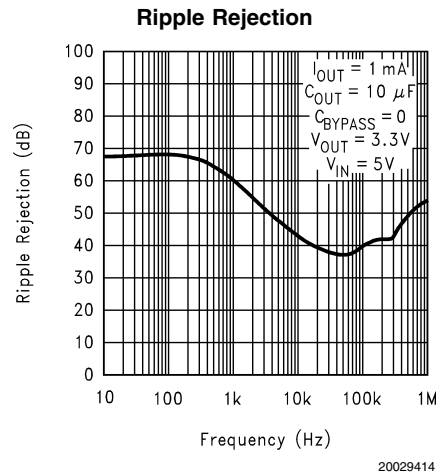
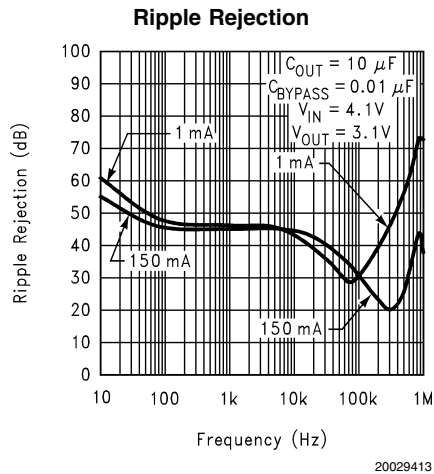
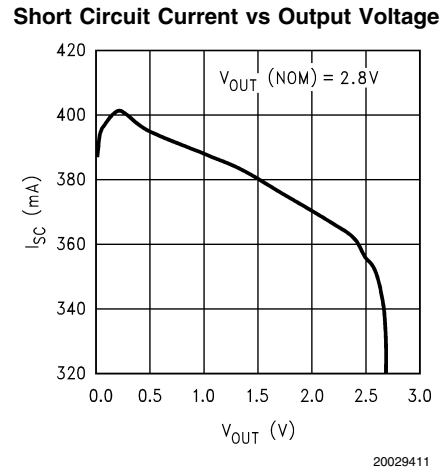
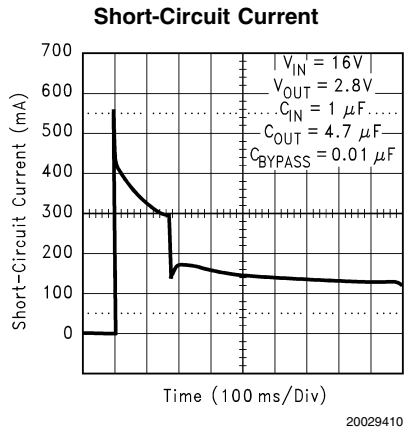
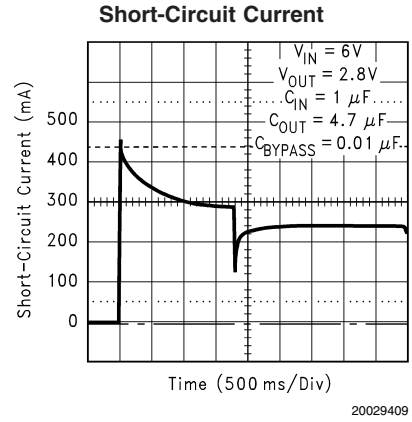
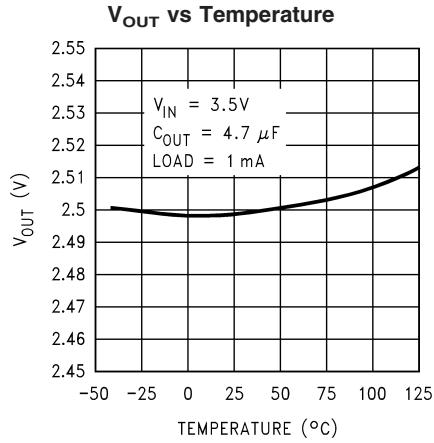

**Typical Performance Characteristics** Unless otherwise specified:  $C_{IN} = 1\mu F$ ,  $C_{OUT} = 4.7\mu F$ ,  $V_{IN} = V_{OUT(NOM)} + 1$ ,  $T_A = 25^\circ C$ , ON/OFF pin is tied to  $V_{IN}$ . (Continued)

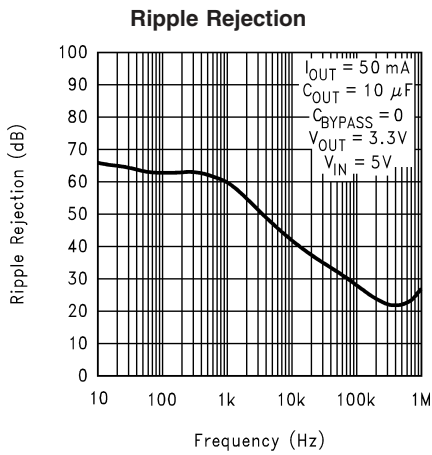

20029415

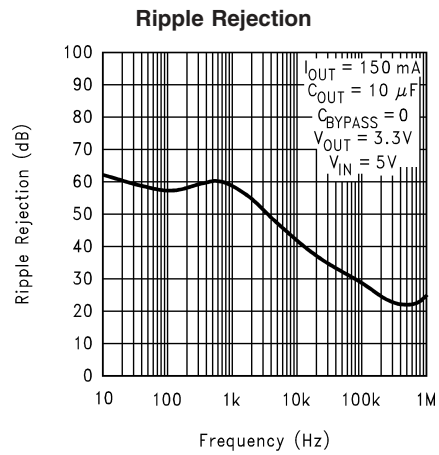

20029416

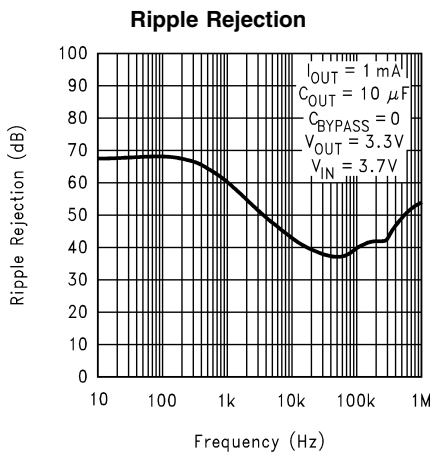

20029417

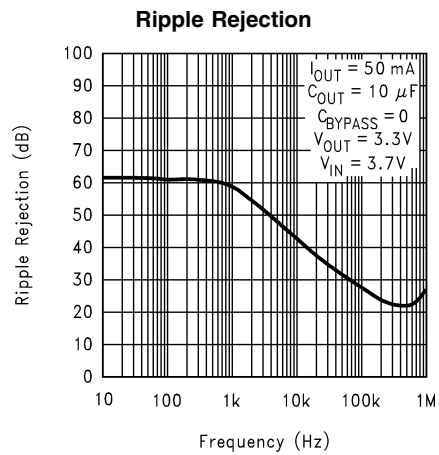

20029418

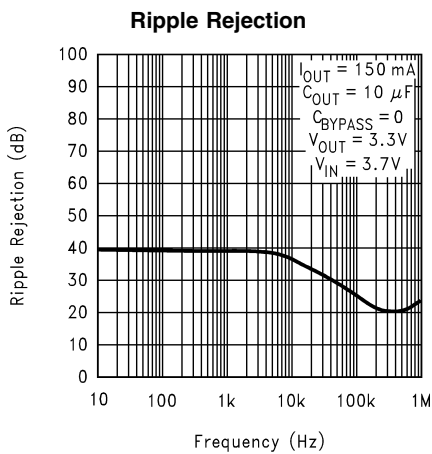

20029419

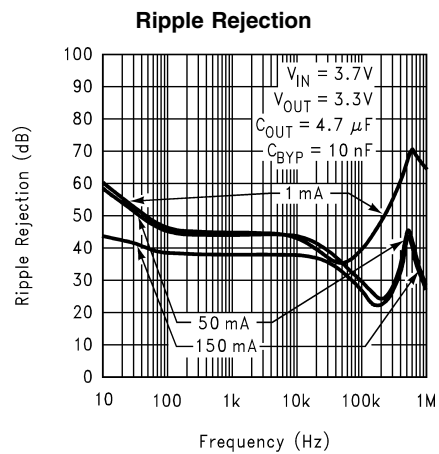

20029423

**Typical Performance Characteristics** Unless otherwise specified:  $C_{IN} = 1\mu F$ ,  $C_{OUT} = 4.7\mu F$ ,  $V_{IN} = V_{OUT(NOM)} + 1$ ,  $T_A = 25^\circ C$ , ON/OFF pin is tied to  $V_{IN}$ . (Continued)

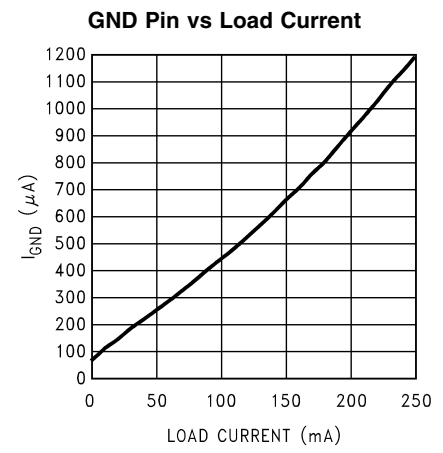
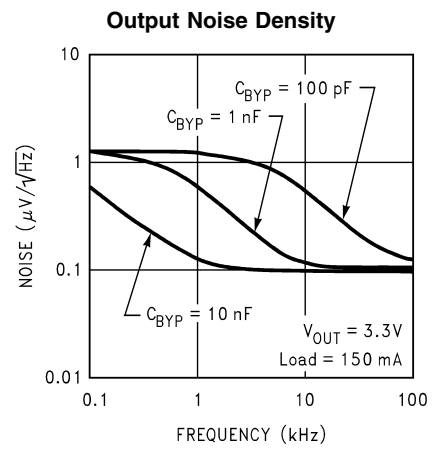
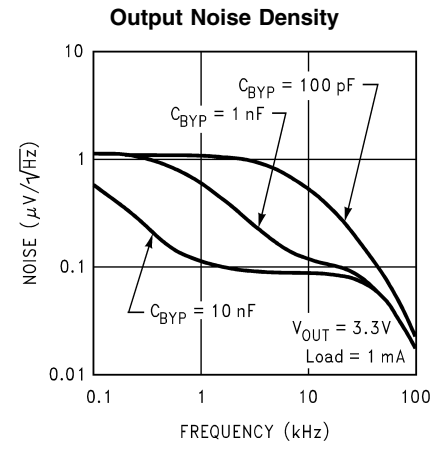
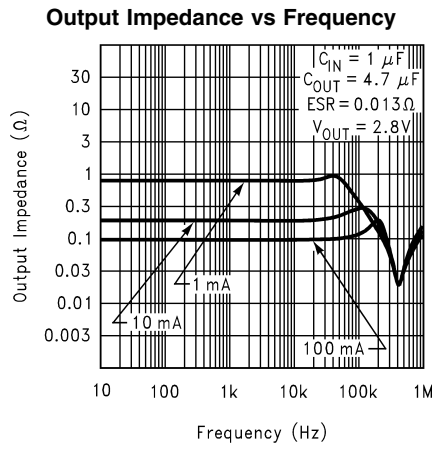
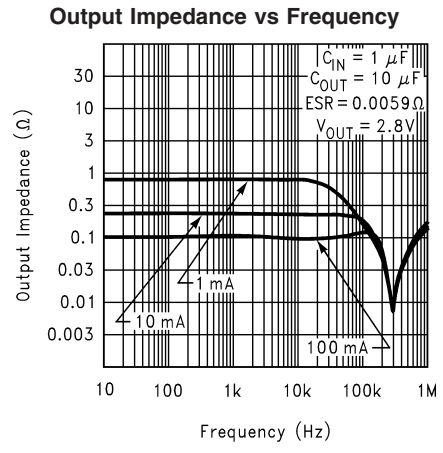
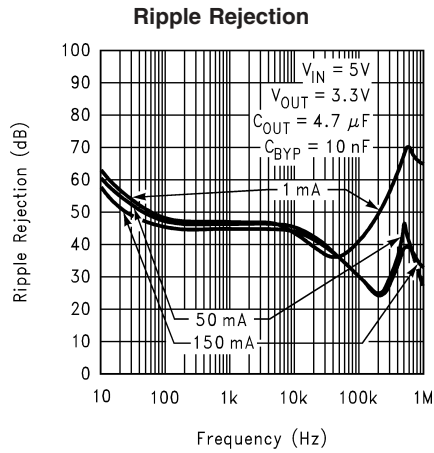



**Typical Performance Characteristics** Unless otherwise specified:  $C_{IN} = 1\mu F$ ,  $C_{OUT} = 4.7\mu F$ ,  $V_{IN} = V_{OUT(NOM)} + 1$ ,  $T_A = 25^\circ C$ , ON/OFF pin is tied to  $V_{IN}$ . (Continued)

**Dropout Voltage vs Temperature**

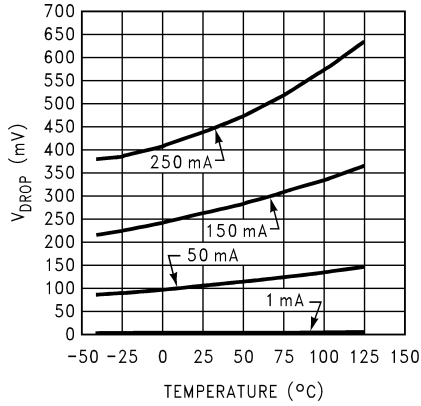

20029427

**Input Current vs Pin**

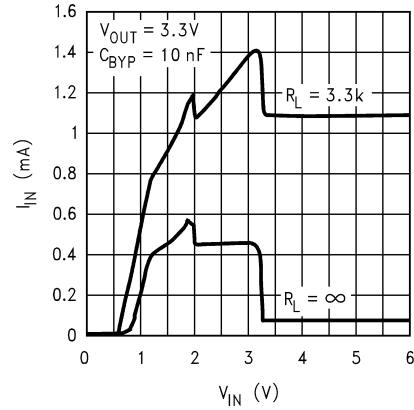

20029429

**I<sub>GND</sub> vs Load and Temperature**

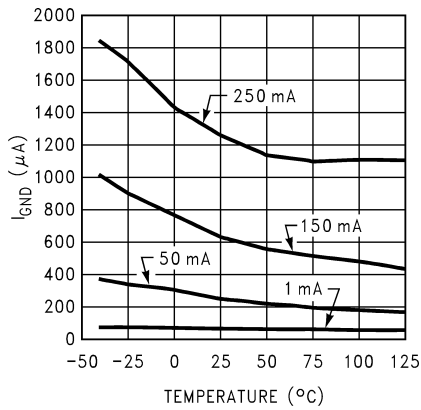

20029430

**Instantaneous Short Circuit Current**

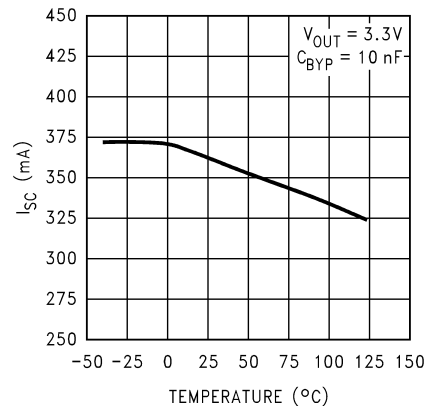

20029431

**Load Transient Response**

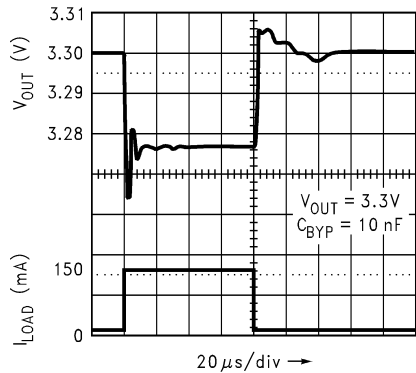

20029433

**Load Transient Response**

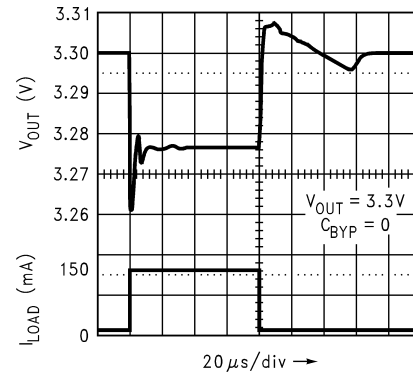

20029434

**Typical Performance Characteristics** Unless otherwise specified:  $C_{IN} = 1\mu F$ ,  $C_{OUT} = 4.7\mu F$ ,  $V_{IN} = V_{OUT(NOM)} + 1$ ,  $T_A = 25^\circ C$ , ON/OFF pin is tied to  $V_{IN}$ . (Continued)

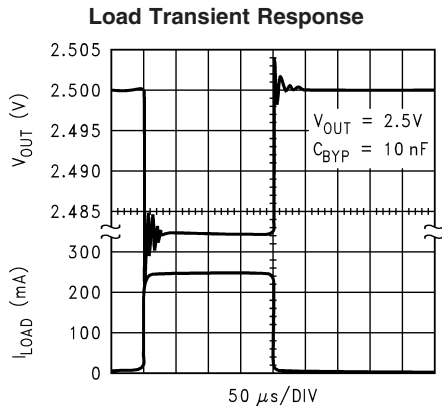

20029447

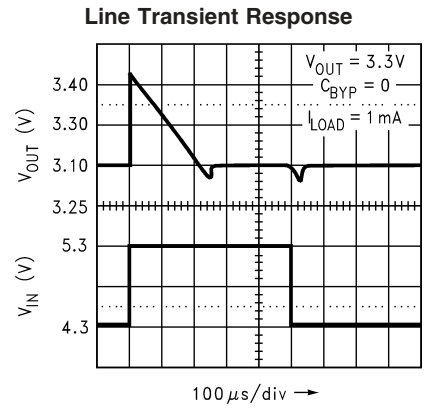

20029435

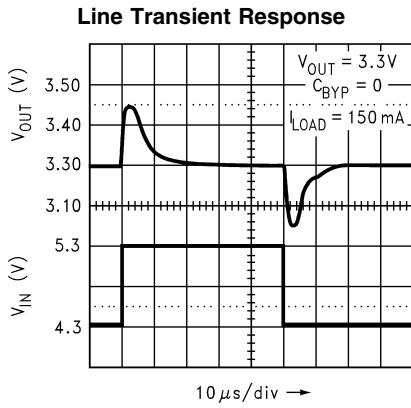

20029436

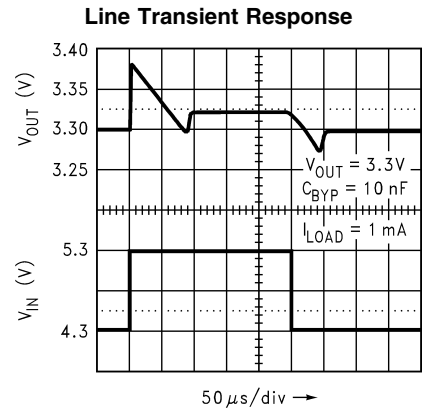

20029437

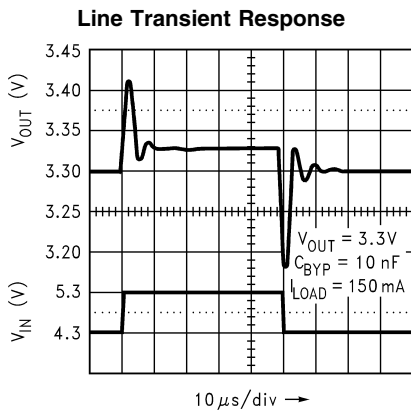

20029438

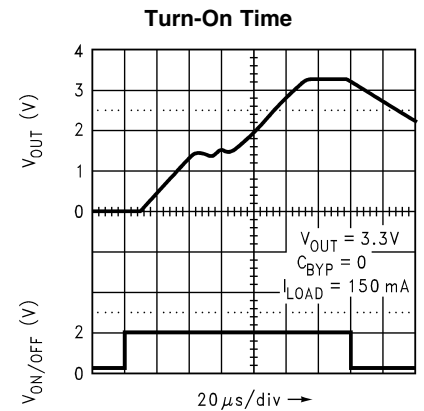

20029439

**Typical Performance Characteristics** Unless otherwise specified:  $C_{IN} = 1\mu\text{F}$ ,  $C_{OUT} = 4.7\mu\text{F}$ ,  $V_{IN} = V_{OUT(NOM)} + 1$ ,  $T_A = 25^\circ\text{C}$ , ON/OFF pin is tied to  $V_{IN}$ . (Continued)

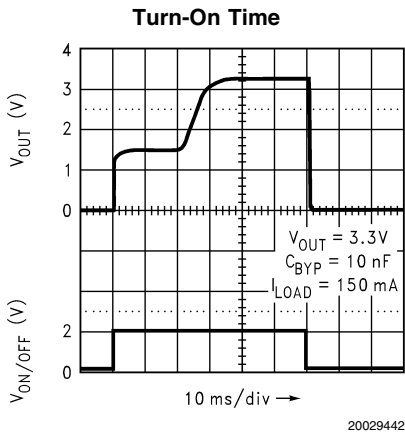
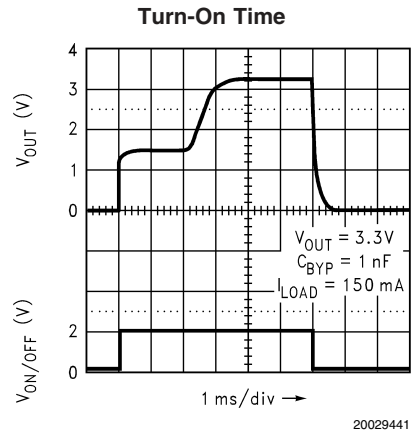
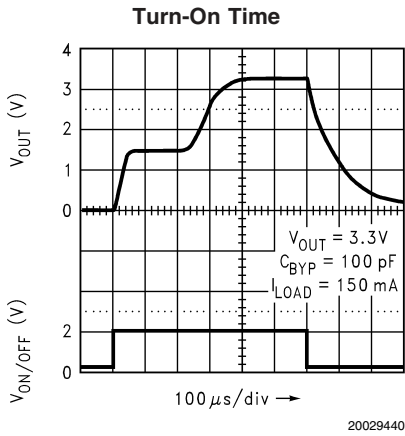

## Application Hints

### EXTERNAL CAPACITORS

Like any low-dropout regulator, the LP2992 requires external capacitors for regulator stability. These capacitors must be correctly selected for good performance.

#### Input Capacitor

An input capacitor whose capacitance is  $\geq 1 \mu\text{F}$  is required between the LP2992 input and ground (the amount of capacitance may be increased without limit).

This capacitor must be located a distance of not more than 1 cm from the input pin and returned to a clean analog ground. Any good quality ceramic, tantalum, or film capacitor may be used at the input.

**Important:** Tantalum capacitors can suffer catastrophic failure due to surge current when connected to a low-impedance source of power (like a battery or very large capacitor). If a Tantalum capacitor is used at the input, it must be guaranteed by the manufacturer to have a surge current rating sufficient for the application.

There are no requirements for ESR on the input capacitor, but tolerance and temperature coefficient must be considered when selecting the capacitor to ensure the capacitance will be  $\geq 1 \mu\text{F}$  over the entire operating temperature range.

#### Output Capacitor:

The LP2992 is designed specifically to work with ceramic output capacitors, utilizing circuitry which allows the regulator to be stable across the entire range of output current with an output capacitor whose ESR is as low as  $5 \text{ m}\Omega$ . It may also be possible to use Tantalum or film capacitors at the output, but these are not as attractive for reasons of size and cost (see next section Capacitor Characteristics).

The output capacitor must meet the requirement for minimum amount of capacitance and also have an ESR (equivalent series resistance) value which is within the stable range. Curves are provided which show the stable ESR range as a function of load current (see ESR graph below).

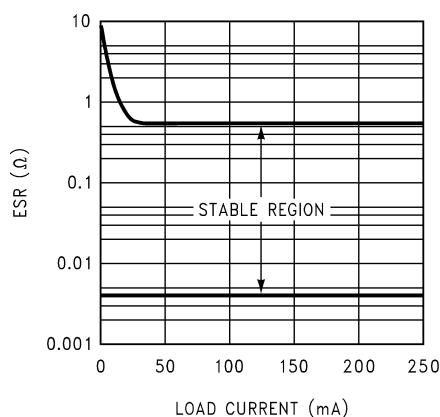

20029407

**Important:** The output capacitor must maintain its ESR within the stable region over the full operating temperature range of the application to assure stability.

The LP2992 requires a minimum of  $4.7 \mu\text{F}$  on the output (output capacitor size can be increased without limit).

It is important to remember that capacitor tolerance and variation with temperature must be taken into consideration when selecting an output capacitor so that the minimum required amount of output capacitance is provided over the full operating temperature range. It should be noted that

ceramic capacitors can exhibit large changes in capacitance with temperature (see next section, *Capacitor Characteristics*).

The output capacitor must be located not more than 1 cm from the output pin and returned to a clean analog ground.

#### Noise Bypass Capacitor:

Connecting a  $10 \text{ nF}$  capacitor to the Bypass pin significantly reduces noise on the regulator output. It should be noted that the capacitor is connected directly to a high-impedance circuit in the bandgap reference.

Because this circuit has only a few microamperes flowing in it, any significant loading on this node will cause a change in the regulated output voltage. For this reason, DC leakage current through the noise bypass capacitor must never exceed  $100 \text{ nA}$ , and should be kept as low as possible for best output voltage accuracy.

The types of capacitors best suited for the noise bypass capacitor are ceramic and film. High-quality ceramic capacitors with either NPO or COG dielectric typically have very low leakage.  $10 \text{ nF}$  polypropylene and polycarbonate film capacitors are available in small surface-mount packages and typically have extremely low leakage current.

### CAPACITOR CHARACTERISTICS

The LP2992 was designed to work with ceramic capacitors on the output to take advantage of the benefits they offer: for capacitance values in the  $2.2 \mu\text{F}$  to  $10 \mu\text{F}$  range, ceramics are the least expensive and also have the lowest ESR values (which makes them best for eliminating high-frequency noise). The ESR of a typical  $4.7 \mu\text{F}$  ceramic capacitor is in the range of  $5 \text{ m}\Omega$  to  $10 \text{ m}\Omega$ , which easily meets the ESR limits required for stability by the LP2992.

One disadvantage of ceramic capacitors is that their capacitance can vary with temperature. Most large value ceramic capacitors ( $\geq 2.2 \mu\text{F}$ ) are manufactured with the Z5U or Y5V temperature characteristic, which results in the capacitance dropping by more than 50% as the temperature goes from  $25^\circ\text{C}$  to  $85^\circ\text{C}$ .

This could cause problems if a  $4.7 \mu\text{F}$  capacitor were used on the output since it will drop down to approximately  $2.3 \mu\text{F}$  at high ambient temperatures (which could cause the LP2992 to oscillate). If Z5U or Y5V capacitors are used on the output, a minimum capacitance value of  $10 \mu\text{F}$  must be observed.

A better choice for temperature coefficient in ceramic capacitors is X7R, which holds the capacitance within  $\pm 15\%$ . Unfortunately, the larger values of capacitance are not offered by all manufacturers in the X7R dielectric.

#### Tantalum:

Tantalum capacitors are less desirable than ceramics for use as output capacitors because they are more expensive when comparing equivalent capacitance and voltage ratings in the  $1 \mu\text{F}$  to  $4.7 \mu\text{F}$  range.

Another important consideration is that Tantalum capacitors have higher ESR values than equivalent size ceramics. This means that while it may be possible to find a Tantalum capacitor with an ESR value within the stable range, it would have to be larger in capacitance (which means bigger and more costly) than a ceramic capacitor with the same ESR value.

## Application Hints (Continued)

It should also be noted that the ESR of a typical Tantalum will increase about 2:1 as the temperature goes from 25°C down to -40°C, so some guard band must be allowed.

### ON/OFF INPUT OPERATION

The LP2992 is shut off by driving the ON/OFF input low, and turned on by pulling it high. If this feature is not to be used, the ON/OFF input should be tied to  $V_{IN}$  to keep the regulator output on at all times.

To assure proper operation, the signal source used to drive the ON/OFF input must be able to swing above and below the specified turn-on/turn-off voltage thresholds listed in the Electrical Characteristics section under  $V_{ON/OFF}$ . To prevent mis-operation, the turn-on (and turn-off) voltage signals applied to the ON/OFF input must have a slew rate which is  $\geq 40$  mV/ $\mu$ s.

**Caution:** the regulator output voltage can not be guaranteed if a slow-moving AC (or DC) signal is applied that is in the range between the specified turn-on and turn-off voltages listed under the electrical specification  $V_{ON/OFF}$  (see Electrical Characteristics).

### REVERSE INPUT-OUTPUT VOLTAGE

The PNP power transistor used as the pass element in the LP2992 has an inherent diode connected between the regulator output and input. During normal operation (where the input voltage is higher than the output) this diode is reverse-biased.

However, if the output is pulled above the input, this diode will turn ON and current will flow into the regulator output. In such cases, a parasitic SCR can latch which will allow a high current to flow into  $V_{IN}$  (and out the ground pin), which can damage the part.

In any application where the output may be pulled above the input, an external Schottky diode must be connected from  $V_{IN}$  to  $V_{OUT}$  (cathode on  $V_{IN}$ , anode on  $V_{OUT}$ ), to limit the reverse voltage across the LP2992 to 0.3V (see Absolute Maximum Ratings).

### LLP Mounting

The LLP package requires specific mounting techniques which are detailed in National Semiconductor Application Note # 1187. Referring to the section **PCB Design Recommendations**, it should be noted that the pad style which should be used with the LLP package is the NSMD (non-solder mask defined) type.

**Physical Dimensions** inches (millimeters)  
unless otherwise noted

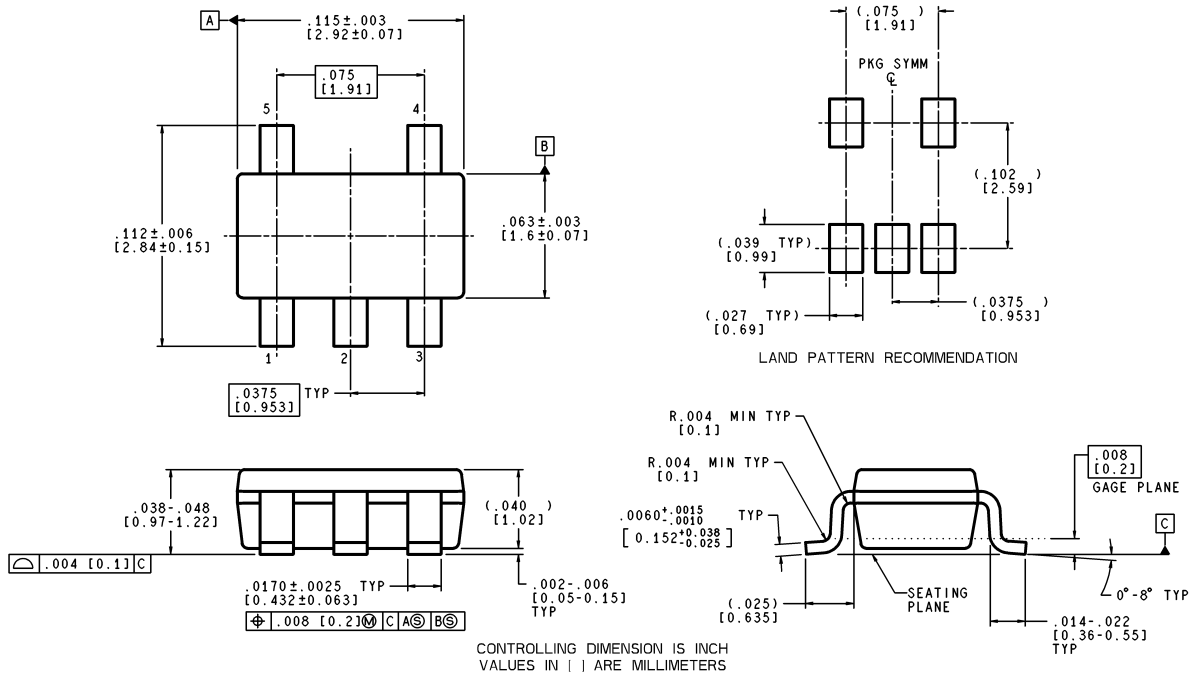

MF05A (Rev A)

**5-Lead Small Outline Package (M5)**  
**NS Package Number MF05A**  
For Order Numbers, refer to *Table 1* in the "Ordering Information" section of this document.

**Physical Dimensions** inches (millimeters) unless otherwise noted (Continued)

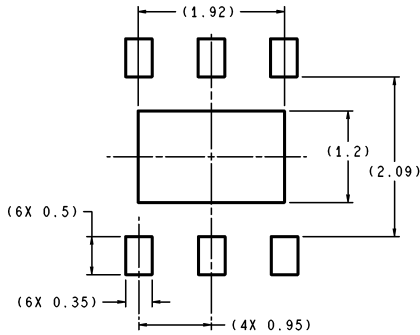

DIMENSIONS ARE IN MILLIMETERS

RECOMMENDED LAND PATTERN  
1:1 RATIO WITH PKG SOLDER PADS

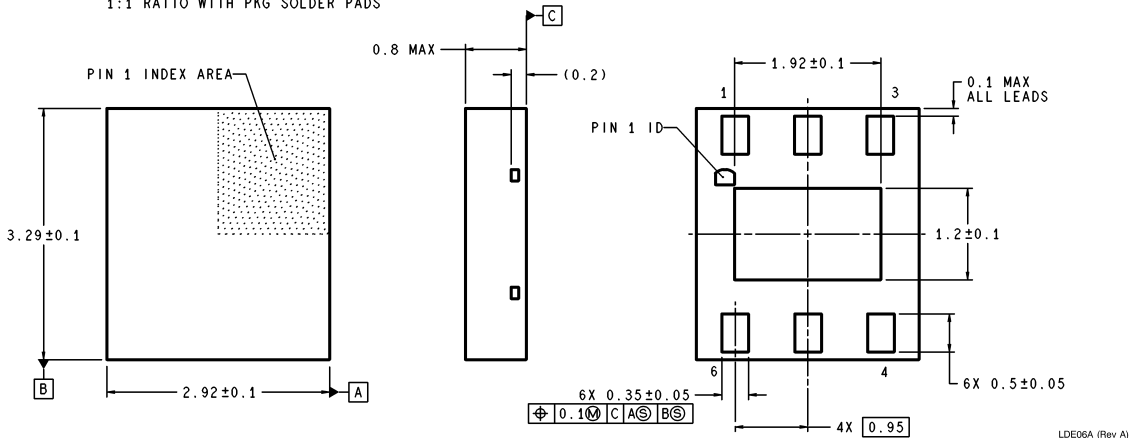

**6-Lead LLP Package (LD)  
NS Package Number LDE06A**

**LIFE SUPPORT POLICY**

NATIONAL'S PRODUCTS ARE NOT AUTHORIZED FOR USE AS CRITICAL COMPONENTS IN LIFE SUPPORT DEVICES OR SYSTEMS WITHOUT THE EXPRESS WRITTEN APPROVAL OF THE PRESIDENT AND GENERAL COUNSEL OF NATIONAL SEMICONDUCTOR CORPORATION. As used herein:

1. Life support devices or systems are devices or systems which, (a) are intended for surgical implant into the body, or (b) support or sustain life, and whose failure to perform when properly used in accordance with instructions for use provided in the labeling, can be reasonably expected to result in a significant injury to the user.
2. A critical component is any component of a life support device or system whose failure to perform can be reasonably expected to cause the failure of the life support device or system, or to affect its safety or effectiveness.

**National Semiconductor Corporation**  
Americas  
Email: support@nsc.com

**National Semiconductor Europe**  
Fax: +49 (0) 180-530 85 86  
Email: europe.support@nsc.com  
Deutsch Tel: +49 (0) 69 9508 6208  
English Tel: +44 (0) 870 24 0 2171  
Français Tel: +33 (0) 1 41 91 8790

**National Semiconductor Asia Pacific Customer Response Group**  
Tel: 65-2544466  
Fax: 65-2504466  
Email: ap.support@nsc.com

**National Semiconductor Japan Ltd.**  
Tel: 81-3-5639-7560  
Fax: 81-3-5639-7507

www.national.com