



**SMAJ5.0A-TR,CA-TR
SMAJ188A-TR,CA-TR**

TRANSIL™

FEATURES

- PEAK PULSE POWER : 400 W (10/1000µs)
- STAND OFF VOLTAGE RANGE :
From 5V to 188V.
- UNI AND BIDIRECTIONAL TYPES
- LOW CLAMPING FACTOR
- FAST RESPONSE TIME
- JEDEC REGISTERED PACKAGE OUTLINE

DESCRIPTION

The SMAJ series are TRANSIL™ diodes designed specifically for protecting sensitive equipment against transient overvoltages. The SMA package allows save spacing on high density printed circuit boards.

Transil diodes provide high overvoltage protection by clamping action. Their instantaneous response to transient overvoltages makes them particularly suited to protect voltage sensitive devices such as MOS Technology and low voltage supplied IC's.



ABSOLUTE MAXIMUM RATINGS (T_{amb} = 25°C)

Symbol	Parameter		Value	Unit
P _{PP}	Peak pulse power dissipation (see note 1)	T _j initial = T _{amb}	400	W
P	Power dissipation on infinite heatsink	T _{amb} = 50°C	3.3	W
I _{FSM}	Non repetitive surge peak forward current for unidirectional types	tp = 10ms T _j initial = T _{amb}	40	A
T _{stg} T _j	Storage temperature range Maximum junction temperature		- 65 to + 175 150	°C °C
T _L	Maximum lead temperature for soldering during 10 s.		260	°C

Note 1 : For a surge greater than the maximum values, the diode will fail in short-circuit.

THERMAL RESISTANCES

Symbol	Parameter	Value	Unit
R _{th (j-l)}	Junction to leads	30	°C/W
R _{th (j-a)}	Junction to ambient on printed circuit on recommended pad layout	120	°C/W



SMAJxxxA-TR, CA-TR

ELECTRICAL CHARACTERISTICS (T_{amb} = 25°C)

Symbol	Parameter
V _{RM}	Stand-off voltage
V _{BR}	Breakdown voltage
V _{CL}	Clamping voltage
I _{RM}	Leakage current @ V _{RM}
I _{PP}	Peak pulse current
α _T	Voltage temperature coefficient
V _F	Forward voltage drop

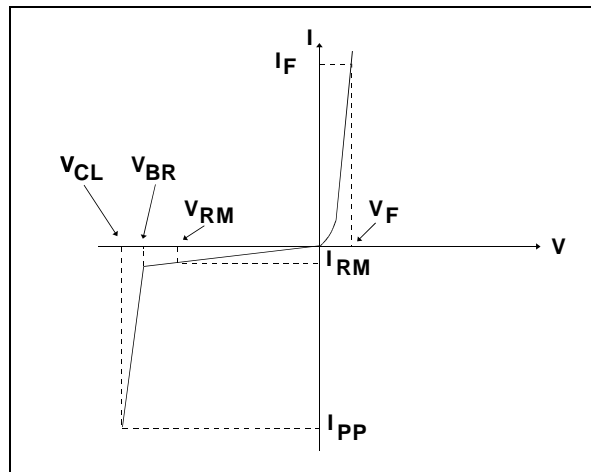

Types				I _{RM} @ V _{RM}		V _{BR} @ I _R		V _{CL} @ I _{PP}		V _{CL} @ I _{PP}		α _T	C
				max		min		max		max		max	typ
				μA		note2		10/1000μs		8/20μs		note3	note4
Unidirectional	Mark.	Bidirectional	Mark.	μA	V	V	mA	V	A	V	A	10 ⁻⁴ /°C	pF
SMAJ5.0A-TR	AE	SMAJ5.0CA-TR	AA	800	5.0	6.4	10	9.2	43.5	13.4	174	5.7	3500
SMAJ6.0A-TR	DUB	SMAJ6.0CA-TR	DBB	800	6.0	6.7	10	10.3	38.8	13.7	170	5.9	3300
SMAJ6.5A-TR	DUC	SMAJ6.5CA-TR	DBC	500	6.5	7.2	10	11.2	35.7	14.5	160	6.1	3100
SMAJ8.5A-TR	DUH	SMAJ8.5CA-TR	DBH	10	8.5	9.44	1	14.4	27.7	18.6	124	7.3	2000
SMAJ10A-TR	AX	SMAJ10CA-TR	AC	5	10	11.1	1	17	23.5	21.7	106	7.8	1550
SMAJ12A-TR	DUK	SMAJ12CA-TR	DBK	5	12	13.3	1	19.9	20.1	25.3	91	8.3	1325
SMAJ13A-TR	BG	SMAJ13CA-TR	BH	1	13	14.4	1	21.5	18.6	27.2	85	8.4	1200
SMAJ15A-TR	BM	SMAJ15CA-TR	AJ	1	15	16.7	1	24.4	16.4	32.5	71	8.8	975
SMAJ18A-TR	DUQ	SMAJ18CA-TR	DBQ	1	18	20	1	29.2	13.7	39.3	59	9.2	800
SMAJ20A-TR	DUR	SMAJ20CA-TR	DBR	1	20	22.2	1	32.4	12.3	42.8	54	9.4	725
SMAJ22A-TR	DUS	SMAJ22CA-TR	DBS	1	22	24.4	1	35.5	11.2	48.3	48	9.6	625
SMAJ24A-TR	DUT	SMAJ24CA-TR	DBT	1	24	26.7	1	38.9	10.3	50	46	9.6	600
SMAJ26A-TR	DUU	SMAJ26CA-TR	DBU	1	26	28.9	1	42.1	9.5	53.5	43	9.7	575
SMAJ28A-TR	CG	SMAJ28CA-TR	CH	1	28	31.1	1	45.4	8.8	59	39	9.8	510
SMAJ30A-TR	CK	SMAJ30CA-TR	CL	1	30	33.3	1	48.4	8.3	64.3	36	9.9	480
SMAJ33A-TR	CM	SMAJ33CA-TR	CN	1	33	36.7	1	53.3	7.5	69.7	33	10.0	450
SMAJ40A-TR	DUZ	SMAJ40CA-TR	DBZ	1	40	44.4	1	64.5	6.2	84	27	10.1	370
SMAJ43A-TR	EUA	SMAJ43CA-TR	EBA	1	43	47.8	1	69.4	5.7	91	25	10.2	350
SMAJ48A-TR	CX	SMAJ48CA-TR	CY	1	48	53.3	1	77.4	5.2	100	23	10.3	320
SMAJ58A-TR	EUF	SMAJ58CA-TR	EBF	1	58	64.4	1	93.6	4.3	121	19	10.4	270
SMAJ70A-TR	EUI	SMAJ70CA-TR	EBI	1	70	77.8	1	113	3.5	146	16	10.5	230
SMAJ85A-TR	EUL	SMAJ85CA-TR	EBL	1	85	94.4	1	137	2.9	178	13	10.6	200
SMAJ100A-TR	EUN	SMAJ100CA-TR	EBN	1	100	111	1	162	2.5	212	11	10.7	170
SMAJ130A-TR	EUQ	SMAJ130CA-TR	EBQ	1	130	144	1	209	1.9	265	9	10.8	145
SMAJ154A-TR	EUT	SMAJ154CA-TR	EBT	1	154	171	1	246	1.6	317	7	10.8	125
SMAJ170A-TR	SR	SMAJ170CA-TR	ESS	1	170	189	1	275	1.4	353	6.5	10.8	120
SMAJ188A-TR	EUV	SMAJ188CA-TR	EBV	1	188	209	1	328	1.4	388	6	10.8	110

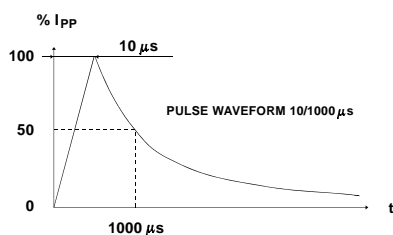

Note 2 : Pulse test : t_p < 50 ms.

Note 3 : ΔV_{BR} = α_T * (T_{amb} - 25) * V_{BR}(25°C).

Note 4 : V_R = 0 V, F = 1 MHz. For bidirectional types, capacitance value is divided by 2.

Fig 1: Peak power dissipation versus initial junction temperature.

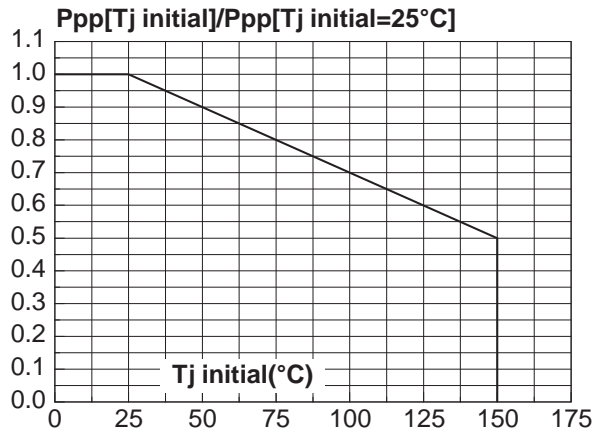

Fig 2: Peak pulse power versus exponential pulse duration ($T_j \text{ initial}=25^\circ\text{C}$).

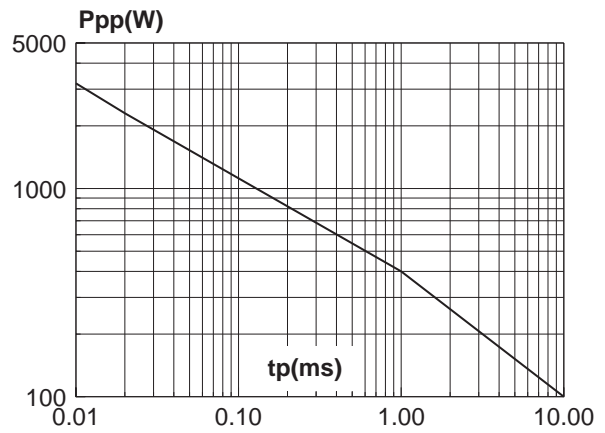

Fig 3: Clamping voltage versus peak pulse current ($T_j \text{ initial}=25^\circ\text{C}$)
Exponential waveform $t_p=20\mu\text{s}$ & $t_p=1\text{ms}$.

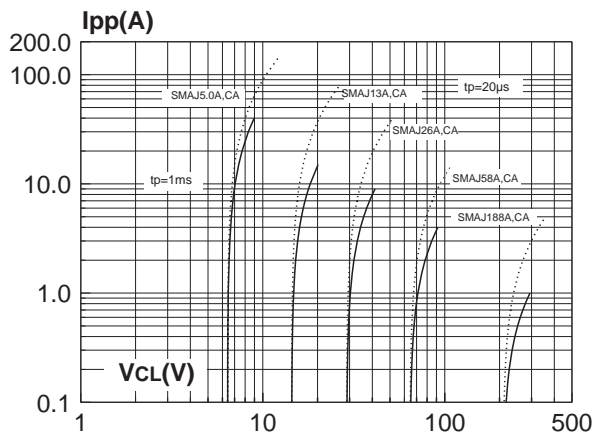

Fig 4-1: Capacitance versus reverse applied voltage (typical values) (SMAJxxA).

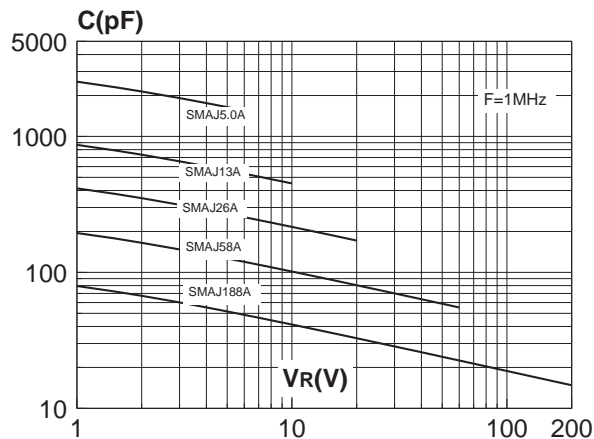
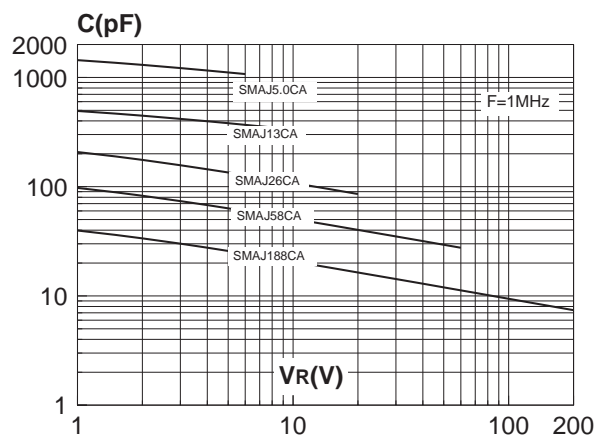

Fig 4-2: Capacitance versus reverse applied voltage (typical values) (SMAJxxCA).



SMAJxxxA-TR, CA-TR

Fig 5: Peak forward voltage drop versus peak forward current (typical values).

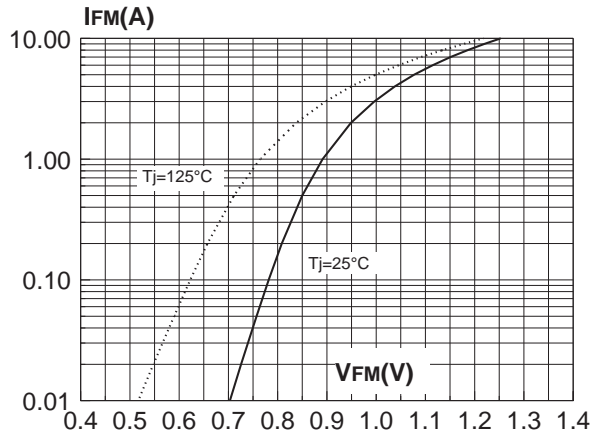

Fig 6: Relative variation of thermal impedance junction to ambient versus pulse duration.

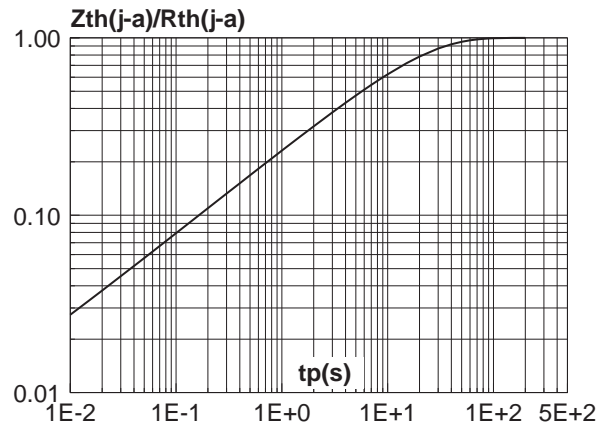

Fig 7: Thermal resistance junction to ambient versus copper surface under each lead (printed circuit board FR4 $\epsilon(\text{Cu})=35\mu\text{m}$).

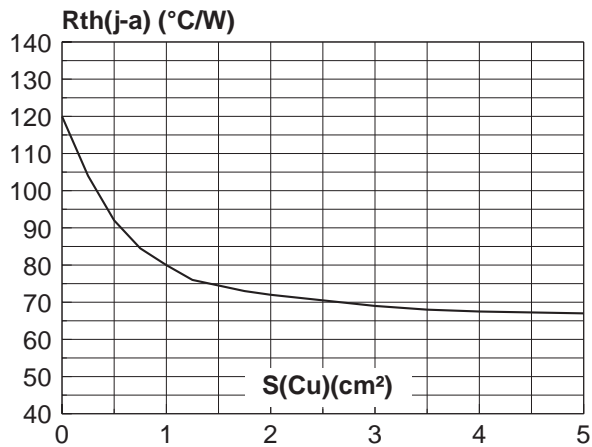
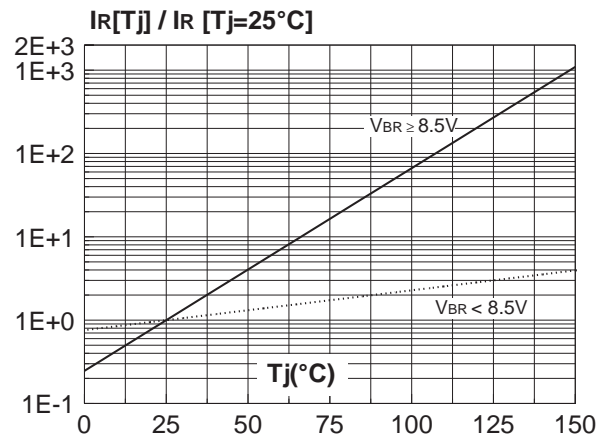
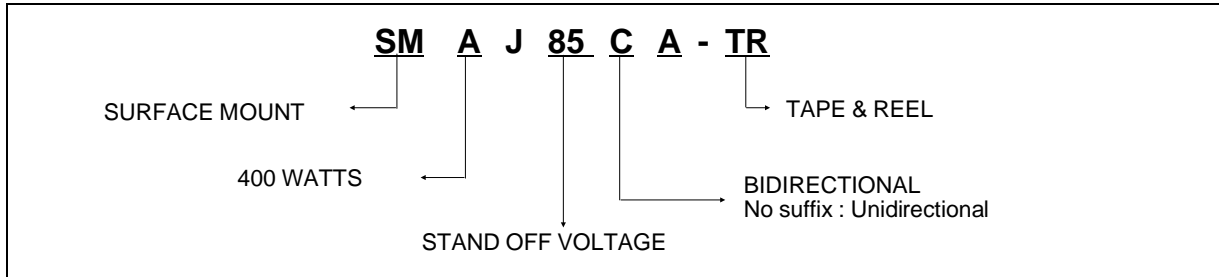

Fig 8: Relative variation of leakage current versus junction temperature.



ORDER CODE



MARKING : Logo, Date Code, Type Code, Cathode Band (for unidirectional types only).

PACKAGE MECHANICAL DATA

SMA (Plastic)

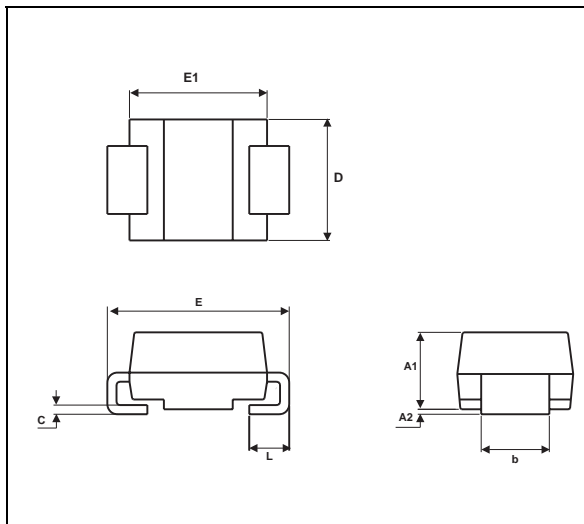

REF.	DIMENSIONS			
	Millimeters		Inches	
	Min.	Max.	Min.	Max.
A1	1.90	2.70	0.075	0.106
A2	0.05	0.20	0.002	0.008
b	1.25	1.65	0.049	0.065
c	0.15	0.41	0.006	0.016
E	4.80	5.60	0.189	0.220
E1	3.95	4.60	0.156	0.181
D	2.25	2.95	0.089	0.116
L	0.75	1.60	0.030	0.063

FOOTPRINT DIMENSIONS (Millimeter)

SMA Plastic.

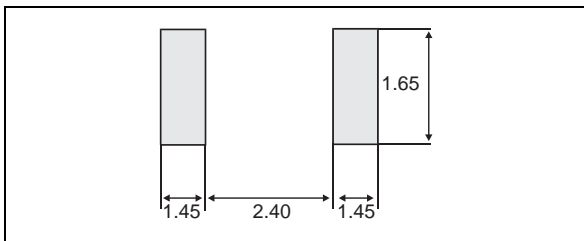

Weight = 0.068 g

Packaging : standard packaging is in tape and reel.

Information furnished is believed to be accurate and reliable. However, STMicroelectronics assumes no responsibility for the consequences of use of such information nor for any infringement of patents or other rights of third parties which may result from its use. No license is granted by implication or otherwise under any patent or patent rights of STMicroelectronics. Specifications mentioned in this publication are subject to change without notice. This publication supersedes and replaces all information previously supplied.

STMicroelectronics products are not authorized for use as critical components in life support devices or systems without express written approval of STMicroelectronics.

The ST logo is a registered trademark of STMicroelectronics

© 1998 STMicroelectronics - Printed in Italy - All rights reserved.

STMicroelectronics GROUP OF COMPANIES

Australia - Brazil - Canada - China - France - Germany - Italy - Japan - Korea - Malaysia - Malta - Mexico - Morocco - The Netherlands - Singapore - Spain - Sweden - Switzerland - Taiwan - Thailand - United Kingdom - U.S.A.