

MOSEL-VITELIC

V53C104A

急出货

PRELIMINARY

HIGH PERFORMANCE, LOW POWER
256K X 4 BIT FAST PAGE MODE
CMOS DYNAMIC RAM

HIGH PERFORMANCE V53C104A	70/70L	80/80L	10/10L
Max. RAS Access Time, (t_{RAC})	70 ns	80 ns	100 ns
Max. Column Address Access Time, (t_{CAA})	35 ns	40 ns	45 ns
Min. Fast Page Mode Cycle Time, (t_{PC})	45 ns	50 ns	55 ns
Min. Read/Write Cycle Time, (t_{RC})	130 ns	150 ns	180 ns

LOW POWER V53C104AL	70L	80L	10L
Max. CMOS Standby Current, (I_{DD6})	1.0 mA	1.0 mA	1.0 mA

Features

- 256K x 4 organization
- RAS access time: 70, 80, 100 ns
- Low power dissipation for V53C104A-10
 - Operating Current—65 mA max.
 - TTL Standby Current—2.0 mA max.
- Low CMOS Standby Current
 - V53C104A—1.5 mA max.
 - V53C104AL—1.0 mA max.
- Read-Modify-Write, RAS-Only Refresh, CAS-Before-RAS Refresh capability
- Common I/O
- 512 Refresh cycles/8 ms
- On-chip substrate bias generator
- Fast Page Mode for a sustained data rate greater than 22 MHz
- Standard packages are 20 pin Plastic DIP and 26/20 pin SOJ

high data bandwidth, fast usable speed, CMOS standby current and, on request, extended refresh for very low data retention power (V53C104AL).

All inputs and outputs are TTL compatible. Input and output capacitances are significantly lowered to allow increased system performance. Fast Page Mode operation allows random access of up to 512 (x4) bits within a row with cycle times as short as 45 ns. Because of static circuitry, the \overline{CAS} clock is not in the critical timing path. The flow-through column address latches allow address pipelining while relaxing many critical system timing requirements for fast usable speed. These features make the V53C104A ideally suited for graphics, digital signal processing and high performance computing systems.

Description

The V53C104A is a high speed 262144 x 4 bit CMOS dynamic random access memory. Fabricated with VICMOS III technology, the V53C104A offers a combination of features: Fast Page Mode for

The V53C104AL offers a maximum data retention power of 5.5 mW when operating in CMOS standby mode and performing RAS-only or CAS-before-RAS refresh cycles. For selected V53C104AL devices with Refresh Interval longer than 8 ms, consult factory.

Device Usage Chart

Operating Temperature Range	Package Outline		Access Time (ns)			Power		Temperature Mark
	P	K	70	80	100	Low	Std.	
0°C to 70°C	•	•	•	•	•	•	•	Blank

V53C104A Rev. 01 June 1990



MOSEL-VITELIC

V53C104A

Description	Pkg.	Pin Count
Plastic DIP	P	20
SOJ	K	26/20

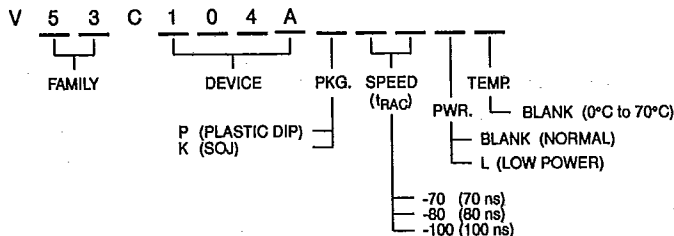

**26/20 Lead SOJ Package
PIN CONFIGURATION
Top View**

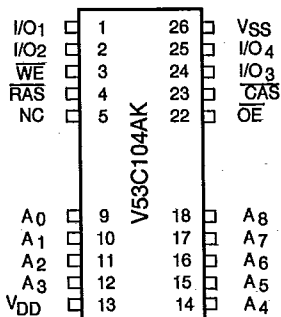

**20 Lead Plastic DIP
PIN CONFIGURATION
Top View**

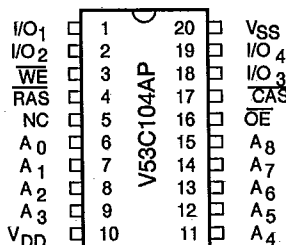

2

Pin Names

A ₀ -A ₈	Address Inputs
RAS	Row Address Strobe
CAS	Column Address Strobe
WE	Write Enable
OE	Output Enable
I/O ₁ -I/O ₄	Data Input, Output
V _{DD}	+5V Supply
V _{SS}	0V Supply
NC	No Connect

Absolute Maximum Ratings*

- Ambient Temperature
- Under Bias -10°C to +80°C
- Storage Temperature (plastic) -55°C to +125°C
- Voltage on any Pin Except V_{DD}
- Relative to V_{SS} -1.0 V to +7.0 V
- Voltage on V_{DD} relative to V_{SS} -1.0 V to +7.0 V
- Data Output Current 50 mA
- Power Dissipation 1.0 W

*Note: Operation above Absolute Maximum Ratings can adversely affect device reliability.

Capacitance*

T_A = 25°C, V_{DD} = 5 V ± 10%, V_{SS} = 0 V

Symbol	Parameter	Typ.	Max.	Unit
C _{IN1}	Address Input	3	4	pF
C _{IN2}	RAS, CAS, WE, OE	4	5	pF
C _{OUT}	Data Input/Output	5	7	pF

* Note: Capacitance is sampled and not 100% tested

MOSEL-VITELIC

V53C104A

DC and Operating Characteristics (1-2)

$T_A = 0^\circ\text{C}$ to 70°C , $V_{DD} = 5\text{ V} \pm 10\%$, $V_{SS} = 0\text{ V}$, unless otherwise specified.

Symbol	Parameter	Access Time	V53C104A		V53C104AL		Unit	Test Conditions	Notes
			Min.	Max.	Min.	Max.			
I_{LI}	Input Leakage Current (any input pin)		-10	10	-10	10	μA	$V_{SS} \leq V_{IN} \leq V_{DD}$	
I_{LO}	Output Leakage Current (for High-Z State)		-10	10	-10	10	μA	$V_{SS} \leq V_{OUT} \leq V_{DD}$ $\overline{\text{RAS}}, \overline{\text{CAS}}$ at V_{IH}	
I_{DD1}	V_{DD} Supply Current, Operating	70		85		85	mA	$t_{RC} = t_{RC}(\text{min.})$	1, 2
		80		75		75			
		100		65		65			
I_{DD2}	V_{DD} Supply Current, TTL Standby			2.0		2.0	mA	$\overline{\text{RAS}}, \overline{\text{CAS}}$ at V_{IH} other inputs $\geq V_{SS}$	
I_{DD3}	V_{DD} Supply Current, RAS-Only Refresh	70		85		85	mA	$t_{RC} = t_{RC}(\text{min.})$	2
		80		75		75			
		100		65		65			
I_{DD4}	V_{DD} Supply Current, Fast Page Mode Operation	70		65		65	mA	Minimum Cycle	1, 2
		80		55		55			
		100		50		50			
I_{DD5}	V_{DD} Supply Current, Standby, Output Enabled			3.0		2.0	mA	$\overline{\text{RAS}}=V_{IH}, \overline{\text{CAS}}=V_{IL}$ other inputs $\geq V_{SS}$	
I_{DD6}	V_{DD} Supply Current,			1.5		1.0	mA	$\overline{\text{RAS}} \geq V_{DD} - 0.2\text{ V}$, $\overline{\text{CAS}}$ at V_{IH} , all other inputs $\geq V_{SS}$	
V_{IL}	Input Low Voltage		-1.0	0.8	-1.0	0.8	V		3
V_{IH}	Input High Voltage		2.4	$V_{DD}+1$	2.4	$V_{DD}+1$	V		3
V_{OL}	Output Low Voltage			0.4		0.4	V	$I_{OL} = 4.2\text{ mA}$	
V_{OH}	Output High Voltage		2.4		2.4			$I_{OH} = -5\text{ mA}$	

MOSEL-VITELIC**V53C104A****AC Characteristics**

$T_A = 0^\circ\text{C}$ to 70°C , $V_{DD} = 5\text{ V} \pm 10\%$, $V_{SS} = 0\text{V}$ unless otherwise noted
 AC Test conditions, input pulse levels 0 to 3V

#	JEDEC Symbol	Symbol	Parameter	70/L		80/L		10/L		Unit	Notes
				Min.	Max.	Min.	Max.	Min.	Max.		
1	t_{RL1RH1}	t_{RAS}	$\overline{\text{RAS}}$ Pulse Width	70	75K	80	75K	100	75K	ns	
2	t_{RL2RL2}	t_{RC}	Read or Write Cycle Time	130		150		180		ns	
3	t_{RH2RL2}	t_{RP}	$\overline{\text{RAS}}$ Precharge Time	50		60		70		ns	
4	t_{RL1CH1}	t_{CSH}	$\overline{\text{CAS}}$ Hold Time	70		80		100		ns	
5	t_{CL1CH1}	t_{CAS}	$\overline{\text{CAS}}$ Pulse Width	20		20		25		ns	
6	t_{RL1CL1}	t_{RCD}	$\overline{\text{RAS}}$ to $\overline{\text{CAS}}$ Delay	20	50	20	60	25	75	ns	4
7	t_{WH2CL2}	t_{RCS}	Read Command Setup Time	0		0		0		ns	
8	t_{AVRL2}	t_{ASR}	Row Address Setup Time	0		0		0		ns	
9	t_{RL1AX}	t_{RAH}	Row Address Hold Time	10		10		15		ns	
10	t_{AVCL2}	t_{ASC}	Column Address Setup Time	0		0		0		ns	
11	t_{CL1AX}	t_{CAH}	Column Address Hold Time	15		15		20		ns	
12	$t_{CL1RH1(R)}$	$t_{RSH(R)}$	$\overline{\text{RAS}}$ Hold Time (Read Cycle)	20		20		25		ns	
13	t_{CH2RL2}	t_{CRP}	$\overline{\text{CAS}}$ to $\overline{\text{RAS}}$ Precharge Time	5		5		10		ns	
14	t_{CH2WX}	t_{RCH}	Read Command Hold Time Referenced to $\overline{\text{CAS}}$	0		0		0		ns	5
15	t_{RH2WX}	t_{RRH}	Read Command Hold Time Referenced to $\overline{\text{RAS}}$	0		0		0		ns	5
16	$t_{OEL1RH2}$	t_{ROH}	$\overline{\text{RAS}}$ Hold Time Referenced to $\overline{\text{OE}}$	10		10		10		ns	
17	t_{GL1QV}	t_{OAC}	Access Time from $\overline{\text{OE}}$		20		20		25	ns	
18	t_{CL1QV}	t_{OAC}	Access Time from $\overline{\text{CAS}}$		20		20		25	ns	6,7
19	t_{RL1QV}	t_{RAC}	Access Time from $\overline{\text{RAS}}$		70		80		100	ns	6,8,9
20	t_{AVQV}	t_{CAA}	Access Time from Column Address		35		40		45	ns	6,7, 10

MOSEL-VITELIC

V53C104A

AC Characteristics (Cont'd.)

#	JEDEC Symbol	Symbol	Parameter	70/L		80/L		10/L		Unit	Notes
				Min.	Max.	Min.	Max.	Min.	Max.		
21	t_{CL10X}	t_{LZ}	\overline{OE} or \overline{CAS} to Low-Z Output	0		0		0		ns	16
22	t_{CH2QZ}	t_{HZ}	\overline{OE} or \overline{CAS} to High-Z Output	0	20	0	20	0	20	ns	16
23	t_{RL1AX}	t_{AR}	Column Address Hold Time from \overline{RAS}	55		60		75		ns	
24	t_{RL1AV}	t_{RAD}	\overline{RAS} to Column Address Delay Time	15	35	15	40	20	55	ns	11
25	$t_{CL1RH1(W)}$	$t_{RSH(W)}$	\overline{RAS} or \overline{CAS} Hold Time in Write Cycle	20		20		25		ns	
26	t_{WL1CH1}	t_{CWL}	Write Command to \overline{CAS} Lead Time	20		20		25		ns	
27	t_{WL1CL2}	t_{WCS}	Write Command Setup Time	0		0		0		ns	12,13
28	t_{CL1WH1}	t_{WCH}	Write Command Hold Time	15		15		20		ns	
29	t_{WL1WH1}	t_{WP}	Write Pulse Width	15		15		20		ns	
30	t_{RL1WH1}	t_{WCR}	Write Command Hold Time from \overline{RAS}	55		60		75		ns	
31	t_{WL1RH1}	t_{RWL}	Write Command to \overline{RAS} Lead Time	20		20		25		ns	
32	t_{DVWL2}	t_{DS}	Data in Setup Time	0		0		0		ns	14
33	t_{WL1DX}	t_{DH}	Data in Hold Time	15		15		20		ns	14
34	t_{WL1GL2}	t_{WOH}	Write to \overline{OE} Hold Time	20		20		25		ns	14
35	t_{GH2DX}	t_{OED}	\overline{OE} to Data Delay Time	20		20		25		ns	14
36	$t_{RL2RL2(RMW)}$	t_{RWC}	Read-Modify-Write Cycle Time	185		205		245		ns	
37	$t_{RL1RH1(RMW)}$	t_{RRW}	Read-Modify-Write Cycle \overline{RAS} Pulse Width	125		135		165		ns	
38	t_{CL1WL2}	t_{CWD}	\overline{CAS} to \overline{WE} Delay	50		50		60		ns	12

MOSEL-VITELIC

V53C104A

AC Characteristics (Cont'd.)

#	JEDEC Symbol	Symbol	Parameter	70/L		80/L		10/L		Unit	Notes
				Min.	Max.	Min.	Max.	Min.	Max.		
39	t_{RL1WL2}	t_{RWD}	\overline{RAS} to \overline{WE} Delay in Read-Modify-Write Cycle	100		110		135		ns	12
40	t_{CL1CH1}	t_{CRW}	\overline{CAS} Pulse Width (RMW)	75		75		90		ns	
41	t_{AVWL2}	t_{AWD}	Col. Address to \overline{WE} Delay	65		70		80		ns	12
42	t_{CL2CL2}	t_{PC}	Fast Page Mode Read or Write Cycle Time	45		50		55		ns	
43	t_{CH2CL2}	t_{CP}	\overline{CAS} Precharge Time	10		10		10		ns	
44	t_{AVRH1}	t_{OAR}	Column Address to \overline{RAS} Setup Time	35		40		45		ns	
45	t_{CH2QV}	t_{CAP}	Access Time from Column Precharge		40		45		50	ns	7
46	t_{RL1DX}	t_{DHR}	Data in Hold Time Referenced to \overline{RAS}	55		60		75		ns	
47	t_{CL1RL2}	t_{CSR}	\overline{CAS} Setup Time \overline{CAS} -before- \overline{RAS} Refresh	10		10		10		ns	
48	t_{RH2CL2}	t_{RPC}	\overline{RAS} to \overline{CAS} Precharge Time	10		10		10		ns	
49	t_{RL1CH1}	t_{CHR}	\overline{CAS} Hold Time \overline{CAS} -before- \overline{RAS} Refresh	30		30		30		ns	
50	t_{CL2CL2} (RMW)	t_{PCM}	Fast Page Mode Read-Modify-Write Cycle Time	95		100		115		ns	
	t_T	t_T	Transition Time (Rise and Fall)	3	50	3	50	3	50	ns	15
		t_{RI}	Refresh Interval (512 Cycles)		8		8		8	ms	17

MOSEL-VITELIC**V53C104A****Notes:**

1. I_{DD} is dependent on output loading when the device output is selected. Specified I_{DD} (max.) is measured with the output open.
2. I_{DD} is dependent upon the number of address transitions. Specified I_{DD} (max.) is measured with a maximum of two transitions per address cycle in Fast Page Mode.
3. Specified V_{IL} (min.) is steady state operating. During transitions, V_{IL} (min.) may undershoot to -1.0 V for a period not to exceed 20 ns. All AC parameters are measured with V_{IL} (min.) $\geq V_{SS}$ and V_{IH} (max.) $\leq V_{DD}$.
4. t_{RCD} (max.) is specified for reference only. Operation within t_{RCD} (max.) limits insures that t_{RAC} (max.) and t_{CAA} (max.) can be met. If t_{RCD} is greater than the specified t_{RCD} (max.), the access time is controlled by t_{CAA} and t_{CAC} .
5. Either t_{RRH} or t_{RCH} must be satisfied for a Read Cycle to occur.
6. Measured with a load equivalent to two TTL inputs and 100 pF.
7. Access time is determined by the longest of t_{CAA} , t_{CAC} and t_{CAP} .
8. Assumes that $t_{RAD} \leq t_{RAD}$ (max.). If t_{RAD} is greater than t_{RAD} (max.), t_{RAC} will increase by the amount that t_{RAD} exceeds t_{RAD} (max.).
9. Assumes that $t_{RCD} \leq t_{RCD}$ (max.). If t_{RCD} is greater than t_{RCD} (max.), t_{RAC} will increase by the amount that t_{RCD} exceeds t_{RCD} (max.).
10. Assumes that $t_{RAD} \geq t_{RAD}$ (max.).
11. Operation within the t_{RAD} (max.) limit ensures that t_{RAC} (max.) can be met. t_{RAD} (max.) is specified as a reference point only. If t_{RAD} is greater than the specified t_{RAD} (max.) limit, the access time is controlled by t_{CAA} and t_{CAC} .
12. t_{WCS} , t_{RWD} , t_{AWD} and t_{CWD} are not restrictive operating parameters.
13. t_{WCS} (min.) must be satisfied in an Early Write Cycle.
14. t_{DS} and t_{DH} are referenced to the latter occurrence of \overline{CAS} or \overline{WE} .
15. t_T is measured between V_{IH} (min.) and V_{IL} (max.). AC-measurements assume $t_T = 5$ ns.
16. Assumes a three-state test load (5 pF and a 380 Ohm Thevenin equivalent).
17. An initial 200 μ s pause and 8 \overline{RAS} -containing cycles are required when exiting an extended period of bias without clocks. An extended period of time without clocks is defined as one that exceeds the specified Refresh Interval.

MOSEL-VITELIC

V53C104A

Waveforms of OE-Controlled Write Cycle

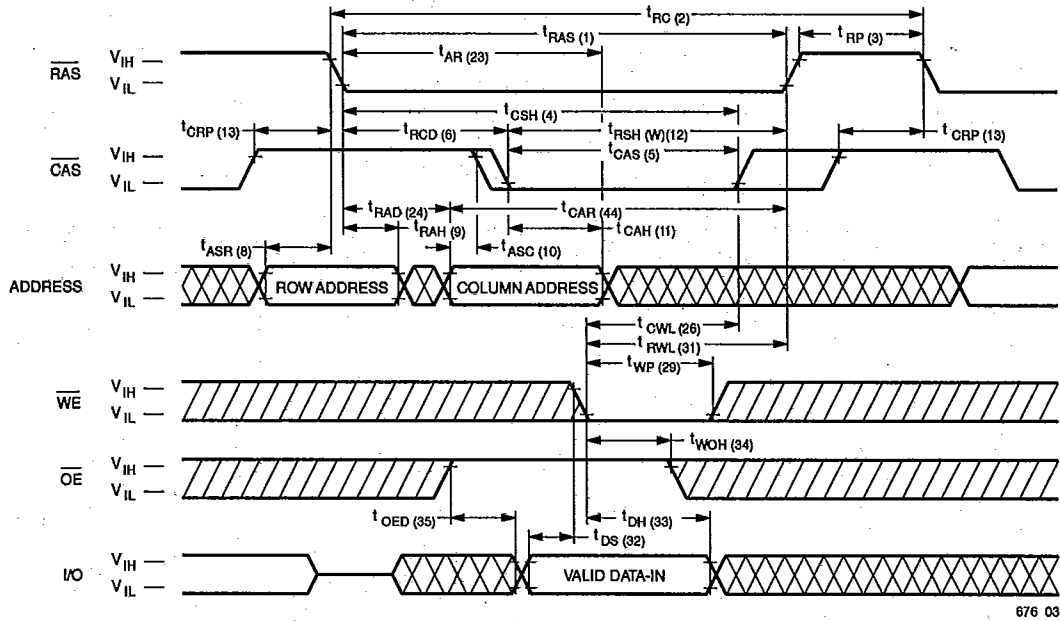

2

676 03

Waveforms of Read-Modify-Write Cycle

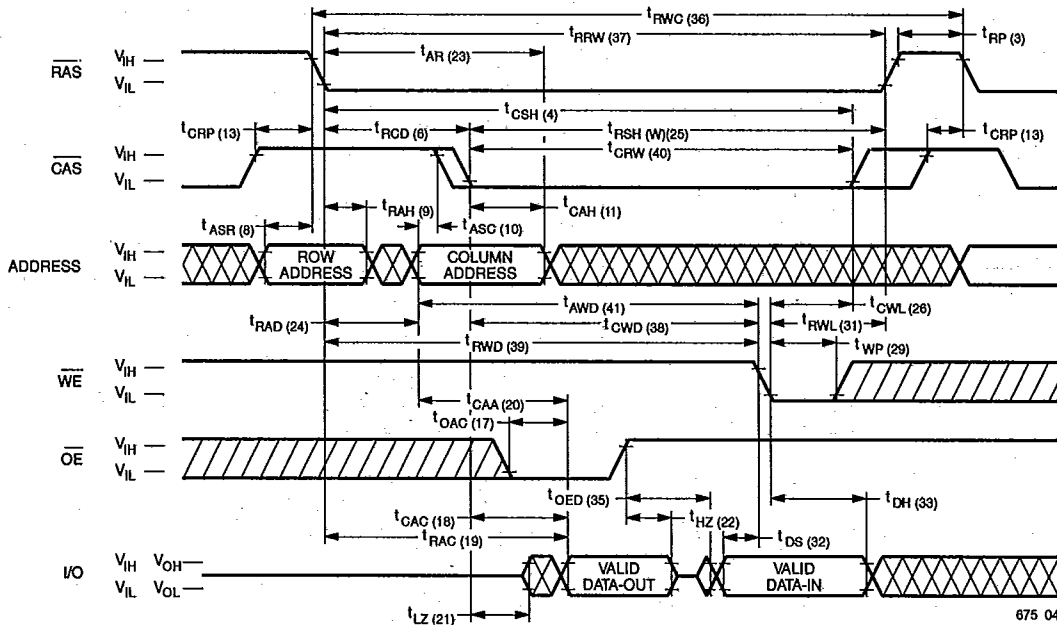

675 04

MOSEL-VITELIC

V53C104A

Waveforms of CAS-before-RAS Refresh Cycle

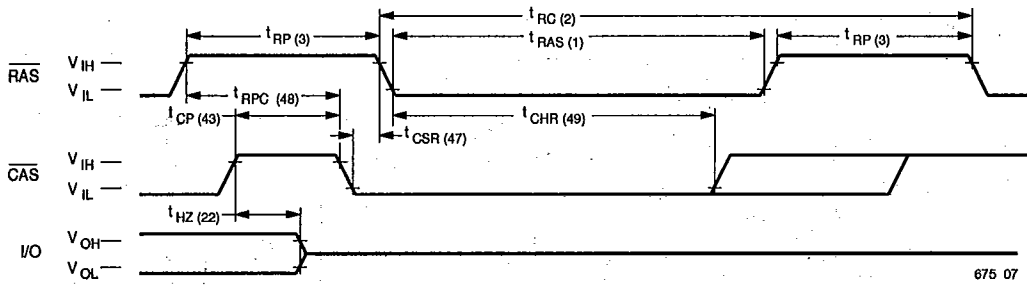

NOTE: \overline{WE} , \overline{OE} , A_0-A_7 = Don't care

Waveforms of Hidden Refresh Cycle (Read)

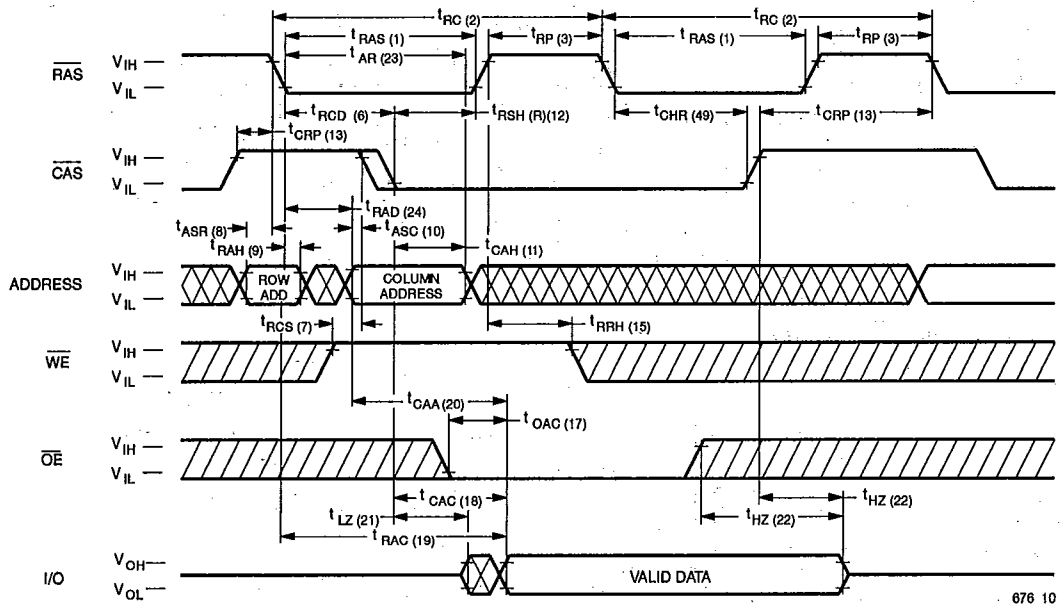

Waveforms of Hidden Refresh Cycle (Write)

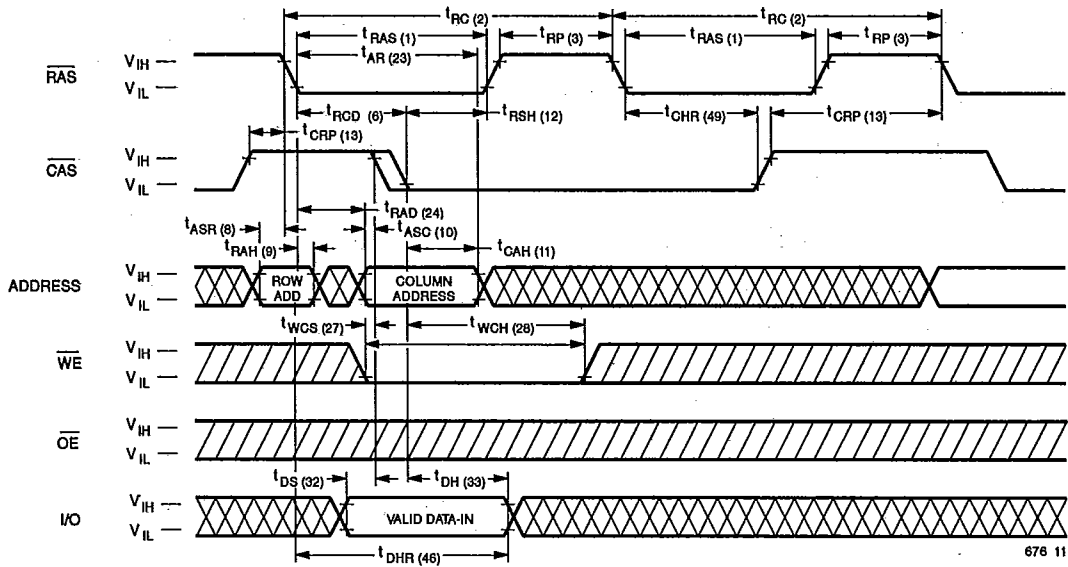

MOSEL-VITELIC

V53C104A

Waveforms of $\overline{\text{CAS}}$ -before- $\overline{\text{RAS}}$ Refresh Counter Test Cycle

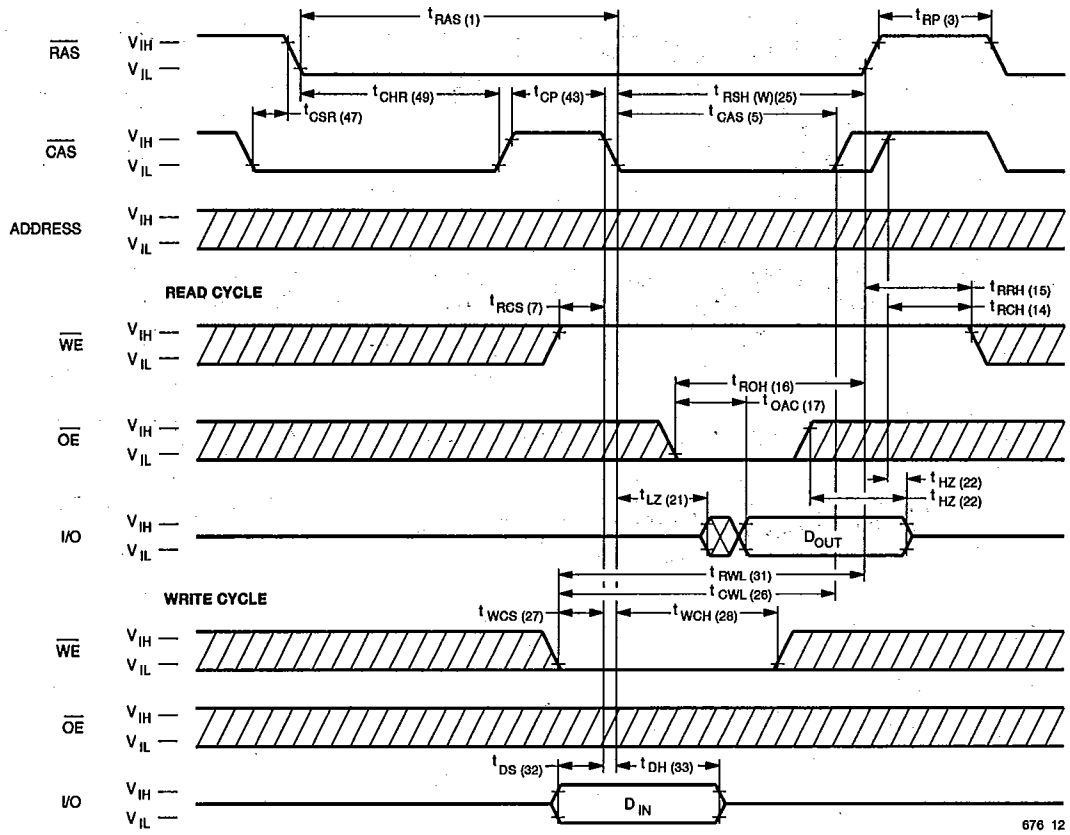

MOSEL-VITELIC**V53C104A****Functional Description**

The V53C104A is a CMOS dynamic RAM optimized for high data bandwidth, low power applications. It is functionally similar to a traditional dynamic RAM. The V53C104A reads and writes data by multiplexing an 18-bit address into a 9-bit row and a 9-bit column address. The row address is latched by the Row Address Strobe ($\overline{\text{RAS}}$). The column address "flows through" an internal address buffer and is latched by the Column Address Strobe ($\overline{\text{CAS}}$). Because access time is primarily dependent on a valid column address rather than the precise time that the $\overline{\text{CAS}}$ edge occurs, the delay time from $\overline{\text{RAS}}$ to $\overline{\text{CAS}}$ has little effect on the access time.

Memory Cycle

A memory cycle is initiated by bringing $\overline{\text{RAS}}$ low. Any memory cycle, once initiated, must not be ended or aborted before the minimum t_{RAS} time has expired. This ensures proper device operation and data integrity. A new cycle must not be initiated until the minimum precharge time $t_{\text{RP}}/t_{\text{CP}}$ has elapsed.

Read Cycle

A Read cycle is performed by holding the Write Enable ($\overline{\text{WE}}$) signal High during a $\overline{\text{RAS}}/\overline{\text{CAS}}$ operation. The column address must be held for a minimum specified by t_{AR} . Data Out becomes valid only when t_{OAC} , t_{RAC} , t_{CAA} and t_{CAC} are all satisfied. As a result, the access time is dependent on the timing relationships between these parameters. For example, the access time is limited by t_{CAA} when t_{RAC} , t_{CAC} and t_{OAC} are all satisfied.

Write Cycle

A Write Cycle is performed by taking $\overline{\text{WE}}$ and $\overline{\text{CAS}}$ low during a $\overline{\text{RAS}}$ operation. The column address is latched by $\overline{\text{CAS}}$. The Write Cycle can be $\overline{\text{WE}}$ controlled or $\overline{\text{CAS}}$ controlled depending on whether $\overline{\text{WE}}$ or $\overline{\text{CAS}}$ falls later. Consequently, the input data must be valid at or before the falling edge of $\overline{\text{WE}}$ or $\overline{\text{CAS}}$, whichever occurs last. In the $\overline{\text{CAS}}$ -controlled Write Cycle, when the leading edge of $\overline{\text{WE}}$ occurs prior to the $\overline{\text{CAS}}$ low transition, the I/O data pins will be in the High-Z state at the beginning of the Write function.

Ending the Write with $\overline{\text{RAS}}$ or $\overline{\text{CAS}}$ will maintain the output in the High-Z state.

In the $\overline{\text{WE}}$ controlled Write Cycle, $\overline{\text{OE}}$ must be in the high state and t_{OED} must be satisfied.

Refresh Cycle

To retain data, 512 Refresh Cycles are required in each 8 ms period. There are two ways to refresh the memory:

1. By clocking each of the 512 row addresses (A_0 through A_9) with $\overline{\text{RAS}}$ at least once every 8 ms. Any Read, Write, Read-Modify-Write or $\overline{\text{RAS}}$ -only cycle refreshes the addressed row.
2. Using a $\overline{\text{CAS}}$ -before- $\overline{\text{RAS}}$ Refresh Cycle. If $\overline{\text{CAS}}$ makes a transition from low to high to low after the previous cycle and before $\overline{\text{RAS}}$ falls, $\overline{\text{CAS}}$ -before- $\overline{\text{RAS}}$ refresh is activated. The V53C104A uses the output of an internal 9-bit counter as the source of row addresses and ignore external address inputs.

$\overline{\text{CAS}}$ -before- $\overline{\text{RAS}}$ is a "refresh-only" mode and no data access or device selection is allowed. Thus, the output remains in the High-Z state during the cycle. A $\overline{\text{CAS}}$ -before- $\overline{\text{RAS}}$ counter test mode is provided to ensure reliable operation of the internal refresh counter.

Data Retention Mode

The V53C104A offers a CMOS standby mode that is entered by causing the $\overline{\text{RAS}}$ clock to swing between a valid V_{IL} and an "extra high" V_{IH} within 0.2 V of V_{DD} . While the $\overline{\text{RAS}}$ clock is at the "extra high" level, the V53C104A power consumption is reduced to the low I_{DD6} level. Overall I_{DD} consumption when operating in this mode can be calculated as follows:

$$I = \frac{(t_{\text{RC}}) \times (I_{\text{DD1}}) + (t_{\text{RX}} - t_{\text{RC}}) \times (I_{\text{DD6}})}{t_{\text{RX}}}$$

Where: t_{RC} = Refresh Cycle Time
 t_{RX} = Refresh Interval / 512

MOSEL-VITELIC**V53C104A****Fast Page Mode Operation**

Fast Page Mode operation permits all 512 columns within a selected row of the device to be randomly accessed at a high data rate. Maintaining $\overline{\text{RAS}}$ low while performing successive CAS cycles retains the row address internally and eliminates the need to reapply it for each cycle. The column address buffer acts as a transparent or flow-through latch while CAS is high. Thus, access begins from the occurrence of a valid column address rather than from the falling edge of $\overline{\text{CAS}}$, eliminating t_{ASC} and t_{T} from the critical timing path. CAS latches the address into the column address buffer and acts as an output enable. During Fast Page Mode operation, Read, Write, Read-Modify-Write or Read-Write-Read cycles are possible at random addresses within a row. Following the initial entry cycle into Fast Page Mode, access is t_{CAA} or t_{CAP} controlled. If the column address is valid prior to the rising edge of CAS, the access time is referenced to the CAS rising edge and is specified by t_{CAP} . If the column address is valid after the rising CAS edge, access is timed from the occurrence of a valid address and is specified by t_{CAA} . In both cases, the falling edge of CAS latches the address and enables the output.

Fast Page Mode provides a sustained data rate of over 22MHz for applications that require high data rates such as bit-mapped graphics or high-speed signal processing. The following equation can be used to calculate the maximum data rate:

$$\text{Data Rate} = \frac{512}{t_{\text{RC}} + 511 \times t_{\text{PC}}}$$

Data Output Operation

The V53C104A Input/Output is controlled by $\overline{\text{OE}}$, $\overline{\text{CAS}}$, $\overline{\text{WE}}$ and $\overline{\text{RAS}}$. A $\overline{\text{RAS}}$ low transition enables the transfer of data to and from the selected row address in the Memory Array. A $\overline{\text{RAS}}$ high transition disables data transfer and latches the output data if the output is enabled. After a memory cycle is initiated with a $\overline{\text{RAS}}$ low transition, a CAS low transition or $\overline{\text{CAS}}$ low level enables the internal I/O path. A CAS high transition or a $\overline{\text{CAS}}$ high level disables the I/O path and the output driver if it is enabled. A CAS low transition while $\overline{\text{RAS}}$ is high has no effect on the I/O data path or on the output drivers. The output drivers, when otherwise enabled, can be disabled by holding

$\overline{\text{OE}}$ high. The $\overline{\text{OE}}$ signal has no effect on any data stored in the output latches. A $\overline{\text{WE}}$ low level can also disable the output drivers when $\overline{\text{CAS}}$ is low. During a Write cycle, if $\overline{\text{WE}}$ goes low at a time in relationship to CAS that would normally cause the outputs to be active, it is necessary to use $\overline{\text{OE}}$ to disable the output drivers prior to the $\overline{\text{WE}}$ low transition to allow Data In Setup Time (t_{DS}) to be satisfied.

Power-On

After application of the V_{DD} supply, an initial pause of 200 μs is required followed by a minimum of 8 initialization cycles (any combination of cycles containing a $\overline{\text{RAS}}$ clock). Eight initialization cycles are required after extended periods of bias without clocks (greater than the Refresh Interval).

During power on, the V_{DD} current requirement of the V53C104A is dependent on the input levels of $\overline{\text{RAS}}$ and CAS. If $\overline{\text{RAS}}$ is low during Power-On, the device will go into an active cycle and I_{DD} will exhibit current transients. It is recommended that $\overline{\text{RAS}}$ and $\overline{\text{CAS}}$ track with V_{DD} or be held at a valid V_{IH} during Power-On to avoid current surges.

Table 1. V53C104A Data Output Operation for Various Cycle Types

Cycle Type	I/O State
Read Cycles	Data from Addressed Memory Cell
CAS-Controlled Write Cycle (Early Write)	High-Z
$\overline{\text{WE}}$ -Controlled Write Cycle (Late Write)	$\overline{\text{OE}}$ Controlled. High $\overline{\text{OE}}$ = High-Z I/Os
Read-Modify-Write Cycles	Data from Addressed Memory Cell
Fast Page Mode Read	Data from Addressed Memory Cell
Fast Page Mode Write Cycle (Early Write)	High-Z
Fast Page Mode Read-Modify-Write Cycle	Data from Addressed Memory Cell
$\overline{\text{RAS}}$ -only Refresh	High-Z
$\overline{\text{CAS}}$ -before- $\overline{\text{RAS}}$ Refresh Cycle	Data remains as in previous cycle
CAS-only Cycles	High-Z