

THYRISTOR MODULE

AK55HB120/160

UL;E76102 (M)

Power Thyristor Module AK55HB series are designed for various rectifier circuits and power controls. For your circuit application, following internal connections and wide voltage ratings up to 1600V are available, and electrically isolated mounting base make your mechanical design easy.

Isolated mounting base

- $I_{T(AV)}$ 55A, $I_{T(RMS)}$ 122A, I_{TSM} 1100A
- di/dt 150 A/ μ s
- dv/dt 500V/ μ s

(Applications)

- AC/DC motor drives
- Heater controls
- Light dimmers
- Static switches

Internal Configurations

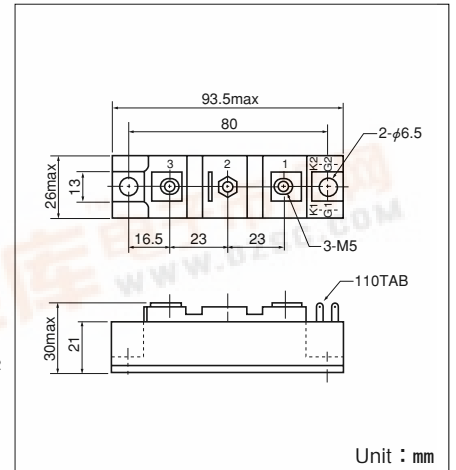
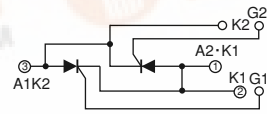

Maximum Ratings

($T_j=25^\circ\text{C}$ unless otherwise specified)

Symbol	Item	Ratings		Unit
		AK55HB120	AK55HB160	
V _{DRM}	Repetitive Peak Off-State Voltage	1200	1600	V

Symbol	Item	Conditions	Ratings	Unit	
$I_{T(AV)}$	Average On-State Current	Single phase, half wave, 180° conduction, $T_c : 85^\circ\text{C}$	55	A	
$I_{T(RMS)}$	R.M.S. On-State Current	$T_c : 85^\circ\text{C}$	122	A	
I_{TSM}	Surge On-State Current	1/2 cycle, 50Hz/60Hz, peak value, non-repetitive	1000/1100	A	
I^2t	I^2t	Value for one cycle of surge current	5000	A ² S	
P _{GM}	Peak Gate Power Dissipation		10	W	
P _{G(AV)}	Average Gate Power Dissipation		3	W	
I _{FGM}	Peak Gate Current		3	A	
V _{FGM}	Peak Gate Voltage (Forward)		10	V	
V _{VRGM}	Peak Gate Voltage (Reverse)		5	V	
di/dt	Critical Rate of Rise of On-State Current	$I_G=100\text{mA}$, $T_j=25^\circ\text{C}$, $V_D=1/2V_{DRM}$, $dI_G/dt=0.1\text{A}/\mu\text{s}$	150	A/ μ s	
V _{ISO}	Isolation Breakdown Voltage (R.M.S.)	A.C. 1 minute	2500	V	
T _j	Operating Junction Temperature		-40 to +125	°C	
T _{stg}	Storage Temperature		-40 to +125	°C	
	Mounting Torque	Mounting (M6)	Recommended Value 2.5-3.9 (25-40)	4.7 (48)	N·m (kgf·cm)
		Terminal (M5)	Recommended Value 1.5-2.5 (15-25)	2.7 (28)	
	Mass	Typical Value	170	g	

Electrical Characteristics

Symbol	Item	Conditions	Ratings	Unit
I _{DRM}	Repetitive Peak Off-State Current, max.	at V _{DRM} , Single phase, half wave, $T_j=125^\circ\text{C}$	20	mA
V _{TM}	Peak On-State Voltage max.	On-State Current 165A, $T_j=125^\circ\text{C}$ Inst. measurement	1.50	V
I _{GT} /V _{GT}	Gate Trigger Current/Voltage, max.	$T_j=25^\circ\text{C}$, $I_T=1\text{A}$, $V_D=6\text{V}$	100/2	mA/V
V _{GD}	Non-Trigger Gate, Voltage, min.	$T_j=125^\circ\text{C}$, $V_D=1/2V_{DRM}$	0.25	V
t _{gt}	Turn On Time, max.	$I_T=55\text{A}$, $I_G=100\text{mA}$, $T_j=25^\circ\text{C}$, $V_D=1/2V_{DRM}$, $dI_G/dt=0.1\text{A}/\mu\text{s}$	10	μ s
dv/dt	Critical Rate of Rise of Off-State Voltage, min.	$T_j=125^\circ\text{C}$, $V_D=2/3V_{DRM}$, Exponential wave.	500	V/ μ s
I _H	Holding Current, typ.	$T_j=25^\circ\text{C}$	50	mA
I _L	Latching Current, typ.	$T_j=25^\circ\text{C}$	100	mA
R _{th(j-c)}	Thermal Impedance, max.	Junction to case, per 1/2 Module	0.50	°C/W
		Junction to case, per 1 Module	0.25	



Gate Characteristics

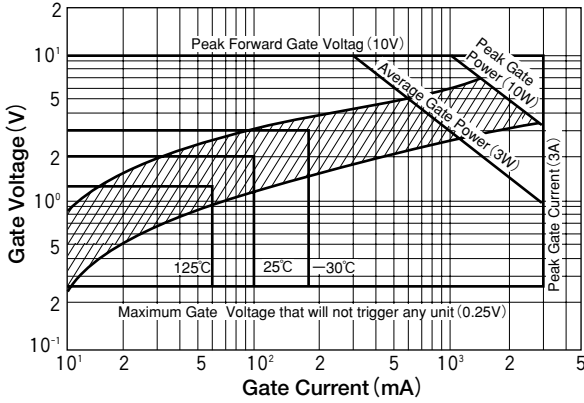

On-State Voltage max

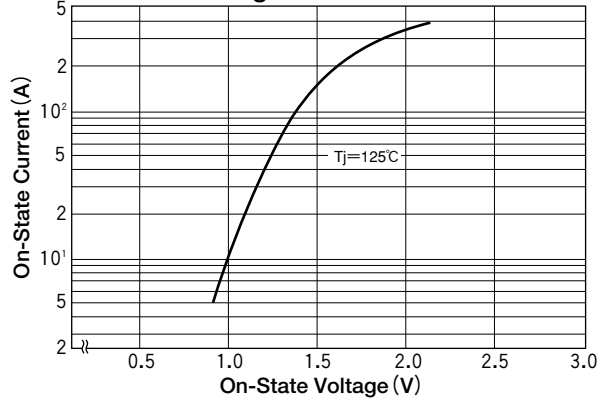

Average On-State Current Vs Power Dissipation (Single phase half wave)

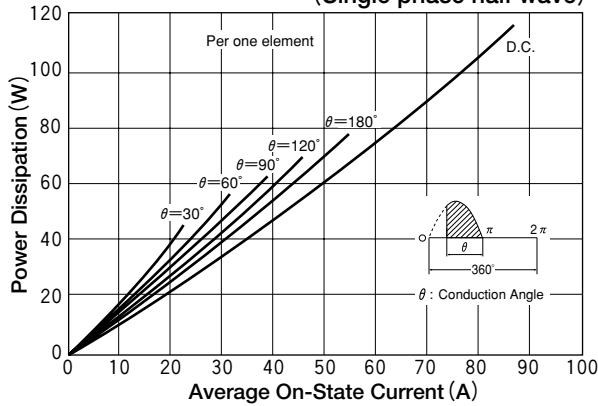

Average On-State Current Vs Maximum Allowable Case Temperature (Single phase half wave)

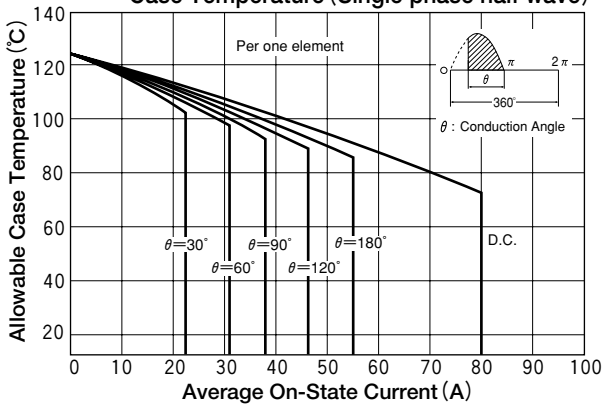

Surge On-State Current Rating (Non-Repetitive)

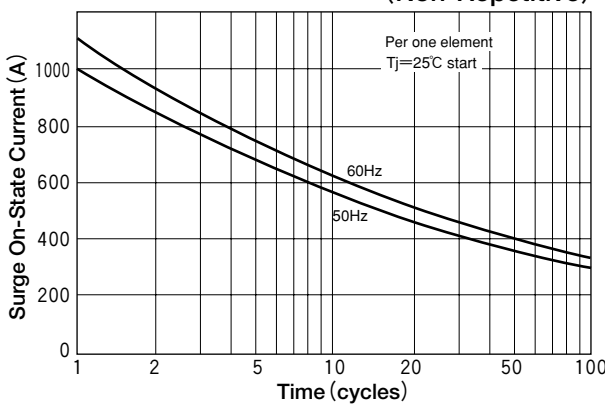

Transient Thermal Impedance

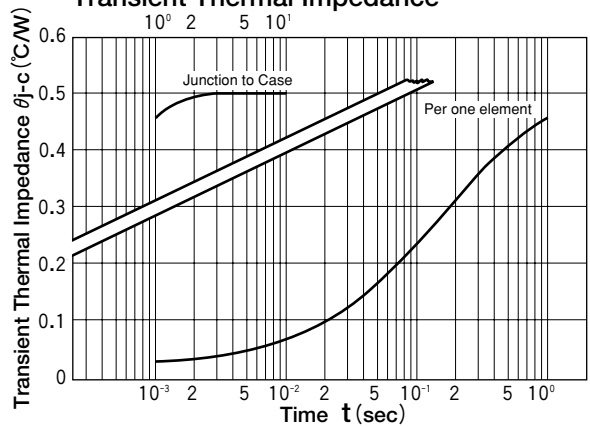

Output Current W1; Bidirectional connection

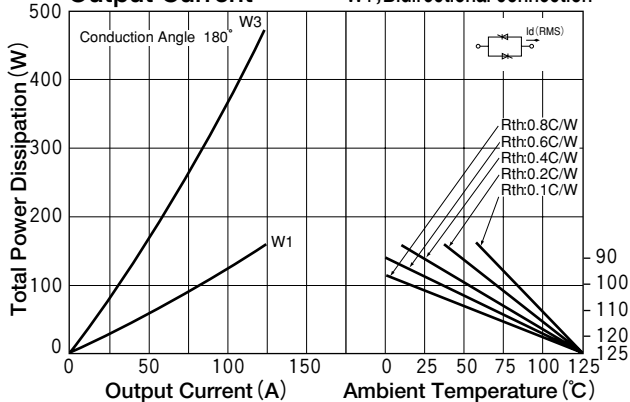

W3; Three phase bidirectional connection

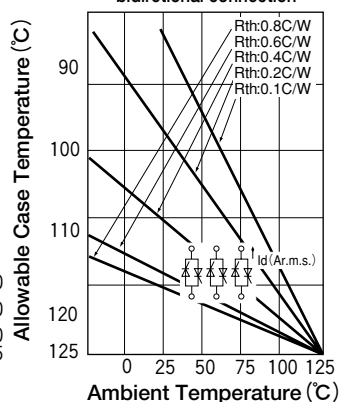

RMS On-State Current Vs Allowable Case Temperature

