



High Intercept Amplifier, 15 - 100 MHz

V 2.00

AM05-0006

Features

- Gain: 10.1 dB Nominal
- IP3 of +43 dBm Typical
- Land Grid Array (LGA) Package
- Compression point of +27 dBm Typical
- 50 ohm impedance
- Test boards are available
- Tape and Reel Packaging Available

Description

M/A-COM's AM05-0006 is a coupler feedback amplifier with high intercept and compression points. This device is in a ceramic land grid array package. This package is designed for standard surface mount pick and place. Due to the ceramic package the thermal rise minimized. The ground plane on the PC board should be configured to remove heat from under the package. AM05-0006 is ideally suited for use where a high intercept commercial amplifier is required at a low cost.

LGA-1

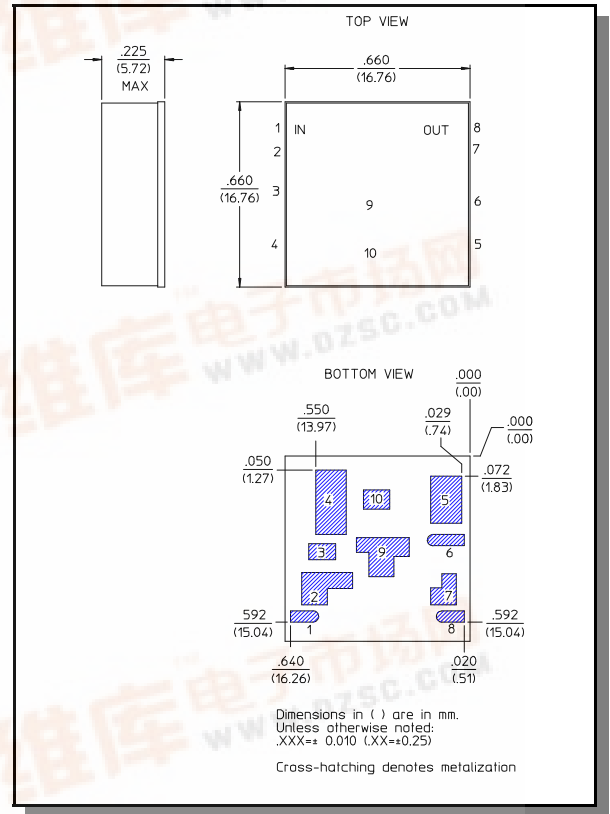

Electrical Specifications: $T_A = 25^\circ\text{C}$

Parameter	Test Conditions	Frequency	Units	Min.	Typ.	Max.
Gain	—	50 MHz	dB	9.6	10.1	10.6
Gain Flatness	—	15 - 100 MHz	dB	—	± 0.2	± 0.4
VSWR	—	15 - 100 MHz	Ratio	—	1.4:1	1.8:1
1 dB Compression	Output Power	15 - 100 MHz	dBm	23	27	—
Output IP ₂	Two-tone inputs up to +10 dBm	15 - 100 MHz	dBm	55	65	—
Output IP ₃	Two-tone inputs up to +10 dBm	15 - 100 MHz	dBm	40	46	—
Noise Figure	—	15 - 100 MHz	dB	—	3.0	5.0
Reverse Transmission	—	15 - 100 MHz	dB	—	-14	-13
+V	—	—	V	11.4	12.0	12.6
Ibias	1.1W Typical	—	mA	—	88	120

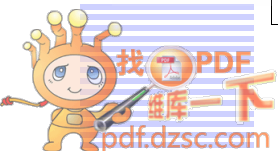

Absolute Maximum Ratings ¹

Parameter	Absolute Maximum
Max Input Power	+15 dBm
V _{bias}	-0.5 to +14.0 V
Operating Temperature	-40°C to +85°C
Storage Temperature	-65°C to +125°C

1. Operation of this device above any one of these parameters may cause permanent damage.

Pin Configuration

Pin #	Function	Pin #	Function
1	RF IN	6	V _{bias}
2	GND 1	7	GND 2
3	GND	8	RF OUT
4	GND	9	GND
5	GND	10	GND

S-Parameter Data

Frequency (MHz)	S11		S21			S12			S22	
	MAG	ANG	dB	MAG	ANG	dB	MAG	ANG	MAG	ANG
5	0.0928	-30	9.63	3.03	-176	-14.28	0.19	175	0.1105	44
20	0.0576	-32	9.98	3.16	170	-14.02	0.20	170	0.0513	-20
35	0.0384	-22	10.13	3.21	158	-13.95	0.20	161	0.0453	-22
50	0.0323	-3	10.21	3.24	146	-14.05	0.20	151	0.0582	-21
65	0.0355	26	10.29	3.27	136	-14.27	0.19	141	0.0792	-27
80	0.0471	45	10.41	3.31	124	-14.61	0.19	133	0.1042	-37
95	0.0618	50	10.53	3.36	113	-15.03	0.18	124	0.1288	-49
110	0.0778	51	10.71	3.43	102	-15.54	0.17	115	0.1496	-61
125	0.0936	49	10.95	3.53	91	-16.19	0.16	107	0.1639	-74

Recommended Board Layout

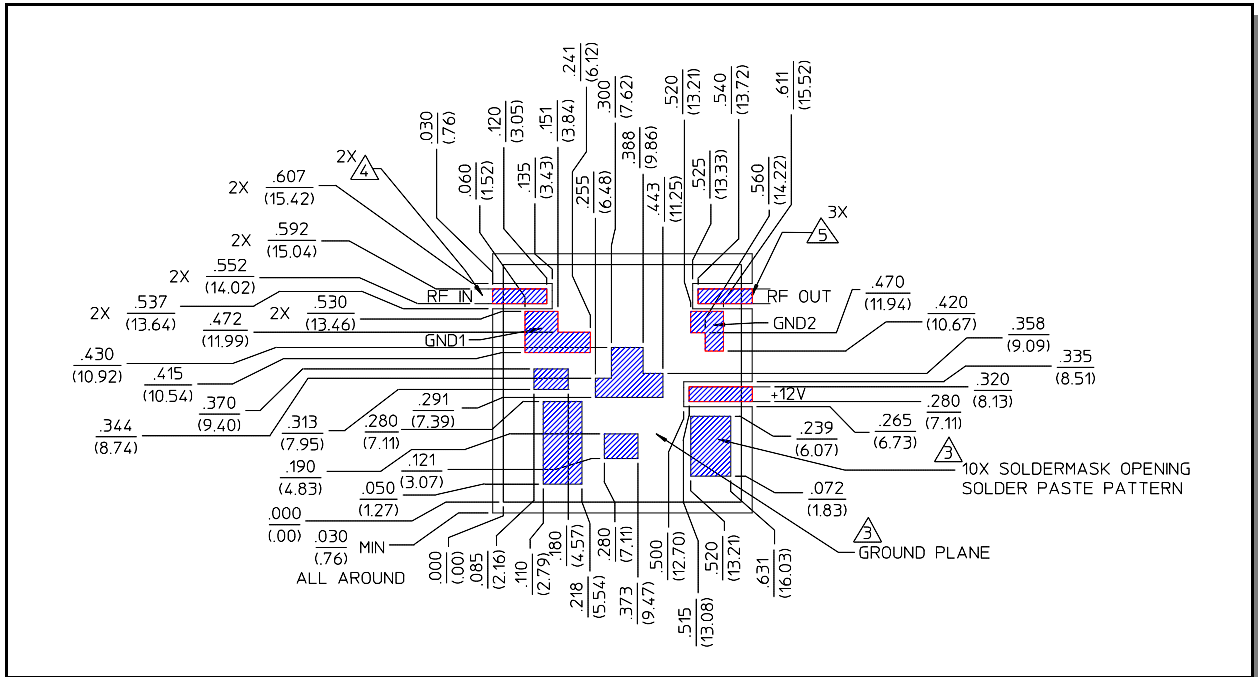

Specifications subject to change without notice.

North America: Tel. (800) 366-2266
Asia/Pacific: Tel.+81-44-844-8296, Fax +81-44-844-8298
Europe: Tel. +44 (1344) 869 595, Fax+44 (1344) 300 020

Typical Performance Curves

Insertion Loss vs. Frequency

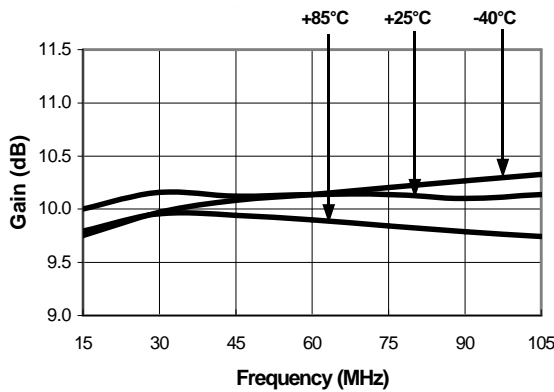

Reverse Isolation vs. Frequency

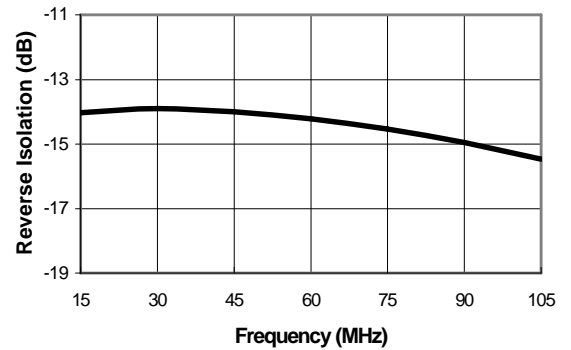

VSWR vs. Frequency

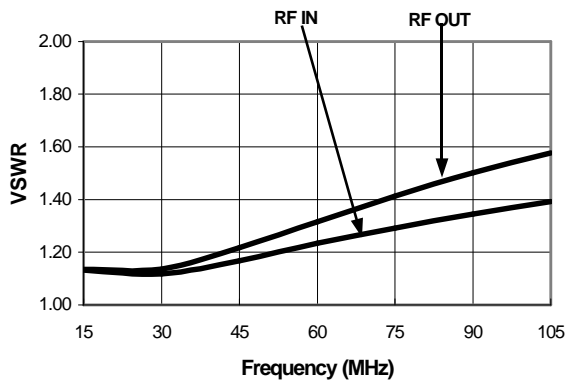

Noise Figure vs. Frequency

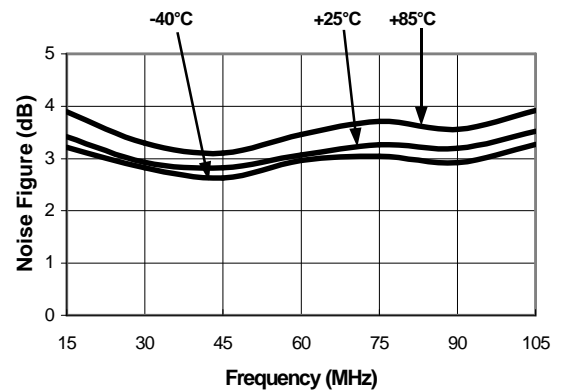

Ordering Information

Part Number	Package
AM05-0006	Bulk Packaging
AM05-0006TR	Tape and Reel (1K Reel)
AM05-0006-TB	Device provided on Test Board

Specifications subject to change without notice.

■ North America: Tel. (800) 366-2266
 ■ Asia/Pacific: Tel.+81-44-844-8296, Fax +81-44-844-8298
 ■ Europe: Tel. +44 (1344) 869 595, Fax+44 (1344) 300 020