

# Am186EM MICROCONTROLLER BLOCK DIAGRAM

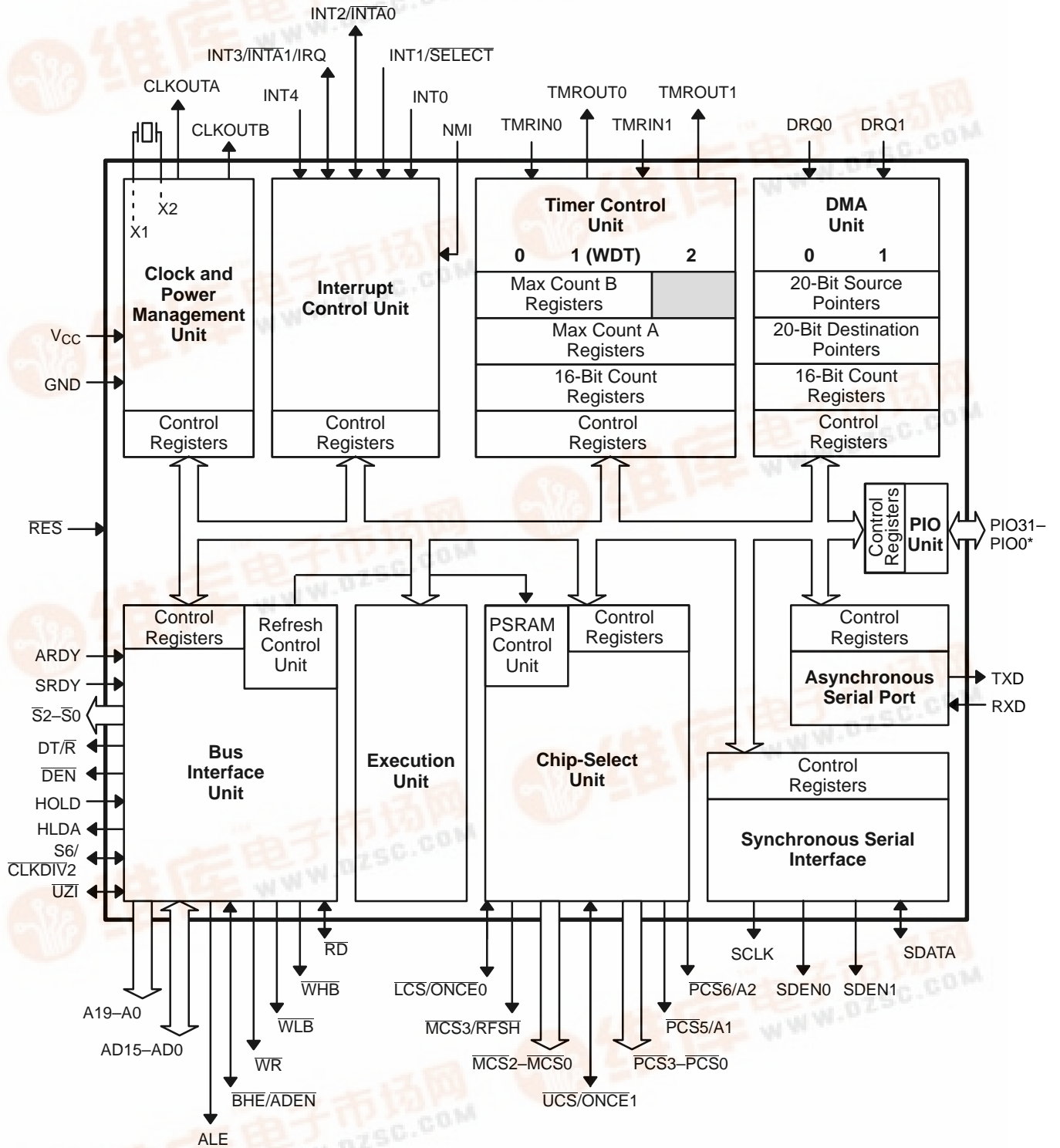

**Note:**

\* All PIO signals are shared with other physical pins. See the pin descriptions beginning on page 24 and Table 2 on page 28 for information on shared function.