



A28F512 512K (64K x 8) CMOS FLASH MEMORY (Automotive)

- **Extended Automotive Temperature Range: -40°C to +125°C**
- **Flash Electrical Chip-Erase**
— 1 Second Typical Chip-Erase
- **Quick-Pulse Programming Algorithm**
— 10 μ s Typical Byte-Program
— 1 Second Chip-Program
- **1,000 Erase/Program Cycle Minimum Over Automotive Temperature Range**
- **12.0V \pm 5% V_{pp}**
- **High-Performance Read**
— 120/150 ns Maximum Access Time
- **CMOS Low Power Consumption**
— 30 mA Maximum Active Current
— 100 μ A Maximum Standby Current
- **Integrated Program/Erase Stop Timer**
- **Command Register Architecture for Microprocessor/Microcontroller Compatible Write Interface**
- **Noise Immunity Features**
— \pm 10% V_{CC} Tolerance
— Maximum Latch-Up Immunity through EPI Processing
- **ETOX™ II Flash Nonvolatile Memory Technology**
— EPROM-Compatible Process Base
— High-Volume Manufacturing Experience
- **JEDEC-Standard Pinouts**
— 32-Pin Plastic DIP
— 32-Pin PLCC
(See Packaging Spec., Order # 231369)

Intel's 28F512 CMOS flash memory offers the most cost-effective and reliable alternative for read/write random access nonvolatile memory. The 28F512 adds electrical chip-erase and reprogramming to familiar EPROM technology. Memory contents can be rewritten: in a test socket; in a PROM-programmer socket; on-board during subassembly test; in-system during final test; and in-system after-sale. The 28F512 increases memory flexibility, while contributing to time- and cost-savings.

The 28F512 is a 512-kilobit nonvolatile memory organized as 65,536 bytes of 8 bits. Intel's 28F512 is offered in 32-pin cerdip or 32-lead PLCC packages. Pin assignments conform to JEDEC standards.

Extended erase and program cycling capability is designed into Intel's ETOX™ II (EPROM Tunnel Oxide) process technology. Advanced oxide processing, an optimized tunneling structure, and lower electric field combine to extend reliable cycling beyond that of traditional EEPROMs. With the 12.0V V_{pp} supply, the 28F512 performs a minimum of 1,000 erase and program cycles well within the time limits of the Quick-Pulse Programming and Quick-Erase algorithms.

Intel's 28F512 employs advanced CMOS circuitry for systems requiring high-performance access speeds, low power consumption, and immunity to noise. Its 150 nanosecond access time provides no-WAIT-state performance for a wide range of microprocessors and microcontrollers. Maximum standby current of 100 μ A translates into power savings when the device is deselected. Finally, the highest degree of latch-up protection is achieved through Intel's unique EPI processing. Prevention of latch-up is provided for stresses up to 100 mA on address and data pins, from -1V to V_{CC} + 1V.

With Intel's ETOX II process base, the 28F512 leverages years of EPROM experience to yield the highest levels of quality, reliability, and cost-effectiveness.

In order to meet the rigorous environmental requirements of Automotive applications, Intel offers the 28F512 in extended Automotive temperature range. Read and Write Characteristics are guaranteed over the range of -40°C to +125°C ambient.



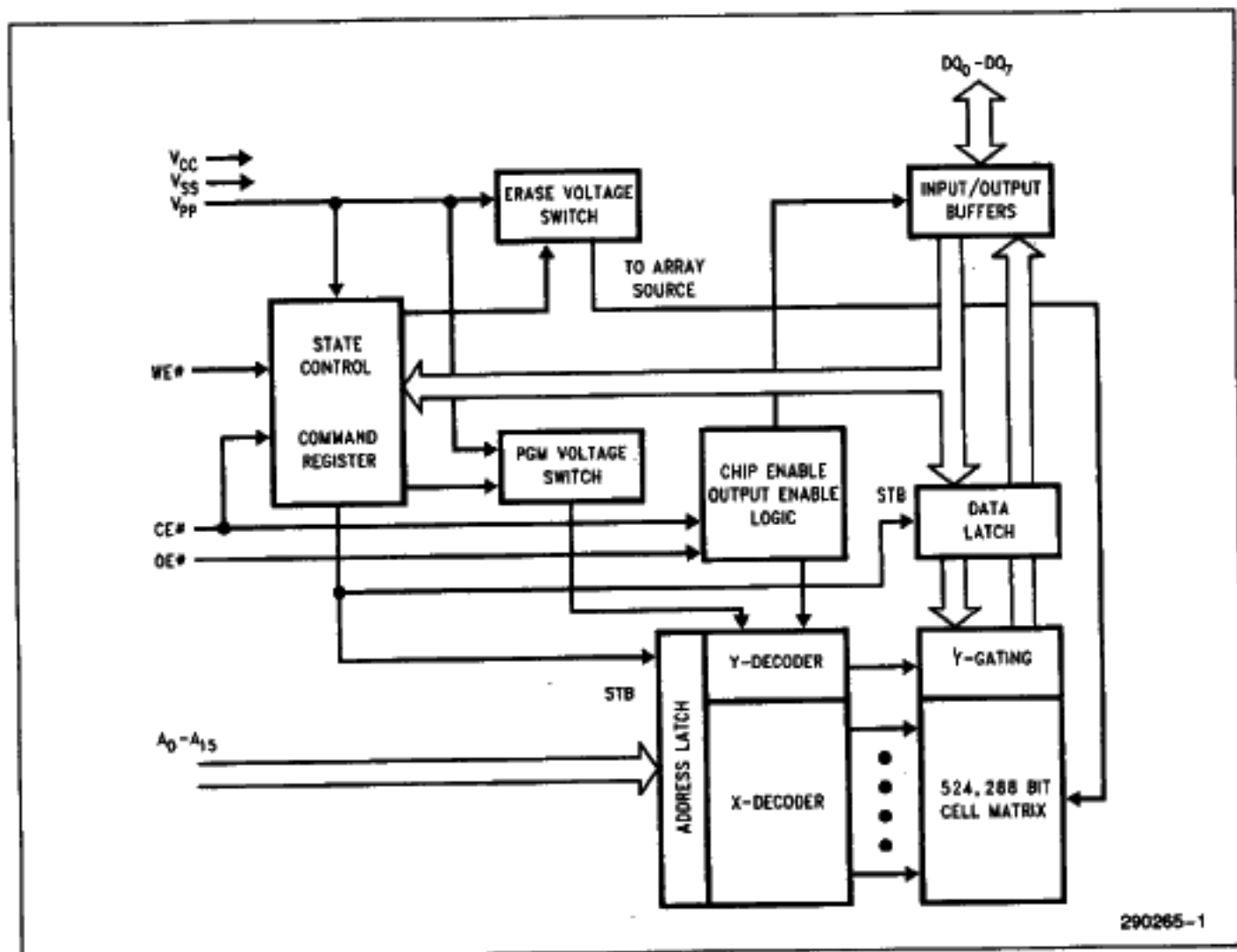

Figure 1. 28F512 Block Diagram

AUTOMOTIVE TEMPERATURE FLASH MEMORIES

The Intel Automotive Flash Memories have received additional processing to enhance product characteristics. The automotive temperature range is -40°C to $+125^{\circ}\text{C}$ during the read/write/erase/program operations.

Speed Versions	Packaging Options	
	Plastic DIP	PLCC
-120	AP	AN
-150	AP	AN

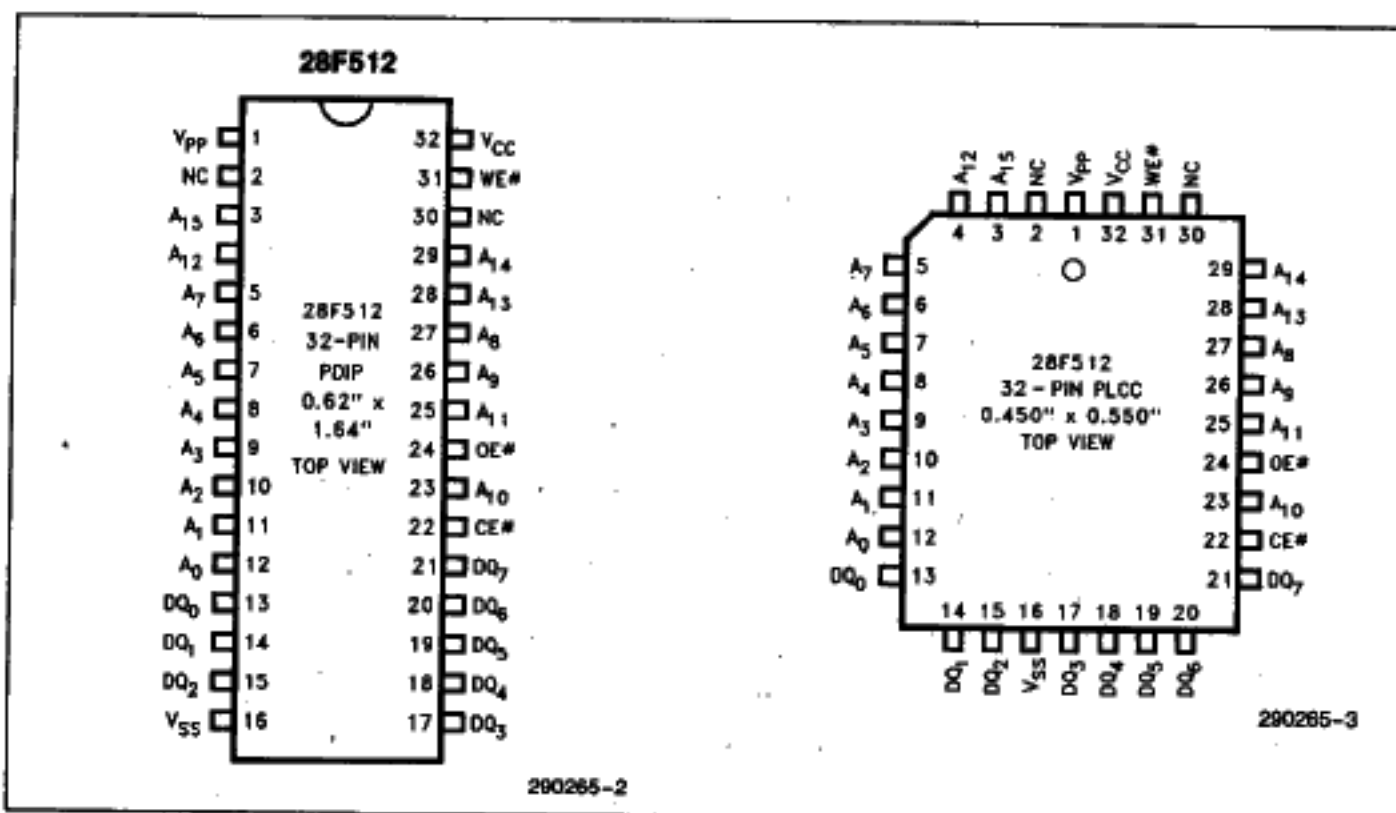

Figure 2. 28F512 Pin Configurations

Table 1. Pin Description

Symbol	Type	Name and Function
A ₀ -A ₁₅	INPUT	ADDRESS INPUTS for memory addresses. Addresses are internally latched during a write cycle.
DQ ₀ -DQ ₇	INPUT/OUTPUT	DATA INPUT/OUTPUT: Inputs data during memory write cycles; outputs data during memory read cycles. The data pins are active high and float to tri-state OFF when the chip is deselected or the outputs are disabled. Data is internally latched during a write cycle.
CE#	INPUT	CHIP ENABLE: Activates the device's control logic, input buffers, decoders and sense amplifiers. CE# is active low; CE# high deselects the memory device and reduces power consumption to standby levels.
OE#	INPUT	OUTPUT ENABLE: Gates the devices output through the data buffers during a read cycle. OE# is active low.
WE#	INPUT	WRITE ENABLE: Controls writes to the control register and the array. Write enable is active low. Addresses are latched on the falling edge and data is latched on the rising edge of the WE# pulse. Note: With V _{PP} ≤ 6.5V, memory contents cannot be altered.
V _{PP}		ERASE/PROGRAM POWER SUPPLY for writing the command register, erasing the entire array, or programming bytes in the array.
V _{CC}		DEVICE POWER SUPPLY (5V ± 10%)
V _{SS}		GROUND
NC		NO INTERNAL CONNECTION to device. Pin may be driven or left floating.

APPLICATIONS

The 28F512 flash-memory adds electrical chip-erase and reprogrammability to EPROM non-volatility and ease of use. The 28F512 is ideal for storing code or data-tables in applications where periodic updates are required. The 28F512 also serves as a dense, nonvolatile data acquisition and storage medium.

The need for code updates pervades all phases of a system's life—from prototyping to system manufacture to after-sale service. In the factory, during prototyping, revisions to control code necessitate ultraviolet erasure and reprogramming of EPROM-based prototype codes. The 28F512 replaces the 15- to 20-minute ultraviolet erasure with one-second electrical erasure. Electrical chip-erase and reprogramming occur in the same workstation or PROM-programmer socket.

Diagnostics, performed at subassembly or final assembly stages, often require the socketing of EPROMs. Socketed test codes are ultimately replaced with EPROMs containing the final program. With electrical chip-erase and reprogramming, the 28F512 is soldered to the circuit board. Test codes are programmed into the 28F512 as it resides on the circuit board. Ultimately, the final code can be downloaded to the device. The 28F512's in-circuit alterability eliminates unnecessary handling and less-reliable socketed connections, while adding greater test flexibility.

Material and labor costs associated with code changes increase at higher levels of system integration—the most costly being code updates after sale.

Code "bugs", or the desire to augment system functionality, prompt after-sale code updates. Field revisions to EPROM-based code require the removal of EPROM components or entire boards.

Designing with the in-circuit alterable 28F512 eliminates socketed memories, reduces overall material costs, and drastically cuts the labor costs associated with code updates. With the 28F512, code updates are implemented locally via an edge-connector, or remotely over a serial communication link.

The 28F512's electrical chip-erase, byte reprogrammability, and complete nonvolatility fit well with data accumulation needs. Electrical chip-erase gives the designer a "blank-slate" in which to log data. Data can be periodically off-loaded for analysis—erasing the slate and repeating the cycle. Or, multiple devices can maintain a "rolling window" of accumulated data.

With high density, nonvolatility, and extended cycling capability, the 28F512 offers an innovative alternative for mass storage.

Integrating main memory and backup storage functions into directly executable flash memory boosts system performance, shrinks system size, and cuts power consumption. Reliability exceeds that of electromechanical media, with greater durability in extreme environmental conditions.

A high degree of on-chip feature integration simplifies memory-to-processor interfacing. Figure 3 depicts two 28F512s tied to the 80C186 system bus. The 28F512's architecture minimizes interface circuitry needed for complete in-circuit updates of memory contents.

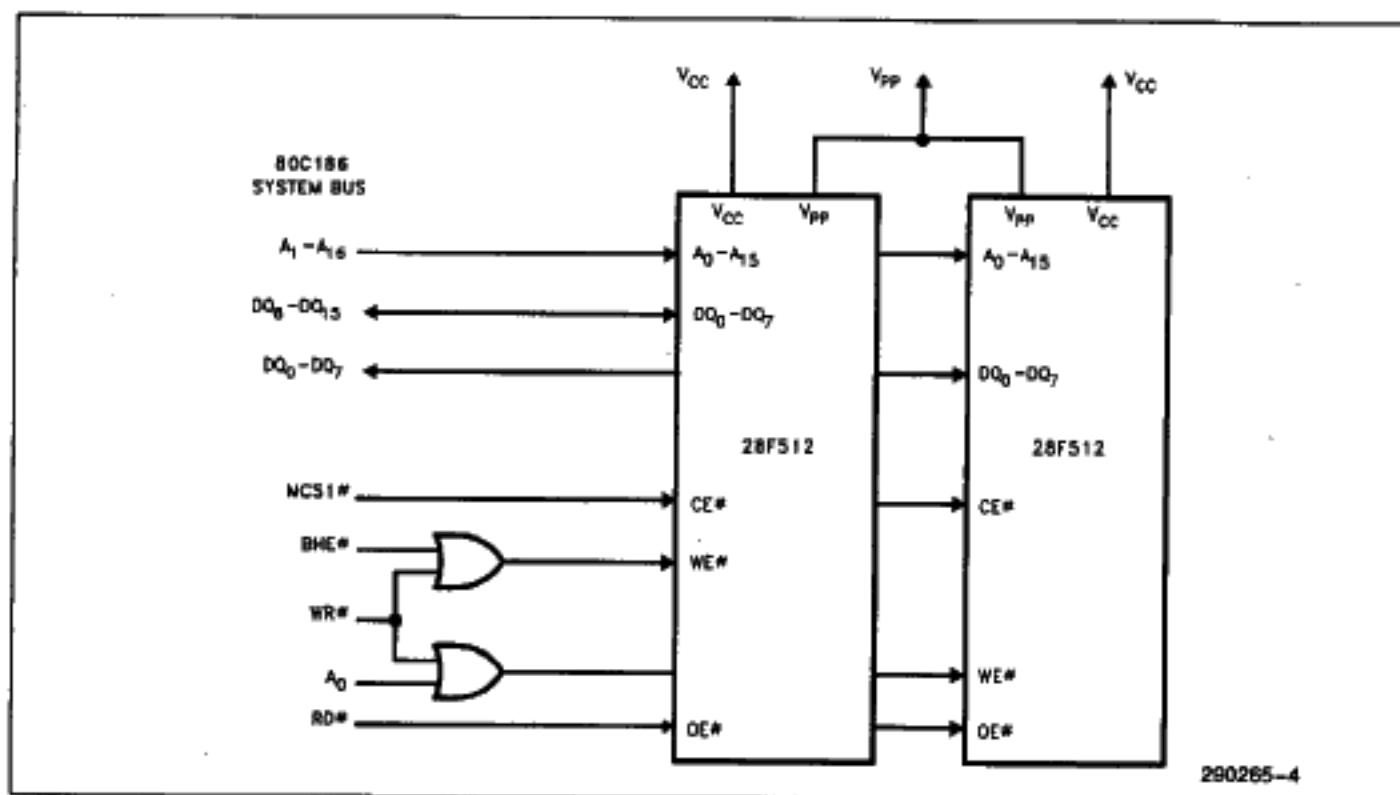

Figure 3. 28F512 in an 80C186 System

With cost-effective in-system reprogramming and extended cycling capability, the 28F512 fills the functionality gap between traditional EPROMs and EEPROMs. EPROM-compatible specifications, straightforward interfacing, and in-circuit alterability allows designers to easily augment memory flexibility and satisfy the need for updatable nonvolatile storage in today's designs.

PRINCIPLES OF OPERATION

Flash-memory augments EPROM functionality with in-circuit electrical erasure and reprogramming. The 28F512 introduces a command register to manage this new functionality. The command register allows for: 100% TTL-level control inputs; fixed power supplies during erasure and programming; and maximum EPROM compatibility.

In the absence of high voltage on the V_{pp} pin, the 28F512 is a read-only memory. Manipulation of the external memory-control pins yields the standard EPROM read, standby, output disable, and Intelligent Identifier operations.

The same EPROM read, standby, and output disable operations are available when high voltage is applied to the V_{pp} pin. In addition, high voltage on V_{pp} enables erasure and programming of the device. All functions associated with altering memory contents—Intelligent Identifier, erase, erase verify, program, and program verify—are accessed via the command register.

Commands are written to the register using standard microprocessor write timings. Register contents serve as input to an internal state-machine which controls the erase and programming circuitry. Write cycles also internally latch addresses and data needed for programming or erase operations. With the appropriate command written to the register, standard microprocessor read timings output array data, access the Intelligent Identifier codes, or output data for erase and program verification.

Integrated Program/Erase Stop Timer

Successive command write cycles define the durations of program and erase operations; specifically, the program or erase time durations are normally terminated by associated program or erase verify commands. An integrated stop timer provides simplified timing control over these operations; thus eliminating the need for maximum program/erase timing specifications. Program and erase pulse durations are minimums only. When the stop timer terminates a program or erase operation, the device enters an inactive state and remains inactive until receiving the appropriate verify or reset command.

Write Protection

The command register is only alterable when V_{pp} is at high voltage. Depending upon the application, the system designer may choose to make the V_{pp} power supply switchable—available only when memory updates are desired. When high voltage is removed,

Table 2. 28F512 Bus Operations

Pins		V _{PP} (1)	A ₀	A ₉	CE #	OE #	WE #	DQ ₀ -DQ ₇
Operation								
READ-ONLY	Read	V _{PPL}	A ₀	A ₉	V _{IL}	V _{IL}	V _{IH}	Data Out
	Output Disable	V _{PPL}	X	X	V _{IL}	V _{IH}	V _{IH}	Tri-State
	Standby	V _{PPL}	X	X	V _{IH}	X	X	Tri-State
	Intelligent Identifier (Mfr) ⁽²⁾	V _{PPL}	V _{IL}	V _{ID} ⁽³⁾	V _{IL}	V _{IL}	V _{IH}	Data = 89H
	Intelligent Identifier (Device) ⁽²⁾	V _{PPL}	V _{IH}	V _{ID} ⁽³⁾	V _{IL}	V _{IL}	V _{IH}	Data = B8H
READ/WRITE	Read	V _{PPH}	A ₀	A ₉	V _{IL}	V _{IL}	V _{IH}	Data Out ⁽⁴⁾
	Output Disable	V _{PPH}	X	X	V _{IL}	V _{IH}	V _{IH}	Tri-State
	Standby ⁽⁵⁾	V _{PPH}	X	X	V _{IH}	X	X	Tri-State
	Write	V _{PPH}	A ₀	A ₉	V _{IL}	V _{IH}	V _{IL}	Data In ⁽⁶⁾

2

NOTES:

1. V_{PPL} may be ground, a no-connect with a resistor tied to ground, or ≤ 6.5V. V_{PPH} is the programming voltage specified for the device. Refer to D.C. Characteristics. When V_{PP} = V_{PPL} memory contents can be read but not written or erased.
2. Manufacturer and device codes may also be accessed via a command register write sequence. Refer to Table 3. All other addresses low.
3. V_{ID} is the Intelligent Identifier high voltage. Refer to DC Characteristics.
4. Read operations with V_{PP} = V_{PPH} may access array data or the Intelligent Identifier codes.
5. With V_{PP} at high voltage, the standby current equals I_{CC} + I_{PP} (standby).
6. Refer to Table 3 for valid Data-In during a write operation.
7. X can be V_{IL} or V_{IH}.

the contents of the register default to the read command, making the 28F512 a read-only memory. Memory contents cannot be altered.

Or, the system designer may choose to “hardwire” V_{PP}, making the high voltage supply constantly available. In this instance, all operations are performed in conjunction with the command register. The 28F512 is designed to accommodate either design practice, and to encourage optimization of the processor-memory interface.

The two-step program/erase write sequence to the Command Register provides additional software write protection.

BUS OPERATIONS

Read

The 28F512 has two control functions, both of which must be logically active, to obtain data at the outputs. Chip-Enable (CE #) is the power control and should be used for device selection. Output-Enable (OE #) is the output control and should be used to gate data from the output pins, independent of device selection. Figure 6 illustrates read timing waveforms.

When V_{PP} is low (V_{PPL}), the read only operation is active. This permits reading the data in the array and outputting the Intelligent Identifier codes (see Table 2). When V_{PP} is high (V_{PPH}), the default condition of the device is the read only mode. This allows reading the data in the array. Further functionality is achieved through the Command Register as shown in Table 3.

Output Disable

With Output-Enable at a logic-high level (V_{IH}), output from the device is disabled. Output pins are placed in a high-impedance state.

Standby

With Chip-Enable at a logic-high level, the standby operation disables most of the 28F512's circuitry and substantially reduces device power consumption. The outputs are placed in a high-impedance state, independent of the Output-Enable signal. If the 28F512 is deselected during erasure, programming, or program/erase verification, the device draws active current until the operation is terminated.

Intelligent Identifier Operation

The Intelligent Identifier operation outputs the manufacturer code (89H) and device code (B8H). Pro-

A28F512



programming equipment automatically matches the device with its proper erase and programming algorithms.

With Chip-Enable and Output-Enable at a logic low level, raising A9 to high voltage V_{DD} (see DC Characteristics) activates the operation. Data read from locations 0000H and 0001H represent the manufacturer's code and the device code, respectively.

The manufacturer- and device-codes can also be read via the command register, for instances where the 28F512 is erased and reprogrammed in the target system. Following a write of 90H to the command register, a read from address location 0000H outputs the manufacturer code (89H). A read from address 0001H outputs the device code (B8H).

Write

Device erasure and programming are accomplished via the command register, when high voltage is applied to the V_{pp} pin. The contents of the register serve as input to the internal state-machine. The state-machine outputs dictate the function of the device.

The command register itself does not occupy an addressable memory location. The register is a latch used to store the command, along with address and data information needed to execute the command.

The command register is written by bringing Write-Enable to a logic-low level (V_{IL}), while Chip-Enable is low. Addresses are latched on the falling edge of Write-Enable, while data is latched on the rising edge of the Write-Enable pulse. Standard microprocessor write timings are used.

Refer to A.C. Write Characteristics and the Erase/Programming Waveforms for specific timing parameters.

COMMAND DEFINITIONS

When low voltage is applied to the V_{pp} pin, the contents of the command register default to 00H, enabling read-only operations.

Placing high voltage on the V_{pp} pin enables read/write operations. Device operations are selected by writing specific data patterns into the command register. Table 3 defines these 28F512 register commands.

Table 3. Command Definitions

Command	Bus Cycles Req'd	First Bus Cycle			Second Bus Cycle		
		Operation(1)	Address(2)	Data(3)	Operation(1)	Address(2)	Data(3)
Read Memory	1	Write	X	00H			
Read Intelligent Identifier Code(4)	2	Write	X	90H	Read	IA	ID
Set-up Erase/Erase(5)	2	Write	X	20H	Write	X	20H
Erase Verify(5)	2	Write	EA	A0H	Read	X	EVD
Set-up Program/Program(6)	2	Write	X	40H	Write	PA	PD
Program Verify(6)	2	Write	X	C0H	Read	X	PVD
Reset(7)	2	Write	X	FFH	Write	X	FFH

NOTES:

- Bus operations are defined in Table 2.
- IA = Identifier address: 00H for manufacturer code, 01H for device code.
EA = Address of memory location to be read during erase verify.
PA = Address of memory location to be programmed.
Addresses are latched on the falling edge of the Write-Enable pulse.
- ID = Data read from location IA during device identification (Mfr = 89H, Device = B8H).
EVD = Data read from location EA during erase verify.
PD = Data to be programmed at location PA. Data is latched on the rising edge of Write-Enable.
PVD = Data read from location PA during program verify. PA is latched on the Program command.
- Following the Read Intelligent ID command, two read operations access manufacturer and device codes.
- Figure 5 illustrates the Quick-Erase algorithm.
- Figure 4 illustrates the Quick-Pulse Programming algorithm.
- The second bus cycle must be followed by the desired command register write.



Read Command

While V_{PP} is high, for erasure and programming, memory contents can be accessed via the read command. The read operation is initiated by writing 00H into the command register. Microprocessor read cycles retrieve array data. The device remains enabled for reads until the command register contents are altered.

The default contents of the register upon V_{PP} power-up is 00H. This default value ensures that no spurious alteration of memory contents occurs during the V_{PP} power transition. Where the V_{PP} supply is hard-wired to the 28F512, the device powers-up and remains enabled for reads until the command-register contents are changed. Refer to the A.C. Read Characteristics and Waveforms for specific timing parameters.

Intelligent Identifier Command

Flash-memories are intended for use in applications where the local CPU alters memory contents. As such, manufacturer- and device-codes must be accessible while the device resides in the target system. PROM programmers typically access signature codes by raising A9 to a high voltage. However, multiplexing high voltage onto address lines is not a desired system-design practice.

The 28F512 contains an Intelligent Identifier operation to supplement traditional PROM-programming methodology. The operation is initiated by writing 90H into the command register. Following the command write, a read cycle from address 0000H retrieves the manufacturer code of 89H. A read cycle from address 0001H returns the device code of B8H. To terminate the operation, it is necessary to write another valid command into the register.

Set-up Erase/Erase Commands

Set-up Erase is a command-only operation that stages the device for electrical erasure of all bytes in the array. The set-up erase operation is performed by writing 20H to the command register.

To commence chip-erasure, the erase command (20H) must again be written to the register. The erase operation begins with the rising edge of the Write-Enable pulse and terminates with the rising edge of the next Write-Enable pulse (i.e., Erase-Verify Command).

This two-step sequence of set-up followed by execution ensures that memory contents are not accidentally erased. Also, chip-erasure can only occur when

high voltage is applied to the V_{PP} pin. In the absence of this high voltage, memory contents are protected against erasure. Refer to A.C. Erase Characteristics and Waveforms for specific timing parameters.

Erase-Verify Command

The erase command erases all bytes of the array in parallel. After each erase operation, all bytes must be verified. The erase verify operation is initiated by writing A0H into the command register. The address for the byte to be verified must be supplied as it is latched on the falling edge of the Write-Enable pulse. The register write terminates the erase operation with the rising edge of its Write-Enable pulse.

The 28F512 applies an internally-generated margin voltage to the addressed byte. Reading FFH from the addressed byte indicates that all bits in the byte are erased.

2

The erase-verify command must be written to the command register prior to each byte verification to latch its address. The process continues for each byte in the array until a byte does not return FFH data, or the last address is accessed.

In the case where the data read is not FFH, another erase operation is performed. (Refer to Set-up Erase/Erase). Verification then resumes from the address of the last-verified byte. Once all bytes in the array have been verified, the erase step is complete. The device can be programmed. At this point, the verify operation is terminated by writing a valid command (e.g. Program Set-up) to the command register. Figure 5, the Quick-Erase algorithm, illustrates how commands and bus operations are combined to perform electrical erasure of the 28F512. Refer to A.C. Erase Characteristics and Waveforms for specific timing parameters.

Set-up Program/Program Commands

Set-up program is a command-only operation that stages the device for byte programming. Writing 40H into the command register performs the set-up operation.

Once the program set-up operation is performed, the next Write-Enable pulse causes a transition to an active programming operation. Addresses are internally latched on the falling edge of the Write-Enable pulse. Data is internally latched on the rising edge of the Write-Enable pulse. The rising edge of Write-Enable also begins the programming operation. The programming operation terminates with the next rising edge of Write-Enable, used to write the program-verify command. Refer to A.C. Program-

A28F512



ming Characteristics and Waveforms for specific timing parameters.

Program-Verify Command

The 28F512 is programmed on a byte-by-byte basis. Byte programming may occur sequentially or at random. Following each programming operation, the byte just programmed must be verified.

The program-verify operation is initiated by writing C0H into the command register. The register write terminates the programming operation with the rising edge of its Write-Enable pulse. The program-verify operation stages the device for verification of the byte last programmed. No new address information is latched.

The 28F512 applies an internally-generated margin voltage to the byte. A microprocessor read cycle outputs the data. A successful comparison between the programmed byte and true data means that the byte is successfully programmed. Programming then proceeds to the next desired byte location. Figure 4, the 28F512 Quick-Pulse Programming algorithm, illustrates how commands are combined with bus operations to perform byte programming. Refer to A.C. Programming Characteristics and Waveforms for specific timing parameters.

Reset Command

A reset command is provided as a means to safely abort the erase- or program-command sequences. Following either set-up command (erase or program) with two consecutive writes of FFH will safely abort the operation. Memory contents will not be altered. A valid command must then be written to place the device in the desired state.

EXTENDED ERASE/PROGRAM CYCLING

EEPROM cycling failures have always concerned users. The high electrical field required by thin oxide EEPROMs for tunneling can literally tear apart the oxide at defect regions. To combat this, some suppliers have implemented redundancy schemes, reducing cycling failures to insignificant levels. However, redundancy requires that cell size be doubled—an expensive solution.

Intel has designed extended cycling capability into its ETOX-II flash memory technology. Resulting improvements in cycling reliability come without increasing memory cell size or complexity. First, an advanced tunnel oxide increases the charge carrying ability ten-fold. Second, the oxide area per cell subjected to the tunneling electric field is one-tenth that of common EEPROMs, minimizing the probabili-

ty of oxide defects in the region. Finally, the peak electric field during erasure is approximately 2 MV/cm lower than EEPROM. The lower electric field greatly reduces oxide stress and the probability of failure—increasing time to wearout by a factor of 100,000,000.

The device is programmed and erased using Intel's Quick-Pulse Programming and Quick-Erase algorithms. Intel's algorithmic approach uses a series of operations (pulses), along with byte verification, to completely and reliably erase and program the device.

QUICK-PULSE PROGRAMMING ALGORITHM

The Quick-Pulse Programming algorithm uses programming operations of 10 μ s duration. Each operation is followed by a byte verification to determine when the addressed byte has been successfully programmed. The algorithm allows for up to 25 programming operations per byte, although most bytes verify on the first or second operation. The entire sequence of programming and byte verification is performed with V_{pp} at high voltage. Figure 4 illustrates the Quick-Pulse Programming algorithm.

QUICK-ERASE ALGORITHM

Intel's Quick-Erase algorithm yields fast and reliable electrical erasure of memory contents. The algorithm employs a closed-loop flow, similar to the Quick-Pulse Programming algorithm, to simultaneously remove charge from all bits in the array.

Erasure begins with a read of memory contents. The 28F512 is erased when shipped from the factory. Reading FFH data from the device would immediately be followed by device programming.

For devices being erased and reprogrammed, uniform and reliable erasure is ensured by first programming all bits in the device to their charged state (Data = 00H). This is accomplished, using the Quick-Pulse Programming algorithm, in approximately one second.

Erase execution then continues with an initial erase operation. Erase verification (data = FFH) begins at address 0000H and continues through the array to the last address, or until data other than FFH is encountered. With each erase operation, an increasing number of bytes verify to the erased state. Erase efficiency may be improved by storing the address of the last byte verified in a register. Following the next erase operation, verification starts at that stored address location. Erasure typically occurs in one second. Figure 5 illustrates the Quick-Erase algorithm.

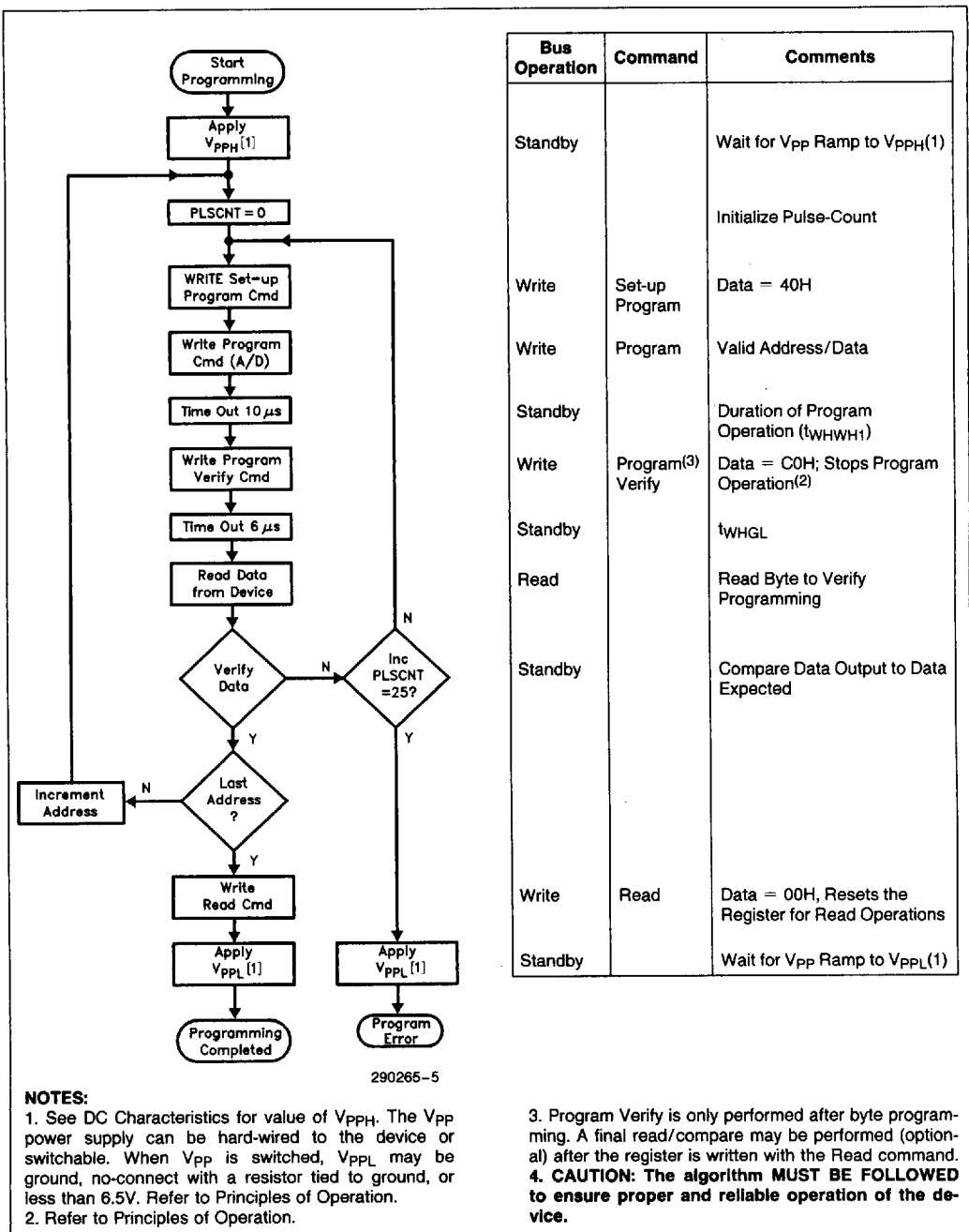

Bus Operation	Command	Comments
Standby		Wait for V _{PP} Ramp to V _{PPH} (1)
		Initialize Pulse-Count
Write	Set-up Program	Data = 40H
Write	Program	Valid Address/Data
Standby		Duration of Program Operation (t _{WHWH1})
Write	Program ⁽³⁾ Verify	Data = C0H; Stops Program Operation ⁽²⁾
Standby		t _{WHGL}
Read		Read Byte to Verify Programming
Standby		Compare Data Output to Data Expected
Write	Read	Data = 00H, Resets the Register for Read Operations
Standby		Wait for V _{PP} Ramp to V _{PPL} (1)

NOTES:

1. See DC Characteristics for value of V_{PPH}. The V_{PP} power supply can be hard-wired to the device or switchable. When V_{PP} is switched, V_{PPL} may be ground, no-connect with a resistor tied to ground, or less than 6.5V. Refer to Principles of Operation.
2. Refer to Principles of Operation.

3. Program Verify is only performed after byte programming. A final read/compare may be performed (optional) after the register is written with the Read command.
4. **CAUTION: The algorithm MUST BE FOLLOWED to ensure proper and reliable operation of the device.**

Figure 4. 28F512 Quick-Pulse Programming Algorithm

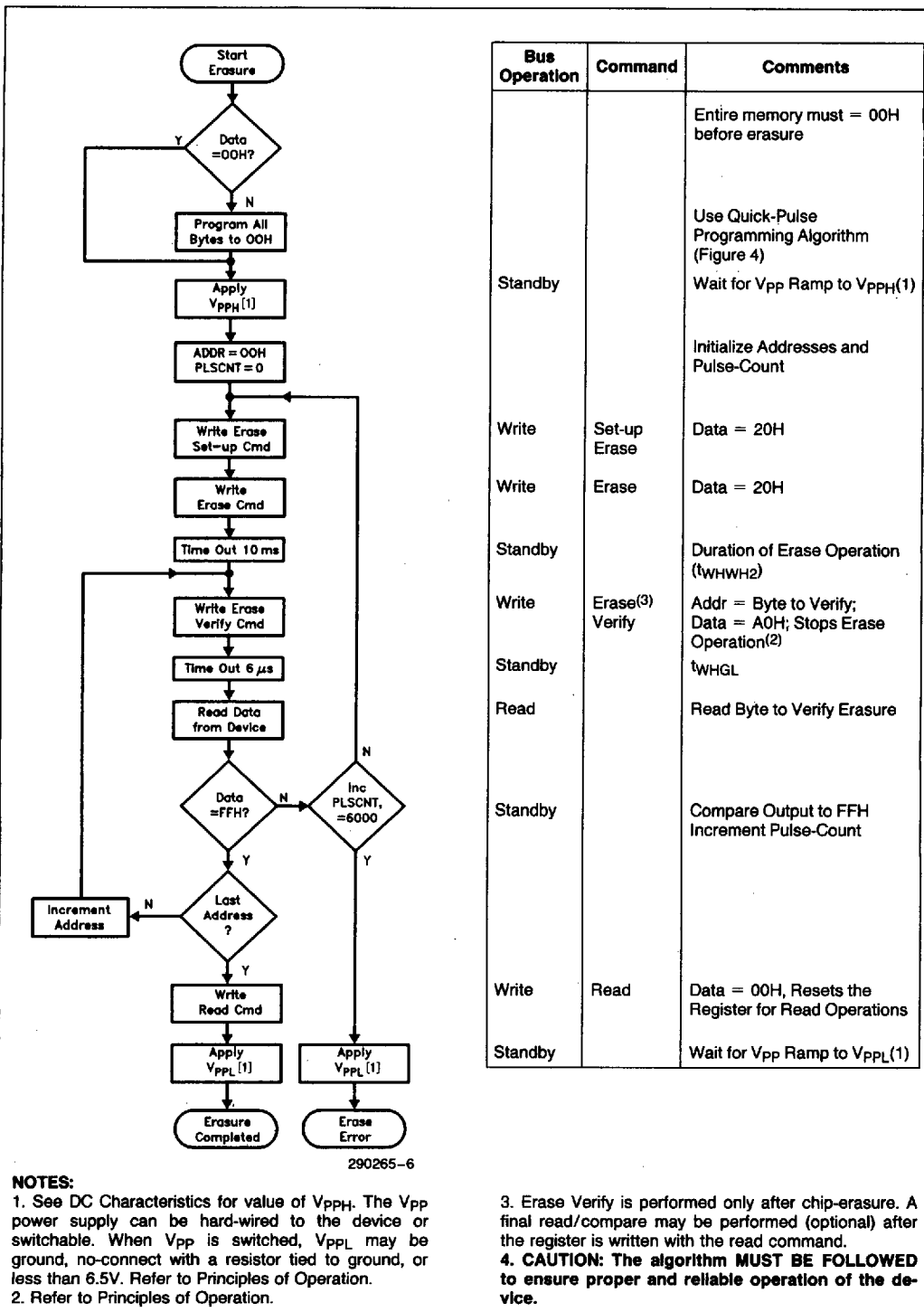

Figure 5 28F512 Quick-Erase Algorithm



DESIGN CONSIDERATIONS

Two-Line Output Control

Flash-memories are often used in larger memory arrays. Intel provides two read-control inputs to accommodate multiple memory connections. Two-line control provides for:

- a. the lowest possible memory power dissipation and,
- b. complete assurance that output bus contention will not occur.

To efficiently use these two control inputs, an address-decoder output should drive chip-enable, while the system's read signal controls all flash-memories and other parallel memories. This assures that only enabled memory devices have active outputs, while deselected devices maintain the low power standby condition.

Power Supply Decoupling

Flash memory power-switching characteristics require careful device decoupling. System designers are interested in three supply current (I_{CC}) issues—standby, active, and transient current peaks produced by falling and rising edges of chip-enable. The capacitive and inductive loads on the device outputs determine the magnitudes of these peaks.

Two-line control and proper decoupling capacitor selection will suppress transient voltage peaks. Each device should have a $0.1 \mu\text{F}$ ceramic capacitor connected between V_{CC} and V_{SS} , and between V_{PP} and V_{SS} .

Place the high-frequency, low-inherent-inductance capacitors as close as possible to the devices. Also, for every eight devices, a $4.7 \mu\text{F}$ electrolytic capacitor should be placed at the array's power supply connection, between V_{CC} and V_{SS} . The bulk capacitor will overcome voltage slumps caused by printed-circuit-board trace inductance, and will supply charge to the smaller capacitors as needed.

V_{PP} Trace on Printed Circuit Boards

Programming flash-memories, while they reside in the target system, requires that the printed circuit board designer pay attention to the V_{PP} power supply trace. The V_{PP} pin supplies the memory cell current for programming. Use similar trace widths and layout considerations given the V_{CC} power bus. Adequate V_{PP} supply traces and decoupling will decrease V_{PP} voltage spikes and overshoots.

2

Power Up/Down Protection

The 28F512 is designed to offer protection against accidental erasure or programming, caused by spurious system-level signals that may exist during power transitions. Also, with its control register architecture, alteration of memory contents only occurs after successful completion of the two-step command sequences. Power supply sequencing is not required. Internal circuitry of the 28F512 ensures that the command register architecture is reset to the read mode on power up.

A system designer must guard against active writes for V_{CC} voltages above the V_{LKO} when V_{PP} is active. Since both $WE\#$ and $CE\#$ must be low for a command write, driving either to V_{IH} will prohibit writes.

A28F512



The control register architecture provides an added level of protection since alteration of memory contents only occurs after successful completion of the two-step command sequences.

28F512 Power Dissipation

When designing portable systems, designers must consider battery power consumption not only during device operation, but also for data retention during system idle time. Flash nonvolatility increases the usable battery life of your system because the 28F512 does not consume any power to retain code or data when the system is off. Table 4 illustrates the power dissipated when updating the 28F512.

Table 4. 28F512 Typical Update Power Dissipation⁽⁴⁾

Operation	Power Dissipation (Watt-Seconds)	Notes
Array Program/ Program Verify	0.085	1
Array Erase/ Erase Verify	0.092	2
One Complete Cycle	0.262	3

NOTES:

1. Formula to calculate typical Program/Program Verify Power = $[V_{PP} \times \# \text{ Bytes} \times \text{typical} \# \text{ Prog Pulses} (t_{WHWH1} \times I_{PP2} \text{ typical} + t_{WHGL} \times I_{PP4} \text{ typical})] + [V_{CC} \times \# \text{ Bytes} \times \text{typical} \# \text{ Prog Pulses} (t_{WHWH1} \times I_{CC2} \text{ typical} + t_{WHGL} \times I_{CC4} \text{ typical})]$.
2. Formula to calculate typical Erase/Erase Verify Power = $[V_{PP} (I_{PP3} \text{ typical} \times t_{ERASE} \text{ typical} + I_{PP5} \text{ typical} \times t_{WHGL} \times \# \text{ Bytes})] + [V_{CC} (I_{CC3} \text{ typical} \times t_{ERASE} \text{ typical} + I_{CC5} \text{ typical} \times t_{WHGL} \times \# \text{ Bytes})]$.
3. Once Complete Cycle = Array Preprogram + Array Erase + Program.
4. "Typicals" are not guaranteed, but based on a limited number of samples from production lots.



ABSOLUTE MAXIMUM RATINGS*

- Operating Temperature
 - During Read -40°C to +125°C(1)
 - During Erase/Program -40°C to +125°C
- Temperature Under Bias -40°C to +125°C
- Storage Temperature -65°C to +150°C
- Voltage on Any Pin with Respect to Ground -2.0V to +7.0V(2)
- Voltage on Pin A₉ with Respect to Ground -2.0V to +13.5V(2, 3)
- V_{PP} Supply Voltage with Respect to Ground
 - During Erase/Program -2.0V to +14.0V(2, 3)

- V_{CC} Supply Voltage with Respect to Ground -2.0V to +7.0V(2)
- Output Short Circuit Current 100 mA(4)
- Maximum Junction Temperature (T_J) 140°C

NOTICE: This is a production data sheet. The specifications are subject to change without notice.

**WARNING: Stressing the device beyond the "Absolute Maximum Ratings" may cause permanent damage. These are stress ratings only. Operation beyond the "Operating Conditions" is not recommended and extended exposure beyond the "Operating Conditions" may affect device reliability.*

NOTES:

1. Operating temperature is for automotive product as defined by this specification.
2. Minimum DC input voltage is -0.5V. During transitions, inputs may undershoot to -2.0V for periods less than 20 ns. Maximum DC voltage on output pins is V_{CC} + 0.5V, which may overshoot to V_{CC} + 2.0V for periods less than 20 ns.
3. Maximum DC voltage on A₉ or V_{PP} may overshoot to +14.0V for periods less than 20 ns.
4. Output shorted for no more than one second. No more than one output shorted at a time.



OPERATING CONDITIONS

Symbol	Parameter	Limits		Unit	Comments
		Min	Max		
T _A	Operating Temperature	-40	125	°C	For Read-Only and Read/Write Operations
V _{CC}	V _{CC} Supply Voltage	4.50	5.50	V	

DC CHARACTERISTICS—TTL/NMOS COMPATIBLE

Symbol	Parameter	Notes	Limits			Unit	Test Conditions
			Min	Typical	Max		
I _{LI}	Input Leakage Current	1			±1.0	μA	V _{CC} = V _{CC} Max V _{IN} = V _{CC} or V _{SS}
I _{LO}	Output Leakage Current	1			±10	μA	V _{CC} = V _{CC} Max V _{OUT} = V _{CC} or V _{SS}
I _{CCS}	V _{CC} Standby Current	1			1.0	mA	V _{CC} = V _{CC} Max CE# = V _{IH}
I _{CC1}	V _{CC} Active Read Current	1		10	30	mA	V _{CC} = V _{CC} Max, CE# = V _{IL} f = 6 MHz, I _{OUT} = 0 mA
I _{CC2}	V _{CC} Programming Current	1, 2		1.0	30	mA	Programming in Progress
I _{CC3}	V _{CC} Erase Current	1, 2		5.0	30	mA	Erase in Progress
I _{CC4}	V _{CC} Program Verify Current	1, 2		5.0	30	mA	V _{PP} = V _{PPH} Program Verify in Progress
I _{CC5}	V _{CC} Erase Verify Current	1, 2		5.0	30	mA	V _{PP} = V _{PPH} Erase Verify in Progress
I _{PPS}	V _{PP} Leakage Current	1			±10	μA	V _{PP} ≤ V _{CC}
I _{PPR}	V _{PP} Read Current or			90	200	μA	V _{PP} > V _{CC}

DC CHARACTERISTICS—TTL/NMOS COMPATIBLE (Continued)

Symbol	Parameter	Notes	Limits			Unit	Test Conditions
			Min	Typ	Max		
I _{PP2}	V _{PP} Programming Current	1, 2		8.0	30	mA	V _{PP} = V _{PPH} Programming in Progress
I _{PP3}	V _{PP} Erase Current	1, 2		4.0	30	mA	V _{PP} = V _{PPH} Erasure in Progress
I _{PP4}	V _{PP} Program Verify Current	1, 2		2.0	5.0	mA	V _{PP} = V _{PPH} Program Verify in Progress
I _{PP5}	V _{PP} Erase Verify Current	1, 2		2.0	5.0	mA	V _{PP} = V _{PPH} Erase Verify in Progress
V _{IL}	Input Low Voltage		-0.5		0.8	V	
V _{IH}	Input High Voltage		2.0		V _{CC} + 0.5	V	
V _{OL}	Output Low Voltage				0.45	V	I _{OL} = 2.1 mA V _{CC} = V _{CC} Min
V _{OH1}	Output High Voltage		2.4			V	I _{OH} = -2.5 mA V _{CC} = V _{CC} Min
V _{ID}	A ₉ Intelligent Identifier Voltage		11.50		13.00	V	A ₉ = V _{ID}
I _{ID}	V _{CC} ID Current	1		10	30	mA	A ₉ = V _{ID}
	V _{PP} ID Current			90	500	μA	
V _{PPL}	V _{PP} during Read-Only Operations		0.00		6.5	V	NOTE: Erase/Program are inhibited when V _{PP} = V _{PPL}
V _{PPH}	V _{PP} during Read/Write Operations		11.40		12.60	V	
V _{LKO}	V _{CC} Erase/Write Lock Voltage		2.5			V	

DC CHARACTERISTICS—CMOS COMPATIBLE

Symbol	Parameter	Notes	Limits			Unit	Test Conditions
			Min	Typ	Max		
I _{LI}	Input Leakage Current	1			±1.0	μA	V _{CC} = V _{CC} Max V _{IN} = V _{CC} or V _{SS}
I _{LO}	Output Leakage Current	1			±10	μA	V _{CC} = V _{CC} Max V _{OUT} = V _{CC} or V _{SS}
I _{CCS}	V _{CC} Standby Current	1		50	100	μA	V _{CC} = V _{CC} Max CE# = V _{CC} ± 0.2V
I _{CC1}	V _{CC} Active Read Current	1		10	30	mA	V _{CC} = V _{CC} Max, CE# = V _{IL} f = 6 MHz, I _{OUT} = 0 mA
I _{CC2}	V _{CC} Programming Current	1, 2		1.0	30	mA	Programming in Progress
I _{CC3}	V _{CC} Erase Current	1, 2		5.0	30	mA	Erasure in Progress
I _{CC4}	V _{CC} Program Verify Current	1, 2		5.0	30	mA	V _{PP} = V _{PPH} Program Verify in Progress
I _{CC5}	V _{CC} Erase Verify Current	1, 2		5.0	30	mA	V _{PP} = V _{PPH} Erase Verify in Progress



DC CHARACTERISTICS—CMOS COMPATIBLE (Continued)

Symbol	Parameter	Notes	Limits			Unit	Test Conditions
			Min	Typ	Max		
I _{PPS}	V _{PP} Leakage Current	1			± 10	μA	V _{PP} ≤ V _{CC}
I _{PP1}	V _{PP} Read Current or Standby Current	1		90	200	μA	V _{PP} > V _{CC}
					± 10		V _{PP} ≤ V _{CC}
I _{PP2}	V _{PP} Programming Current	1, 2		8.0	30	mA	V _{PP} = V _{PPH} Programming in Progress
I _{PP3}	V _{PP} Erase Current	1, 2		4.0	30	mA	V _{PP} = V _{PPH} Erasure in Progress
I _{PP4}	V _{PP} Program Verify Current	1, 2		2.0	5.0	mA	V _{PP} = V _{PPH} Program Verify in Progress
I _{PP5}	V _{PP} Program Erase Verify Current	1, 2		2.0	5.0	mA	V _{PP} = V _{PPH} Erase Verify in Progress
V _{IL}	Input Low Voltage		-0.5		0.8	V	
V _{IH}	Input High Voltage		0.7 V _{CC}		V _{CC} + 0.5	V	
V _{OL}	Output Low Voltage				0.45	V	I _{OL} = 2.1 mA V _{CC} = V _{CC} Min
V _{OH1}	Output High Voltage		0.85 V _{CC}			V	I _{OH} = -2.5 mA, V _{CC} = V _{CC} Min
V _{OH2}			V _{CC} - 0.4				I _{OH} = -100 μA, V _{CC} = V _{CC} Min
V _{ID}	A ₉ Intelligent Identifier Voltage		11.50		13.00	V	
I _{ID}	V _{CC} ID Current	1		10	30	mA	A ₉ = ID
I _{ID}	V _{PP} ID Current	1		90	500	mA	A ₉ = ID
V _{PPPL}	V _{PP} during Read-Only Operations		0.00		6.5	V	NOTE: Erase/Programs are inhibited when V _{PP} = V _{PPPL}
V _{PPH}	V _{PP} during Read/Write Operations		11.40		12.60	V	V _{PP} = 12.0V
V _{LKO}	V _{CC} Erase/Write Lock Voltage		2.5			V	

2

CAPACITANCE⁽³⁾ T_A = 25°C, f = 1.0 MHz

Symbol	Parameter	Limits		Unit	Conditions
		Min	Max		
C _{IN}	Address/Control Capacitance		8	pF	V _{IN} = 0V
C _{OUT}	Output Capacitance		12	pF	V _{OUT} = 0V

NOTES:

1. All currents are in RMS unless otherwise noted. Typical values at V_{CC} = 5.0V, V_{PP} = 12.0V, T = 25°C.
2. Not 100% tested: characterization data available.
3. Sampled, not 100% tested.
4. "Typicals" are not guaranteed, but are based on a limited number of samples from production lots.

A28F512



AC TESTING INPUT/OUTPUT WAVEFORM

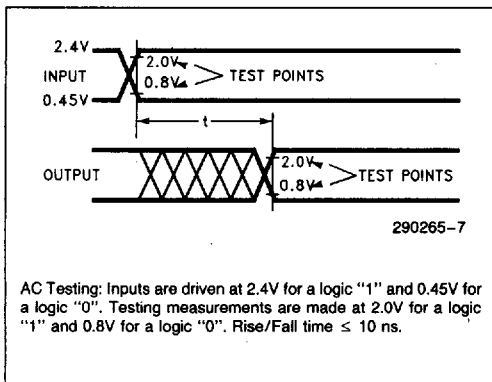

AC TESTING LOAD CIRCUIT

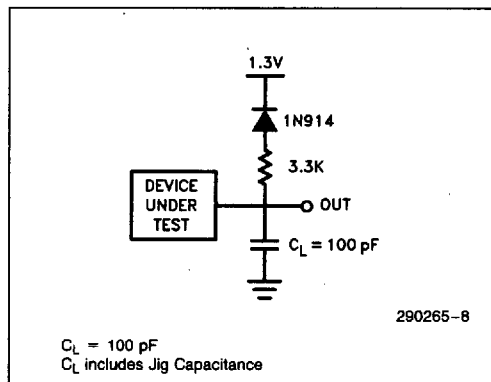

AC TEST CONDITIONS

- Input Rise and Fall Times (10% to 90%) 10 ns
- Input Pulse Levels 0.45V and 2.4V
- Input Timing Reference Level 0.8V and 2.0V
- Output Timing Reference Level 0.8V and 2.0V

AC CHARACTERISTICS—Read-Only Operations(2)

Versions		Notes	28F512-120		28F512-150		Unit
Symbol	Characteristic		Min	Max	Min	Max	
t_{AVAV}/t_{RC}	Read Cycle Time	3	120		150		ns
t_{ELQV}/t_{CE}	Chip Enable Access Time			120		150	ns
t_{AVQV}/t_{ACC}	Address Access Time			120		150	ns
t_{GLQV}/t_{OE}	Output Enable Access Time			50		55	ns
t_{ELQX}/t_{LZ}	Chip Enable to Output in Low Z	3	0		0		ns
t_{EHQZ}	Chip Disable to Output in High Z	3		50		55	ns
t_{GLQX}/t_{OLZ}	Output Enable to Output in Low Z	3	0		0		ns
t_{GHQZ}/t_{DF}	Output Disable to Output in High Z	4		30		35	ns
t_{OH}	Output Hold from Address, CE#, or OE# Change(1)	3	0		0		ns
t_{WHGL}	Write Recovery Time before Read		6		6		μ s

- NOTES:**
1. Whichever occurs first.
 2. Rise/Fall Time \leq 10 ns.
 3. Not 100% tested characterization data available.

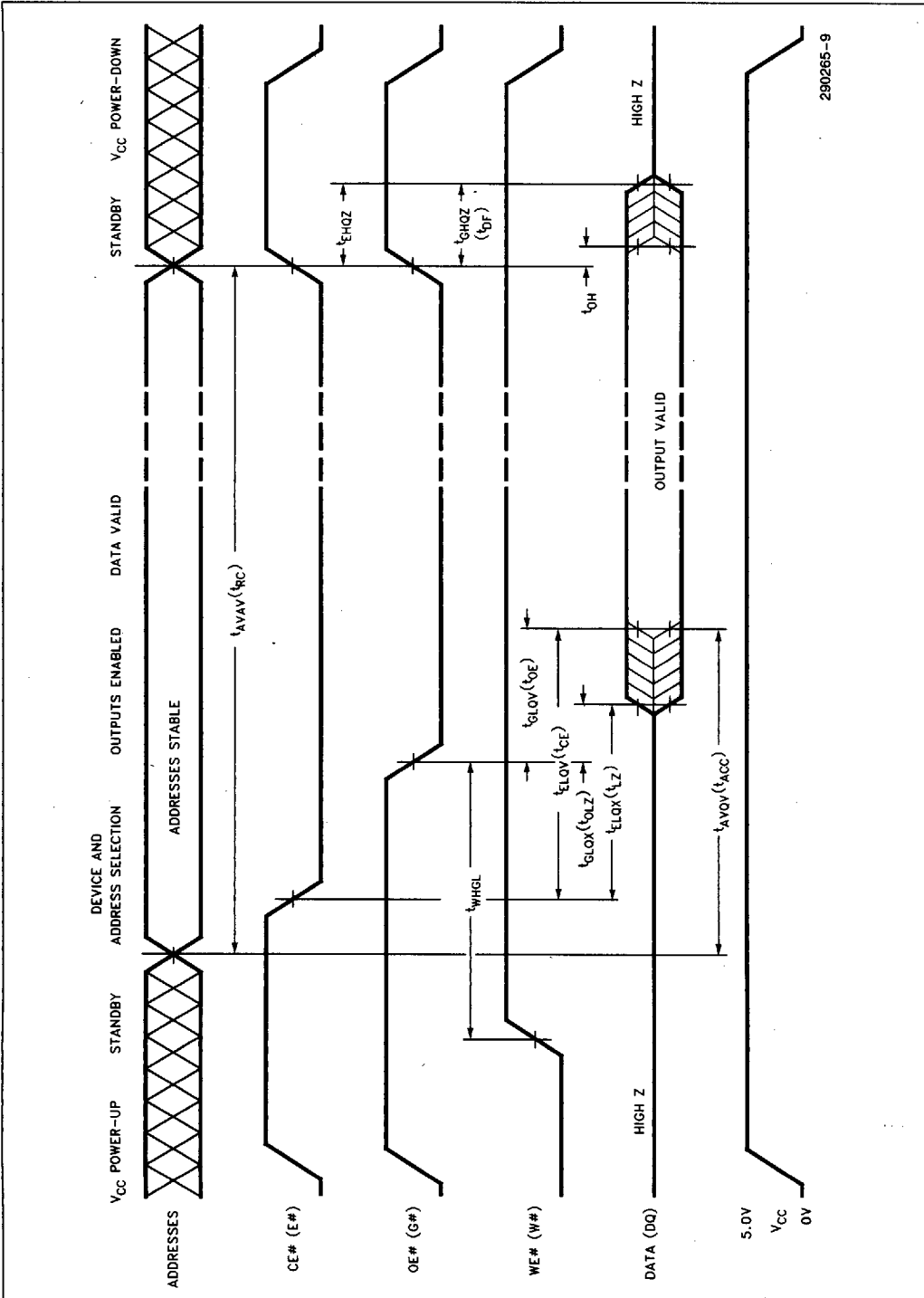

AC CHARACTERISTICS—Write/Erase/Program Operations(1, 3)

Versions		Notes	28F512-120		28F512-150		Unit
Symbol	Characteristic		Min	Max	Min	Max	
t _{AVAV} /t _{WC}	Write Cycle Time		120		150		ns
t _{AVWL} /t _{AS}	Address Set-Up Time		0		0		ns
t _{WLAX} /t _{AH}	Address Hold Time	2	60		60		ns
t _{DVWH} /t _{DS}	Data Set-up Time		50		50		ns
t _{WHDX} /t _{DH}	Data Hold Time		10		10		ns
t _{WHGL}	Write Recovery Time before Read		6		6		μs
t _{GHWL}	Read Recovery Time before Write		0		0		μs
t _{ELWL} /t _{CS}	Chip Enable Set-Up Time before Write	2	20		20		ns
t _{WEH} /t _{CH}	Chip Enable Hold Time		0		0		ns
t _{WLWH} /t _{WP}	Write Pulse Width ⁽²⁾	2	80		80		ns
t _{LEH}	Alternative Write ⁽²⁾ Pulse Width	2	80		80		ns
t _{HWL} /t _{WPH}	Write Pulse Width High		20		20		ns
t _{WHWH1}	Duration of Programming Operation	4	10		10		μs
t _{WHWH2}	Duration of Erase Operation	4	9.5		9.5		ms
t _{VPEL}	V _{pp} Set-Up Time to Chip Enable Low		1.0		1.0		ms

NOTES:

1. Read timing characteristics during read/write operations are the same as during read-only operations. Refer to AC Characteristics for Read-Only Operations.
2. Chip-Enable Controlled Writes: Write operations are driven by the valid combination of Chip-Enable and Write-Enable. In systems where Chip-Enable defines the write pulse width (within a longer Write-Enable timing waveform) all set-up, hold, and inactive Write-Enable times should be measured relative to the Chip-Enable waveform.
3. Rise/Fall time ≤ 10 ns.
4. The integrated stop timer terminates the programming/erase operations, thereby eliminating the need for a maximum specification.

ERASE AND PROGRAMMING PERFORMANCE

Parameter	Limits			Notes	Unit	Comments
	Min	Typ	Max			
Chip Erase Time		1	60	1, 3, 4, 6	Sec	Excludes 00H Programming Prior to Erasure
Chip Program Time		1	6.25	1, 2, 4	Sec	Excludes System-Level Overhead
Erase/Program Cycles	1,000	100,000		1, 5	Cycles	

NOTES:

1. "Typicals" are not guaranteed, but based on a limited number of samples taken from production lots. Data taken at T = 25°C, V_{pp} = 12.0V, V_{CC} = 5.0V.
2. Minimum byte programming time excluding system overhead is 16 μs (10 μs program + 6 μs write recovery), while maximum is 400 μs/byte (16 μs × 25 loops allowed by algorithm). Max chip programming time is specified lower than the worst case allowed by the programming algorithm since most bytes program significantly faster than the worst case byte.
3. Excludes 00H programming prior to erasure.
4. Excludes system-level overhead.

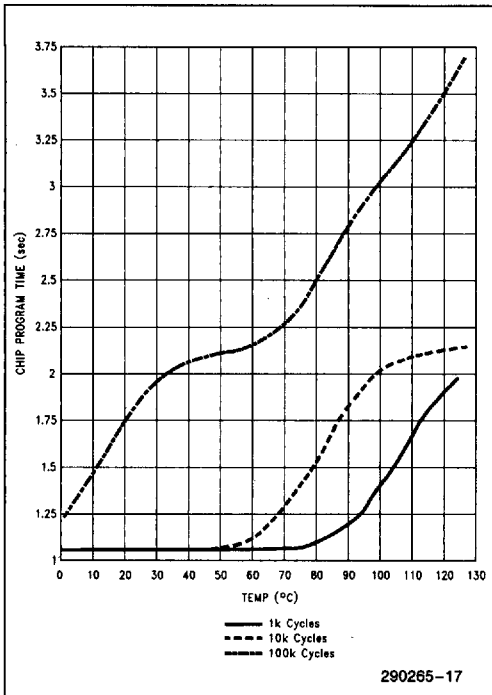

Figure 7. 28F512 Typical Program Time at 12V
See Note 1, Page 2-56.

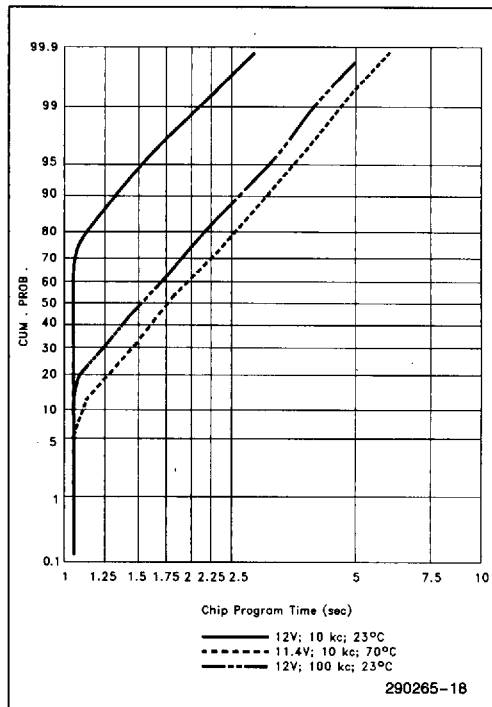

Figure 8. 28F512 Typical Programming Capability

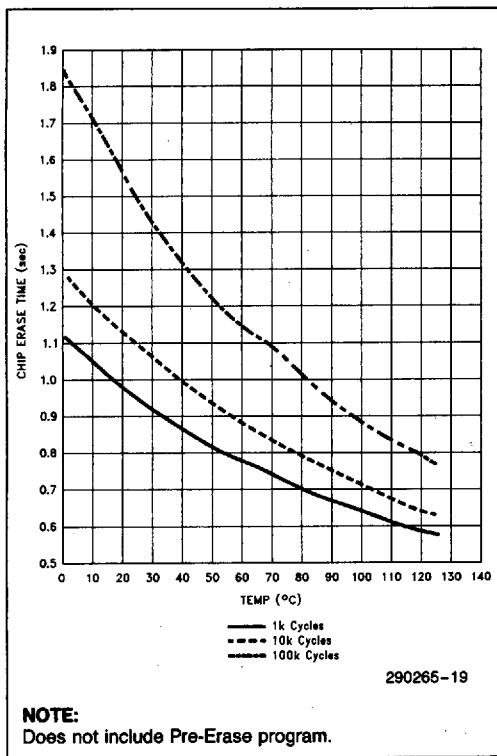

Figure 9. 28F512 Typical Erase Time at 12V
See Note 1, Page 2-56.

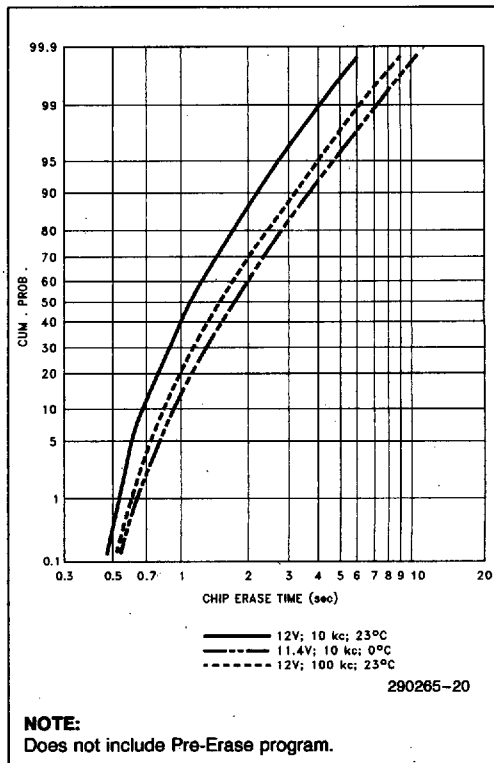
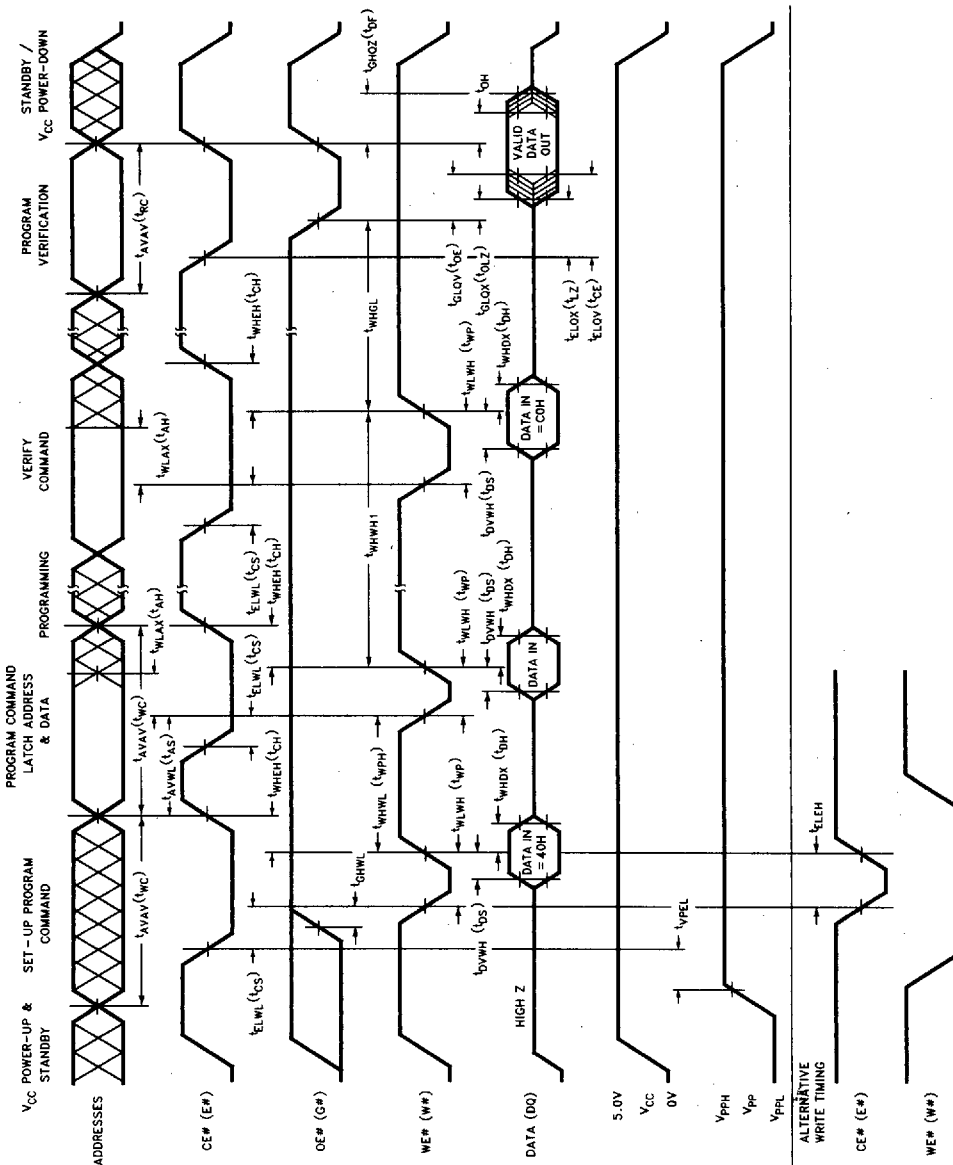
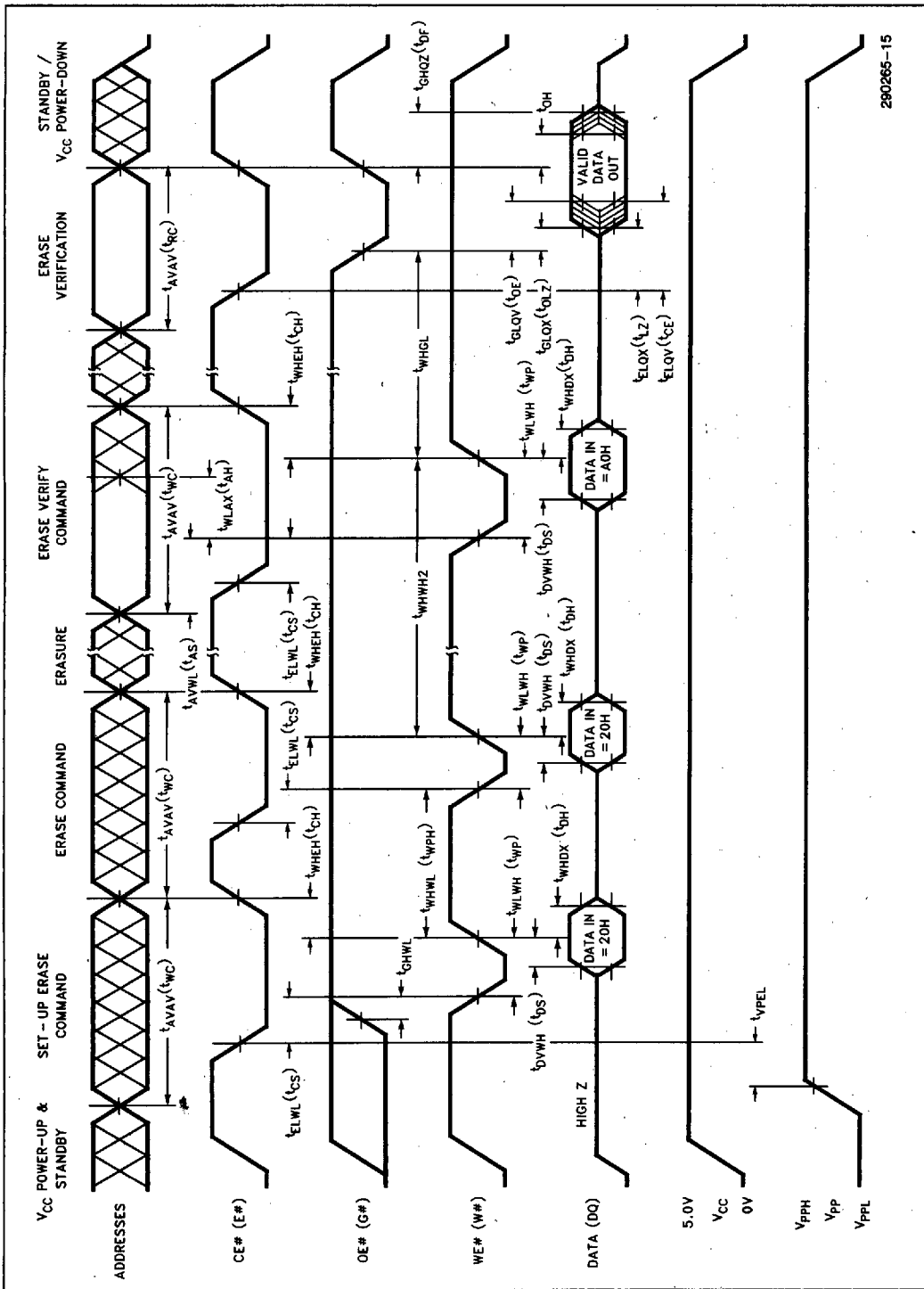

Figure 10. 28F512 Typical Erase Capability



290265-14





A28F512

Ordering Information

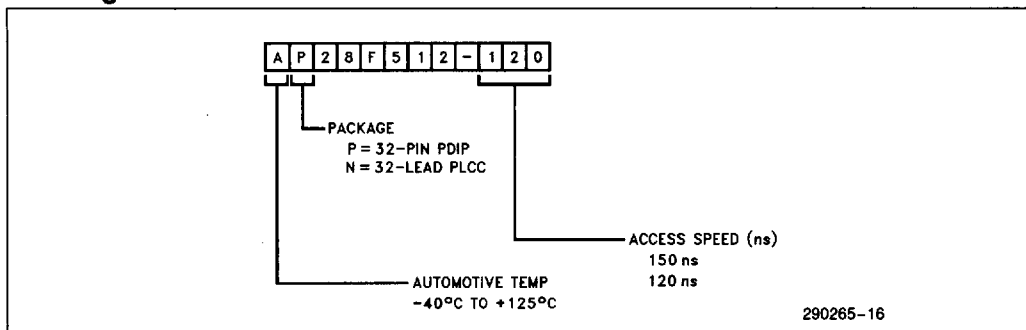

Valid Combinations:

- AP28F512-150 AN28F512-150
- AP28F512-120 AN28F512-120



ADDITIONAL INFORMATION

	Order Number
ER-20, "ETOX™ II Flash Memory Technology"	294005
ER-23, "The Intel A28F512 Flash Memory"	294007
RR-60, "ETOX™ Flash Memory Reliability Data Summary"	293002
AP-316, "Using Flash Memory for In-System Reprogrammable Nonvolatile Storage"	292046
AP-325 "Guide to Flash Memory Reprogramming"	292059

REVISION HISTORY

Number	Description
002	Changed Erase/Program Cycles to 1,000 minimum.
003	Added 120 ns speed