

ICs for VCR

Panasonic

AN3370K

Flying-Erase IC

Overview

The AN3370K can amplify high-frequency current generated by the built-in oscillator and drive the Flying-erase head. This IC also allows to set an oscillation frequency and an output current optionally with external constants according to the erase head.

Features

- Built-in high-accuracy, stable oscillator.
- Capable of varying output current value and an oscillation frequency with external constants.

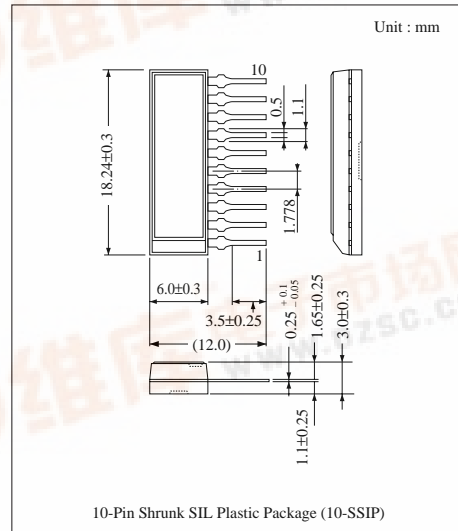

Block Diagram

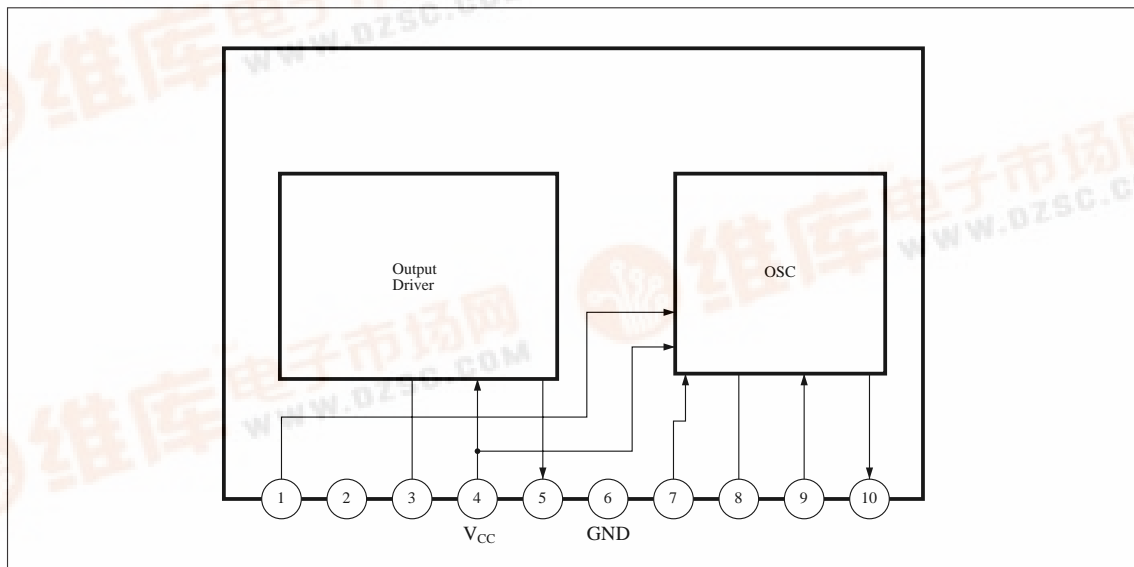

■ Absolute Maximum Ratings (Ta=25°C)

Parameter	Symbol	Rating	Unit
Supply voltage	V _{CC}	12.6	V
Power dissipation	P _D	500	mW
Operating ambient temperature	T _{opr}	- 20 to + 70	°C
Storage temperature	T _{stg}	- 55 to +150	°C

■ Recommended Operating Range (Ta = 25°C)

Parameter	Symbol	Range
Operating supply voltage range	V _{CC}	10.5V to 12.5V

■ Electrical Characteristics (V_{CC}=12V, Ta=25°C)





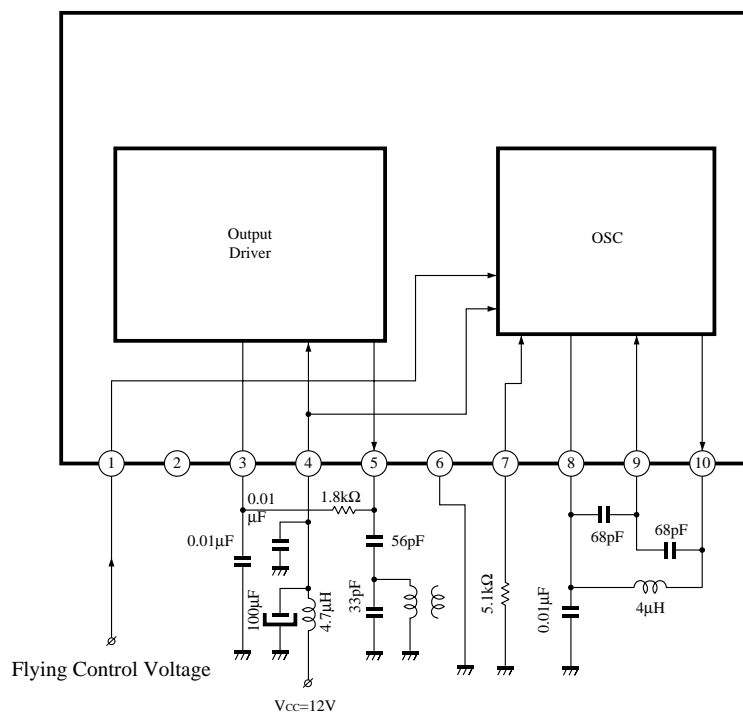



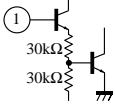

Parameter	Symbol	Condition	min	typ	max	Unit
Supply current	I _{CC}	V _i = 5V	20	28	36	mA
Oscillation output amplitude	V _{O1}	V _i = 5V, R _L = 300Ω	8	9	—	V _{PP}
Oscillation frequency	f _O	V _i = 5V, R _L = 300Ω	11	11.55	12.1	MHz
Oscillation output amplitude	V _{O2}	V _i = 0V, R _L = 300Ω	—	—	10	mV _{PP}
Flying ON	V _{IH}		3.5	—	—	V
Flying OFF	V _{IL}		—	—	0.8	V

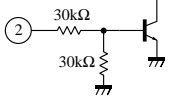
■ Application Circuit

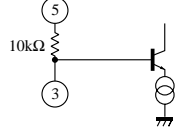

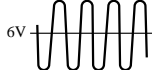
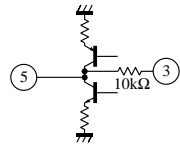
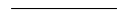
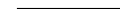
Note) Do not apply a voltage (0V included) to the Pin2 from the external.

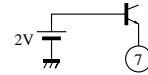
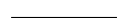
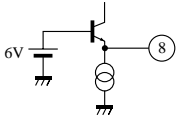
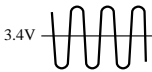
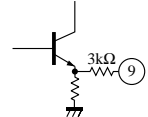
■ Pin Descriptions

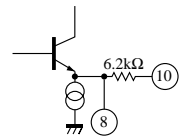
Pin No.	Pin name	Typ. waveform	Description	I/O impedance	Equivalent circuit
1	Flying erase control pin		Flying erase ON/OFF control pin. ON when 3.5V or more is applied, and OFF when 0.8V or less is applied.	3M Ω	
2			Do not apply a voltage from the external.	60k Ω	
3	Feedback pin		Feedback pin to obtain a DC voltage by filtering an output signal via an external capacitor	—	
4	Power supply		Power supply pin. Apply 12V typically from the external.	—	
5	Output pin		High-frequency current	10k Ω	
6	GND			—	
7	Oscillation input pin		It is possible to change the current which can be taken out of an output, by varying the resistor between this pin and GND.	NPN T _r emitter	
8	Reference voltage pin		Generates a reference voltage of 1/2 V _{CC} (approx. 6V)	NPN T _r emitter	
9	Oscillation feedback pin		A signal from Pin10 oscillation output is divided by the capacitor and is fed back.	3k Ω	
10	Oscillation output pin		Oscillates at the frequency determined by L, C of the Pins8, 9, 10	6.2k Ω	

■ Supplementary Explanation

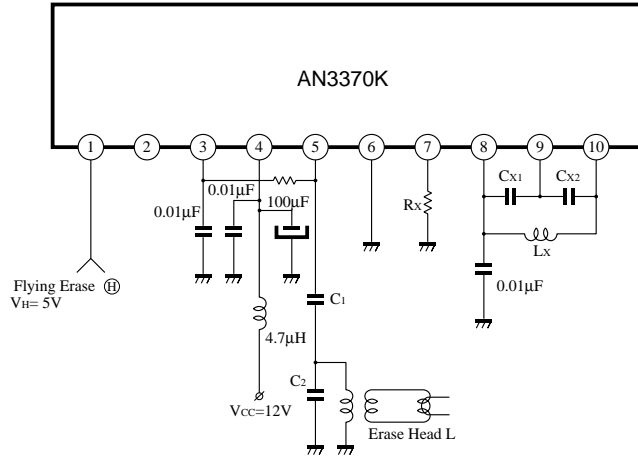

1) Internal Oscillation Frequency

An internal oscillation frequency is determined by the following expression. Set C_{X1} , C_{X2} , and L_X according to a frequency.

$$f_{osc} = \frac{1}{2\pi \sqrt{L_X \cdot \frac{C_{X1} \cdot C_{X2}}{C_{X1} + C_{X2}}}} \dots \dots \dots (1)$$

In order to obtain stable oscillation, set C_{X1}/C_{X2} near 1 and absolute value of C_{X1} , C_{X2} to such a considerable extent that an internal IC capacitance (approx. 5pF) and an external PCB capacitance can be ignored.

2) R_X

Output current amplitude from the IC is determined by the external resistor R_X of the Pin7 ; it is approximately as shown in Fig. 1. Therefore, use within the following range.

$$I_5 = 20\text{mA}_{pp} \text{ to } 65\text{mA}_{pp}$$

3) Do not apply the Pin1 voltage when V_{CC} is off.

Use the Pin2 voltage open.

4) Output Dynamic Range

Since the output pin (5) dynamic range of the AN3370K is $8V_{PP}$ (at $V_{CC}=12V$), set a combination of C_1 , C_2 , and erase head inductance (L) so that the following will be ensured.

$$I_5 (\text{mA}_{pp}) \times \text{load impedance} < 8V_{PP}$$

5) Serial and Parallel Resonance Points

- Serial resonance frequency $f_1 = \frac{1}{2\pi \sqrt{L (C_1 + C_2)}} \dots \dots \dots (2)$

Since Pin5 amplitude is minimized at a point of f_1 , set f_1 so that it will almost coincide with f_{osc} .

- Parallel resonance frequency

Suppose the internal capacitance of the Pin5 is C_5 , then parallel resonance frequency is

$$f_2 = \frac{1}{2\pi \sqrt{L \left(C_2 + \frac{C_5 \cdot C_1}{C_5 + C_1} \right)}} \dots \dots (3)$$

Although an erase head current is maximized at this point, set $f_2/f_{osc} \approx 1.25$ to 1.4

• Characteristic Curve

