

AN3861SA

Sensor-less Motor Drive IC for VTR Movie Cylinder

Overview

The AN3861SA is a sensor-less motor drive IC for VTR movie cylinder. It uses both sensor-less and sine wave drive, thus excellent for low-noise applications.

Features

- Operating supply voltage range : $V_{CC}=3.0$ to $5.5V$, $V_B=4.0$ to $10.5V$
- Reduced magnetosound using 3-phase full-wave overlap drive. Built-in power transistor.
- Standby mode for minimizing power consumption
- Voltage output for controlling SW power supply
- Motor neutral point input terminal

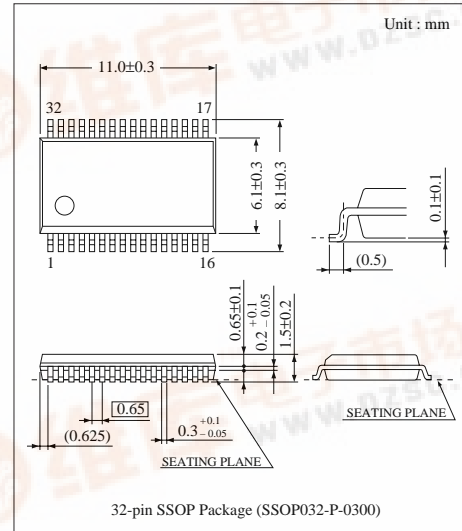

Pin Descriptions

Pin No.	Symbol	Description	Pin No.	Symbol	Description
1	U	U-phase drive output terminal	17	V_{CC}	Power supply terminal
2	CS	Drive current output terminal	18	IN2H	Operational amplifier 2 input terminal
3	VSC	Switching power supply control output terminal	19	OUT2	Operational amplifier 2 output terminal
4	WIN	W-phase detection terminal	20	IN1 ₋	Operational amplifier 1 reverse phase input terminal
5	VIN	V-phase detection terminal	21	IN1 ₊	Operational amplifier 1 normal phase input terminal
6	UIN	U-phase detection terminal	22	MM	Motor neutral point input terminal
7	PCV	Voltage feedback system compensation terminal	23	OUT1	Operational amplifier 1 output terminal
8	SG	Signal ground	24	V_{ref}	Servo reference voltage input terminal
9	SL3	Slope waveform generate terminal (3)	25	PCI	Current feedback system phase compensation terminal
10	SL2	Slope waveform generate terminal (2)	26	VS	Motor drive power supply terminal
11	SL1	Slope waveform generate terminal (1)	27	VB	Unregulated power supply terminal
12	FC	Oscillation terminal	28	CS	Drive current output terminal
13	BR	Short brake control terminal	29	W	W-phase drive output terminal
14	FR	Forward/Reverse change-over terminal	30	PG	Power ground
15	HSL	Slope current change-over terminal	31	V	V-phase drive output terminal
16	STB	Stand-by input terminal	32	PG	Power ground

■ Block Diagram

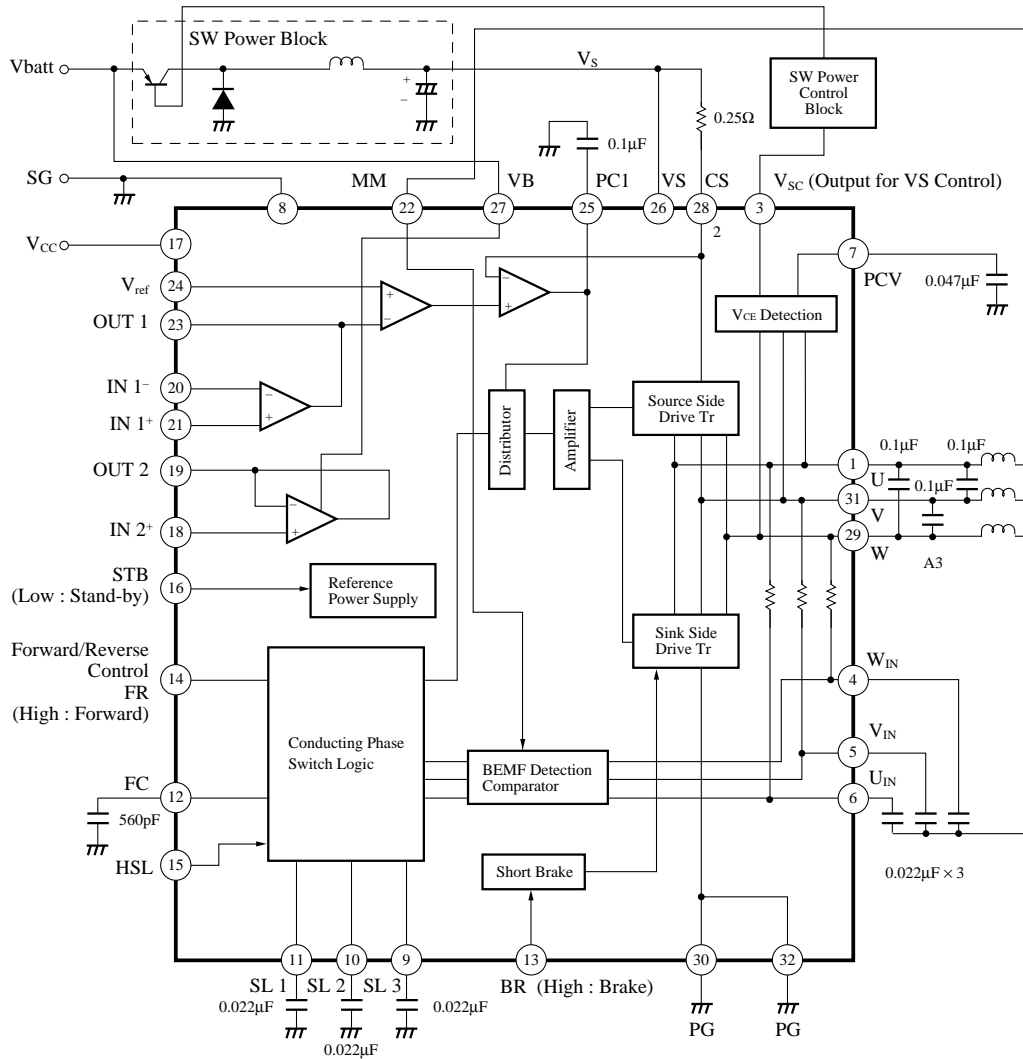

Note) Values of all external C and R are nominal one.

■ Absolute Maximum Rating (Ta=25°C)

Parameter	Symbol	Rating	Unit
Supply voltage	V _{CC}	6.0	V
Unregulated voltage	V _B	11	V
Motor power supply voltage (under V _B)	V _S	11	V
Output terminal voltage n=1, 29, 31	V _n	11	V
Output current n=1, 29, 31	I _{On}	1000	mA
Power dissipation ^{Note 1)}	P _D	400	mW
Operating ambient temperature	T _{opr}	-25 to +70	°C
Storage temperature	T _{stg}	-55 to +150	°C

Note 1) Package power dissipation when Ta=75°C

■ Recommended Operating Range (Ta=25°C)

Parameter	Symbol	Range
Operating supply voltage	V _{CC}	3.0V to 5.5V
	V _B	4.0V to 10.5V
	V _S	1.5V to V _B

■ Package Power Dissipation

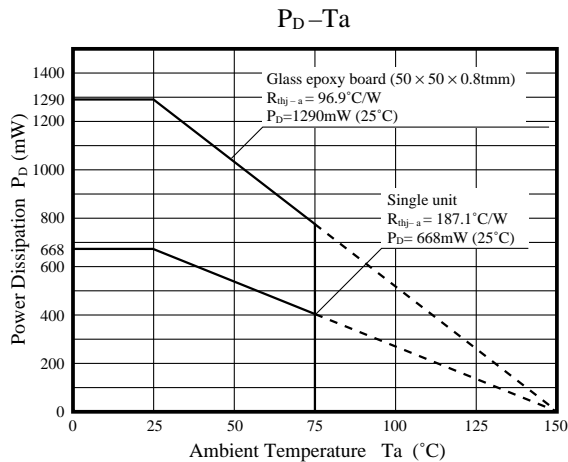

■ Electrical Characteristics (V_{CC}=3.3V, V_B=6V, V_S=6V, Ta=25±2°C)

Parameter	Symbol	Condition	min	typ	max	Unit
Drive Block						
Drive gain	G _{io}	$\frac{\Delta V_{CS}}{\Delta OUT1}$	0.11	0.14	0.17	
Drive amplifier offset	V _{iOCS}	Input offset voltage of V _{ref} and OUT1	-100	6	100	mV
Output maximum current	I _{Omax}	R _{CS} =0.25Ω	625	750	875	mA
Brake current	IBR		200	500	—	mA
Sink-side output voltage	V _{CE}	I _O =100mA	0.15	0.25	0.35	V
Sink-side saturation voltage	V _{SAT(1)}	I _O =500mA	—	0.25	0.35	V
Source-side saturation voltage	V _{SAT(2)}	I _O =500mA	—	0.90	1.3	V
Bemf Detection Block						
Comparator hysteresis width	V _{HCOM}		4	16	29	mV

■ Electrical Characteristics (cont.) ($V_{CC}=3.3V$, $V_B=6V$, $V_S=6V$, $T_a=25\pm 2^\circ C$)







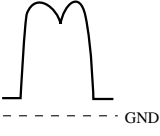
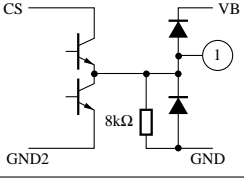

Parameter	Symbol	Condition	min	typ	max	Unit
Oscillator						
Triangular wave oscillation frequency	f_{FC}	$C_{FC}=560pF$	11.0	16.3	22.8	kHz
Slope						
Slope terminal charging current (1)	$I_{SLC(1)}$	HSL : L $C_{FC}=560pF$ femf < 160Hz	-26	-20	-14	μA
Slope terminal discharging current (1)	$I_{SLD(1)}$		14	20	26	μA
Slope terminal charging current (2)	$I_{SLC(2)}$	HSL : L $C_{FC}=560pF$ femf > 181Hz	-52	-40	-28	μA
Slope terminal discharging current (2)	$I_{SLD(2)}$		28	40	52	μA
Slope terminal charging current (3)	$I_{SLC(3)}$	HSL : H $C_{FC}=560pF$ femf < 160Hz	-52	-40	-28	μA
Slope terminal discharging current (3)	$I_{SLD(3)}$		28	40	52	μA
Slope terminal charging current (4)	$I_{SLC(4)}$	HSL : H $C_{FC}=560pF$ femf > 181Hz	-78	-60	-42	μA
Slope terminal discharging current (4)	$I_{SLD(4)}$		42	60	78	μA
Operational Amp. 1 only						
Common-mode input voltage range	$V_{ICR(1)}$		0.2	—	$V_B-1.4$ or V_{CC}	V
Input offset current	I_{IOAI}		-50	5	50	nA
Voltage gain	G_{AI}		60	67	—	dB
Output sink current (1)	$I_{OS1(1)}$	OUT1=0.2V	20	140	—	μA
Operational Amp. 2 only						
Common-mode input voltage range	$V_{ICR(2)}$		0	—	$V_B-1.4$	V
Operational Amp. 1 and 2						
Input offset voltage	$V_{IOA1,2}$		-20	-3	20	mV
Output sink current 1- (2)	$I_{OS1(2)}$		1.8	4	—	mA
Output sink current 2- (2)	$I_{OS2(2)}$		2	4	—	mA
Output source current (2)	$I_{OSA 1,2}$		—	-15	-2	mA
Mode Switch=HSL, STB, FR, BR						
Input high level	V_{SWH}		2.0	—	—	V
Input low level	V_{SWL}		—	—	0.6	V
Input bias current	I_{BSW}	$V_{SW}=2V$	—	25	100	μA
Motor Power Supply Control						
Input/output gain	G_{IOS}	$\frac{\Delta V_{SC}}{\Delta U}$	1.4	2.0	2.6	Times
Output impedance	Z_{OS}		12	18	24	k Ω
Operation point (1)	$V_{S-U(1)}$	V_{S-U} for $V_{SC}=1.6V$ when $OUT1=V_{ref}$	0.1	0.35	0.6	V
Operation point (2)	$V_{S-U(2)}$	V_{S-U} for $V_{SC}=1.6V$ when $OUT1=V_{ref} + 1$	0.35	0.63	0.9	V
Power Supply Current						
Operating power supply current	$I_{CC(1)}$	STB : H	—	10	15	mA
STB power supply current	$I_{CC(2)}$	STB : L	—	6	10	mA
Unregulated power supply current (1)	$I_{BB(1)}$	$V_{CC}=0V$	—	0.1	10	μA
Unregulated power supply current (2)	$I_{BB(2)}$	$V_{CC}=3.3V$, $I_{n2}^+=0V$	—	0.3	1.5	mA

■ Electrical Characteristics [Reference Values] ($T_a=25\pm 2^\circ C$)

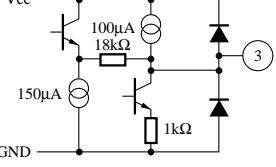
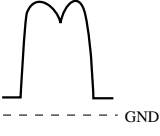
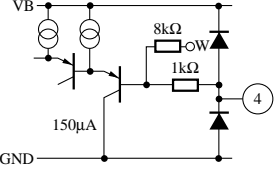

This is design reference value, and not guaranteed one.

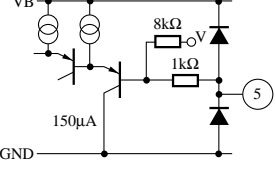
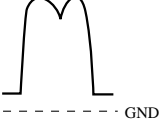
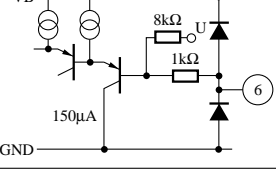
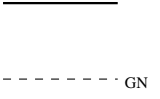
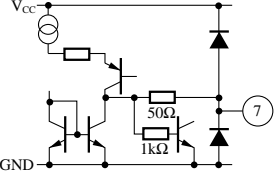
Parameter	Symbol	Condition	Reference value	Unit
Thermal protection circuit operation temperature	T_{SD}	$V_{CC}=3.3V$	175	$^\circ C$

Pin Descriptions

Pin No.	Pin name	Standard waveform	Description	Equivalent circuit
1	U : U-phase drive output		Terminal driving the U-phase of motor	
2	CS : Drive power supply output		Terminal outputting the drive current of motor	
3	VSC : Switching power supply control output		Terminal outputting the control voltage of the switching power supply	
4	WIN : W-phase detection		Terminal detecting the W-phase	
5	VIN : V-phase detection		Terminal detecting the V-phase	
6	UIN : U-phase detection		Terminal detecting the U-phase	
7	PCV : Voltage feedback system phase compensation		Terminal attaching the capacitor for phase compensation of the voltage feedback system	
8	SG : Signal ground		Grounding terminal for signal system	

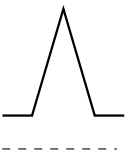
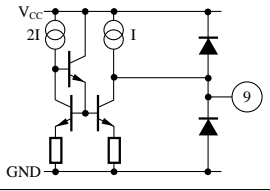
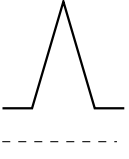
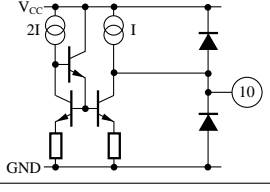
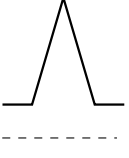
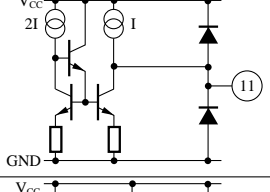

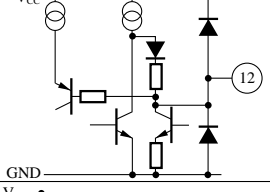
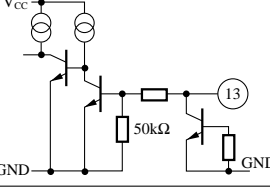
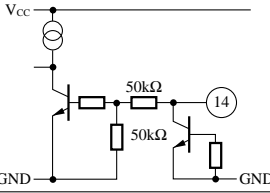
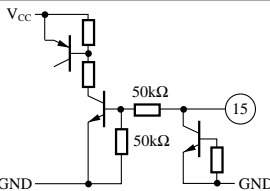
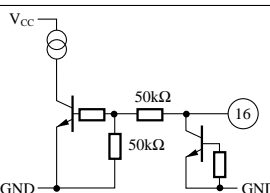





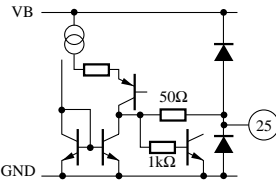

■ Pin Descriptions (cont.)

Pin No.	Pin name	Standard waveform	Description	Equivalent circuit
9	SL3 : Slope waveform generation (3)		Terminal generating the waveform of the motor drive current	
10	SL2 : Slope waveform generation (2)		Terminal generating the waveform of the motor drive current	
11	SL1 : Slope waveform generation (1)		Terminal generating the waveform of the motor drive current	
12	FC : Oscillation		Terminal determining the phase switching frequency at motor start	
13	BR : Short brake control	V _{CC} or GND	Terminal controlling the short brake	
14	FR : Forward/Reverse switching terminal	V _{CC} or GND	Terminal switching the normal/reverse rotation of motor	
15	HSL : Slope current control terminal	V _{CC} or GND	Terminal controls the charging/discharging current of the slope waveform generating terminal	
16	STB : Stand-by input	V _{CC} or GND	Terminal controls the operation/stand-by condition	

■ Pin Descriptions (cont.)

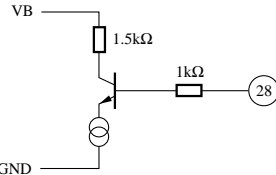
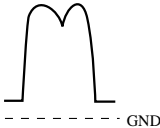
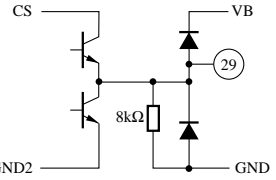
Pin No.	Pin name	Standard waveform	Description	Equivalent circuit
17	V _{CC} : Power supply		Terminal inputting the V _{CC} power supply	
18	IN2H : Operational amp. 2 input		Input terminal for operational amp. 2	
19	OUT2 : Operational amp. 2 output		Output terminal for operational amp. 2	
20	IN1- : Operational amp. 1 reverse phase input		Terminal inputting the reverse phase voltage of operational amp. 1	
21	IN1+ : Operational amp. 1 normal phase input		Terminal inputting the normal phase voltage of operational amp. 1	
22	MM : Motor neutral point input terminal		Terminal inputting the motor neutral point	
23	OUT1 : Operational amp. 1 output		Terminal outputting the output voltage of operational amp. 1	
24	V _{ref} : Servo reference voltage input		Terminal inputting the servo reference voltage	

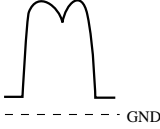
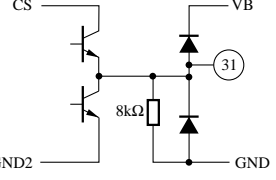
■ Pin Descriptions (cont.)

Pin No.	Pin name	Standard waveform	Description	Equivalent circuit
25	PCI : Current feedback system phase compensation		Terminal attaching the capacitor for phase compensation of current feedback system	
26	VS : Motor drive power supply		Terminal inputting the VS motor drive power supply	
27	VB : Unregulated power supply		Terminal inputting the VB unregulated power supply	
28	CS : Drive current output		Terminal outputting the motor drive current	
29	W : W-phase drive output		Terminal driving the W-phase of motor	
30	PG : Power block grounding		Terminal connecting the power transistor block to GND	
31	V : V-phase drive output		Terminal driving the V-phase of motor	
32	PG : Power block grounding		Terminal connecting the power transistor block to GND	

■ Operation Descriptions

(1) STB terminal

The operating condition of the IC internal circuit is shown in the following table :

STB input	Condition of the IC internal circuit
L ^{Note)}	AMP2 and sensor-less block only operating
H	All circuit operating

Note) Since the sensor-less block operates, if the motor rotates, it detects the inductive voltage and synthesizes the energization switching signal which is synchronized with the motor rotation phase.

(2) FR, BR terminal

FR terminal H : Forward rotation

L : Reverse rotation

BR terminal H : Short brake circuit operation

L : Short brake circuit stop

(3) Drive amplifier

The AN3861SA is an IC of current drive type, and the motor drive current I_a is determined by the voltage of OUT1 terminal, as shown in Fig.1.

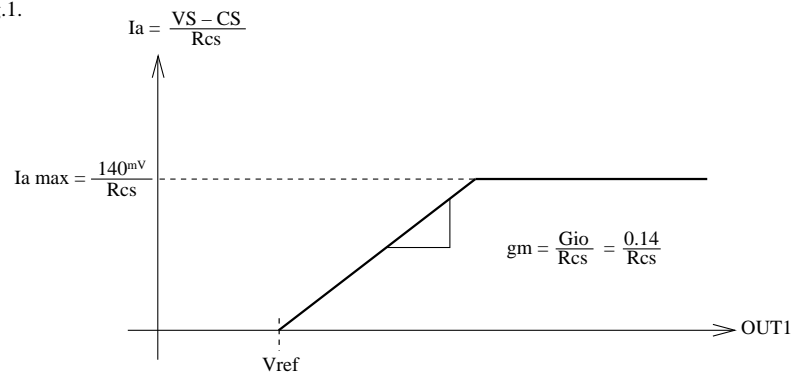

Fig.1 Drive Characteristics

The collector voltage value is controlled as shown in Fig.2 since the sink-side output transistor is operated with non-saturation voltage.

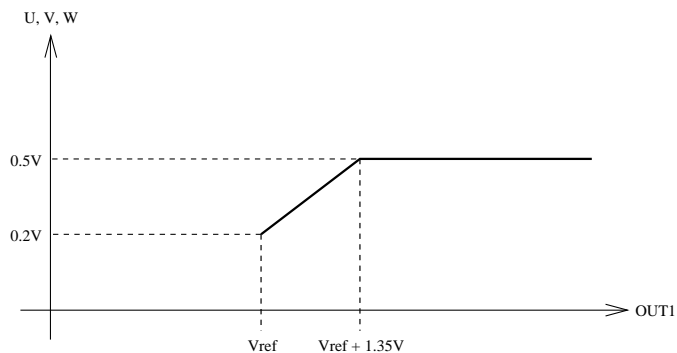

Fig.2 OUT1 and V_{CE} of Sink-side Output Transistor

(4) VCS terminal

For the AN3861SA, since the collector voltage of the sink-side output transistor is controlled to a certain value. Therefore, when the V_B is high enough, extra voltage is applied to the V_{CE} of source side output transistor. This loss voltage of V_{CE} can be reduced by the VSC voltage through the circuit as shown in the following figure.

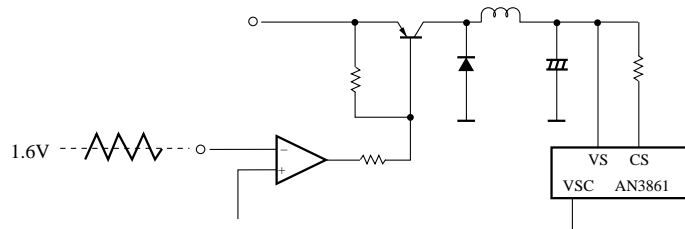

Fig.3 Switching Regulator System with VSC Terminal

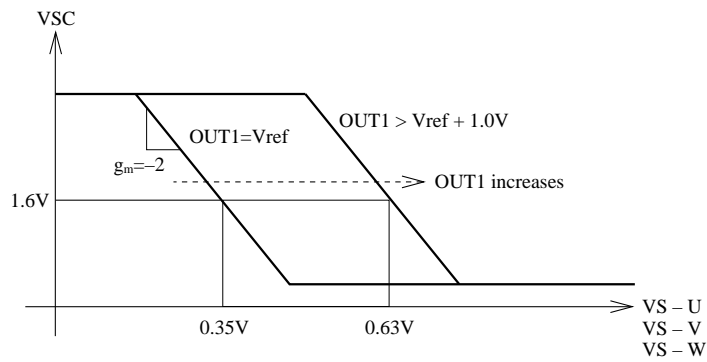

Fig.4 VSC Characteristics

(5) FC terminal

This is an oscillation terminal which determines the commutation frequency at operation start and the frequency f_{emf} of inductive voltage for switching over the charging/discharging current of the SL terminal (Refer to (6) below). Normally, $f_{FC}=16.3\text{kHz}$ when $C_{FC}=560\text{pF}$ and the frequency at operation start is approx. 4Hz.

(6) SL1, SL2, SL3 terminal

The SL1, SL2 and SL3 are terminals producing the slope waveform for synthesizing the trapezoidal wave current. Since the slope waveform is synthesized by charging/discharging the external capacitor with the constant current, the amplitude VSL becomes as follows :

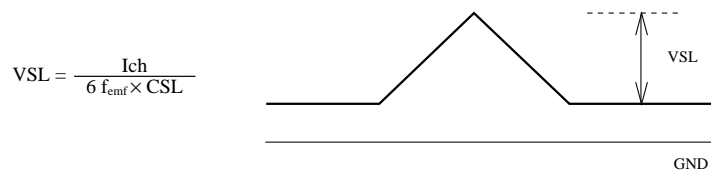

Fig.5 Waveform of SL1, SL2 and SL3

Where, I_{ch} : Charging/Discharging current

CSL : Capacitance value

f_{emf} : Frequency of motor inductive voltage

The value of I_{ch} is changed according to the relationship between the frequency of the motor inductive voltage and the oscillation frequency of the FC terminal, as shown in Fig.6 in the next page. Therefore, the capacitance value of external capacitor CSL should be selected so that the value of VSL could fall in the range from 0.5 to 1.5V during constant rotation.

Since the relative dispersion of three external capacitors may cause increase of motor noise, the capacitor with high accuracy should be used.

(7) Capacitance value of U_{in} , V_{in} , W_{in}

The capacitor of U_{in} , V_{in} and W_{in} prevents the malfunction of the comparator due to spike-shaped voltage which is generated in the motor coil at operation start. For this reason, it should be used as necessary for large motor of large L such as winding coil.