

AN48800A

Low current consumption, high sensitivity CMOS Hall IC
One-way magnetic field operation

Overview

The AN48800A is a Hall IC (a magnetic sensor) which has 2 times or more sensitivity and a low current consumption of about one three-hundredth compared with our conventional one.

In this Hall IC, a Hall element, a offset cancel circuit, an amplifier circuit, a sample and hold circuit, a Schmidt circuit, and output stage FET are integrated on a single chip housed in a small package by IC technique.

Features

- High sensitivity (6 mT max.) due to offset cancel circuit and a new sample and hold circuit
- Small current by using intermittent action (10 μ A typ.)
- Small package (SMD)
- Open drain output

Applications

- Flip type cellular phone, digital video camera

Block Diagram

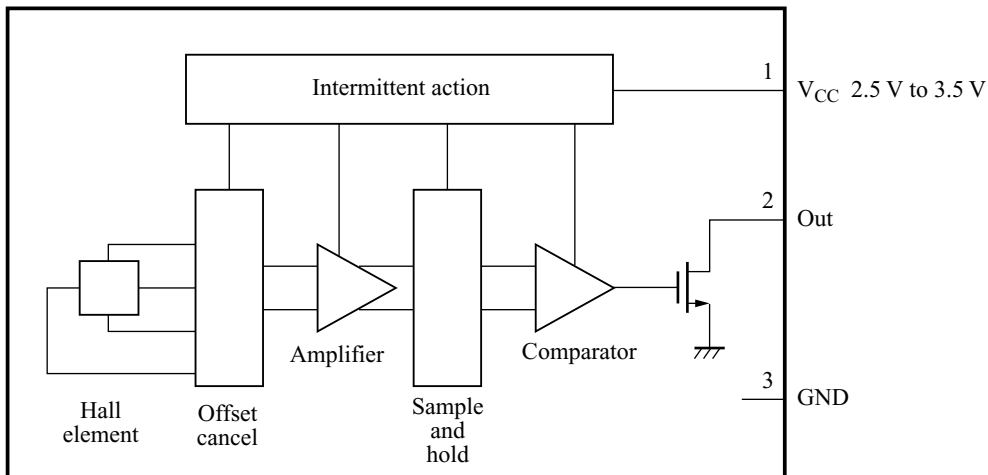

Note) The magnetism detection time should be longer than one intermittent action cycle (On = 200 μ s and Off = 51 ms).

Pin Descriptions

Pin No.	Symbol	Description
1	V _{CC}	Power supply
2	Out	Output
3	GND	Ground

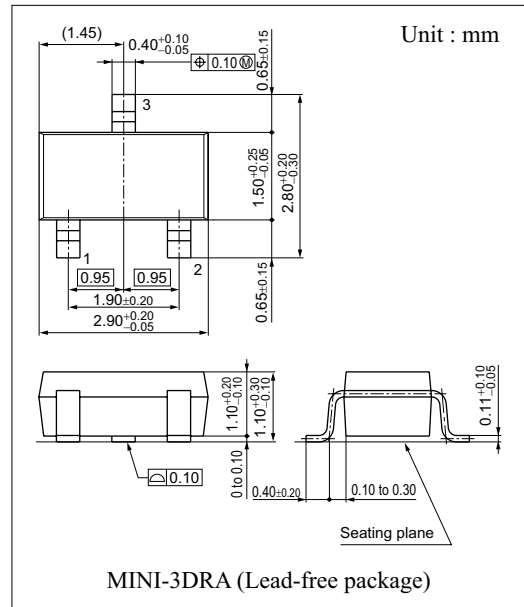

■ Absolute Maximum Ratings

Parameter	Symbol	Rating	Unit
Supply voltage	V_{CC}	5	V
Output voltage	V_{OUT}	5	V
Supply current	I_{CC}	5	mA
Output current	I_{OUT}	30	mA
Power dissipation *1,*2	P_D	60	mW
Operating ambient temperature *1	T_{opr}	-20 to +75	°C
Storage temperature *1	T_{stg}	-55 to +125	°C

Note) *1: Except for the power dissipation, operating ambient temperature and storage temperature, all ratings are for $T_a = 25^\circ\text{C}$.

*2: $T_a = 75^\circ\text{C}$. For the independent IC without a heat sink. Please use within the range of power dissipation, referring to $P_D - T_a$ curve.

■ Recommended Operating Range

Parameter	Symbol	Range	Unit
Supply voltage	V_{CC}	2.5 to 3.5	V

■ Electrical Characteristics $T_a = 25^\circ\text{C} \pm 2^\circ\text{C}$

Parameter	Symbol	Conditions	Min	Typ	Max	Unit
Operating magnetic flux density 1 *1	B_{H-L}	$V_{CC} = 3\text{ V}$	—	—	6	mT
Operating magnetic flux density 2 *2	B_{L-H}	$V_{CC} = 3\text{ V}$	0.5	—	—	mT
Output voltage	V_{OL}	$V_{CC} = 3\text{ V}, I_O = 5\text{ mA}, B = 6.0\text{ mT}$	—	0.1	0.3	V
Output current	I_{OH}	$V_{CC} = 3\text{ V}, V_O = 3\text{ V}, B = 0.5\text{ mT}$	—	—	10	μA
Supply current 1 *3	I_{CCAVE}	$V_{CC} = 3\text{ V}, B = 0.5\text{ mT}$	—	10	15	μA

Note) *1: Symbol B_{H-L} stands for the operating magnetic flux density where its output level varies from high to low.

*2: Symbol B_{L-H} stands for the operating magnetic flux density where its output level varies from low to high.

*3: $I_{CCAVE} = \{I_{CCON} \times t_{ON} + I_{CCOFF} \times t_{OFF}\} / \{t_{ON} + t_{OFF}\}$

• Design reference data

Parameter	Symbol	Conditions	Min	Typ	Max	Unit
Hysteresis width 1	BW	$V_{CC} = 3\text{ V}$	—	1.2	—	mT
Supply current 2	I_{CCON}	$V_{CC} = 3\text{ V}, B = 0.5\text{ mT}$	—	2	—	mA
Supply current 3	I_{CCOFF}	$V_{CC} = 3\text{ V}, B = 0.5\text{ mT}$	—	3	—	μA
Operating time	t_{ON}	$V_{CC} = 3\text{ V}$	—	200	—	μs
Stop time	t_{OFF}	$V_{CC} = 3\text{ V}$	—	51	—	ms

Note) It will operate normally in approximately 51 ms after power on.

Individual Specification

■ Technical Data

- Position of a Hall element (unit in mm)

Distance from a package surface to sensor part: 0.39 mm (reference value)

A Hall element is placed on the shaded part in the figure.

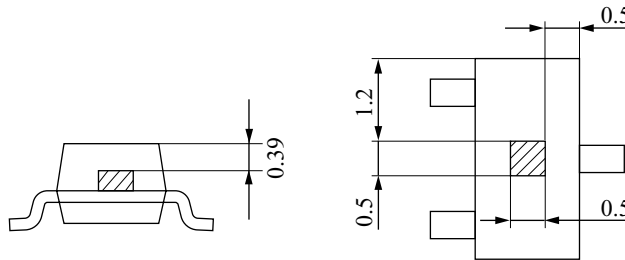

- Magneto-electro conversion characteristics

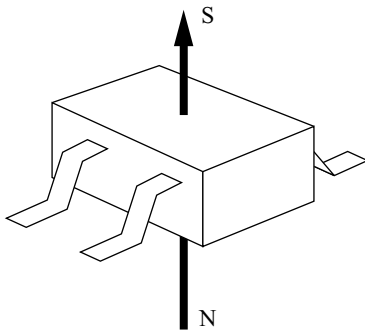

Direction of applied magnetic field

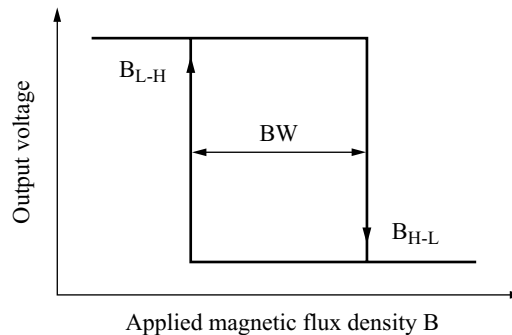

Operating magnetic flux density

- Simple polarity distinction method of mounting magnet to product incorporating Hall IC

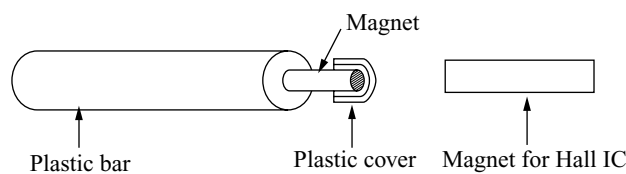

A magnet, which is used in pair with a Hall IC, can be mounted to a product incorporating a built-in Hall IC (e.g., a cellular phone) smoothly and correctly with a simple tool. The polarity of the magnet (hereafter referred to as Hall IC magnet) will be automatically discriminated.

This tool is a plastic bar, one end of which is attached with a small magnet (hereafter referred to as plastic bar magnet), as shown in the above illustration. The plastic bar magnet, the polarity of which is known, is secured on the bar with a plastic cover. When the plastic bar magnet is located close to the Hall IC magnet, the Hall IC magnet will be attracted to the plastic bar magnet. The contact side of the Hall IC magnet is different in polarity from that of the plastic bar magnet. As a matter of course, the polarity of the Hall IC magnet will be known then. The Hall IC magnet can be mounted to the appliance in this state. The attraction force of the plastic bar magnet is rather weak due to the plastic cover on it. Therefore, the plastic bar can be separated from the Hall IC magnet with ease after the Hall IC magnet is mounted properly.

■ Technical Data (continued)

• Main characteristics

Operating magnetic flux density — Supply voltage

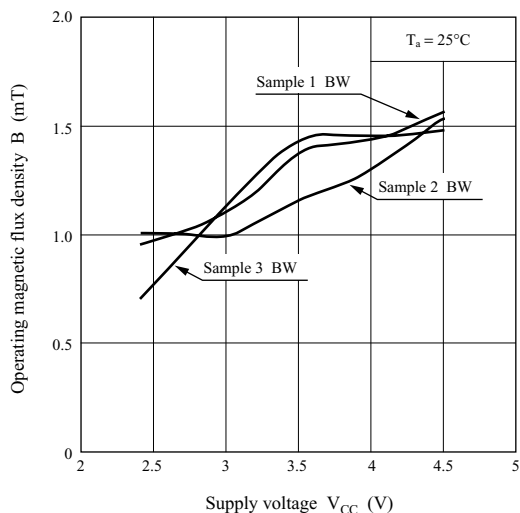

Operating magnetic flux density — Ambient temperature

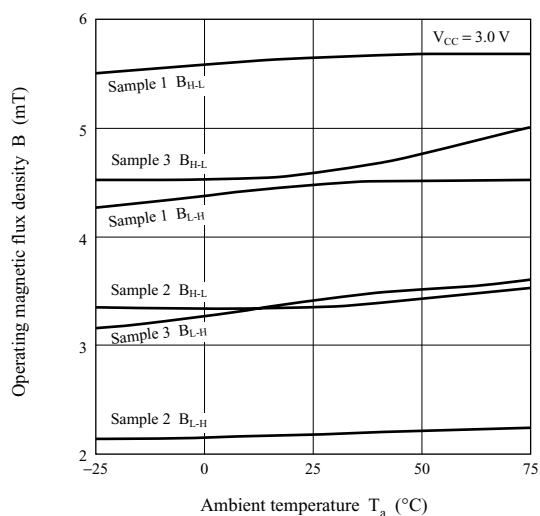

Operating magnetic flux density — Supply voltage

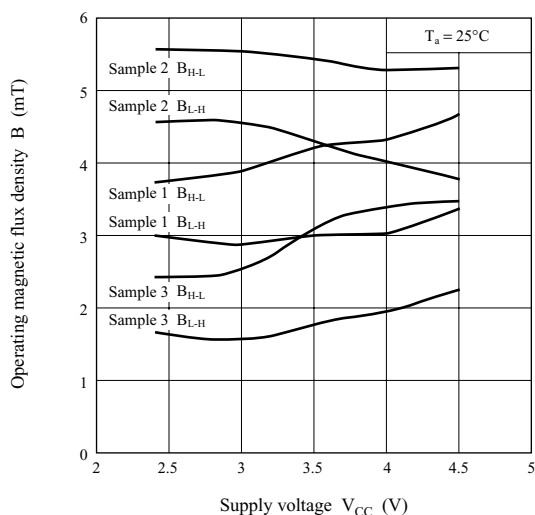

Average consumption current — Supply voltage

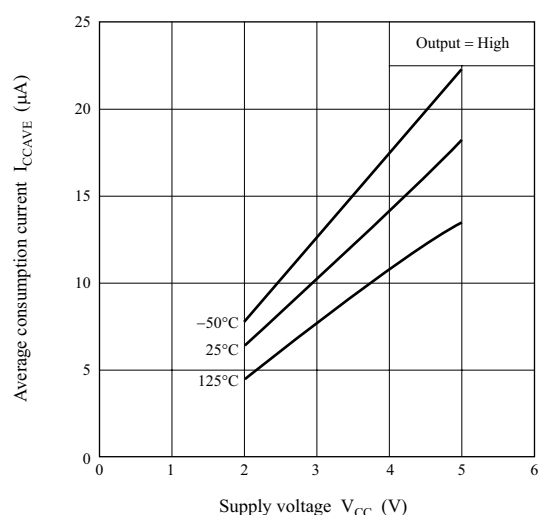

Low-level output voltage — Supply voltage

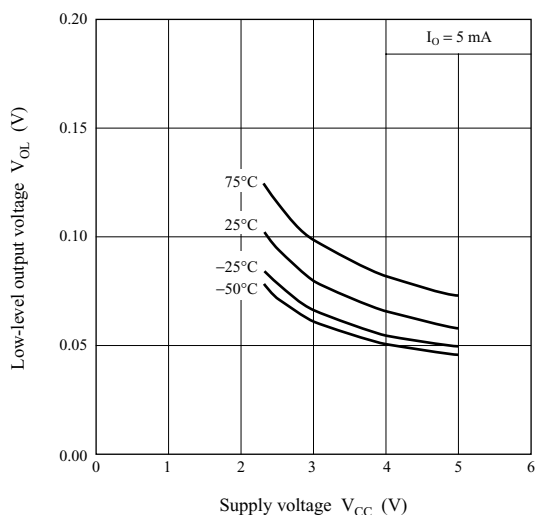

Low-level output voltage — Ambient temperature

