



July 2001

# AO4701

## P-Channel Enhancement Mode Field Effect Transistor with Schottky Diode

### General Description

The AO4701 uses advanced trench technology to provide excellent  $R_{DS(ON)}$  and low gate charge. A Schottky diode is provided to facilitate the implementation of a bidirectional blocking switch.

### Features

- $V_{DS}$  (V) = -30V
- $I_D$  = -5A
- $R_{DS(ON)} < 49m\Omega$  ( $V_{GS} = 10V$ )
- $R_{DS(ON)} < 64m\Omega$  ( $V_{GS} = 4.5V$ )
- $R_{DS(ON)} < 120m\Omega$  ( $V_{GS} = 2.5V$ )

### SCHOTTKY

$V_{DS}$  (V) = 30V,  $I_F$  = 3A,  $V_F=0.5V@1A$

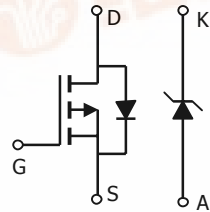
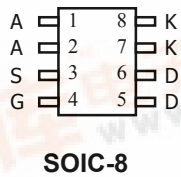

### Absolute Maximum Ratings $T_A=25^\circ C$ unless otherwise noted

Parameter	Symbol	MOSFET	Schottky	Units
Drain-Source Voltage	$V_{DS}$	-30		V
Gate-Source Voltage	$V_{GS}$	$\pm 12$		V
Continuous Drain Current <sup>A</sup>	$I_D$	$T_A=25^\circ C$	-5	A
		$T_A=70^\circ C$	-4.2	
Pulsed Drain Current <sup>B</sup>	$I_{DM}$	-30		
Schottky reverse voltage	$V_{KA}$		30	V
Continuous Forward Current <sup>A</sup>	$I_F$	$T_A=25^\circ C$	4.4	A
		$T_A=70^\circ C$	3.2	
Pulsed Forward Current <sup>B</sup>	$I_{FM}$		30	
Power Dissipation	$P_D$	$T_A=25^\circ C$	2	W
		$T_A=70^\circ C$	1.44	
Junction and Storage Temperature Range	$T_J, T_{STG}$	-55 to 150	-55 to 150	$^\circ C$

Parameter: Thermal Characteristics MOSFET		Symbol	Typ	Max	Units
Maximum Junction-to-Ambient <sup>A</sup>	$t \leq 10s$	$R_{\theta JA}$	48	62.5	$^\circ C/W$
Maximum Junction-to-Ambient <sup>A</sup>	Steady-State		74	110	
Maximum Junction-to-Lead <sup>C</sup>	Steady-State	$R_{\theta JL}$	35	40	
Thermal Characteristics Schottky					
Maximum Junction-to-Ambient <sup>A</sup>	$t \leq 10s$	$R_{\theta JA}$	49	62.5	$^\circ C/W$
Maximum Junction-to-Ambient <sup>A</sup>	Steady-State		72	110	
Maximum Junction-to-Lead <sup>C</sup>	Steady-State	$R_{\theta JL}$	37	42	

Electrical Characteristics (T<sub>J</sub>=25°C unless otherwise noted)

Symbol	Parameter	Conditions	Min	Typ	Max	Units
<b>STATIC PARAMETERS</b>						
BV <sub>DSS</sub>	Drain-Source Breakdown Voltage	I <sub>D</sub> =-250μA, V <sub>GS</sub> =0V	-30			V
I <sub>DSS</sub>	Zero Gate Voltage Drain Current	V <sub>DS</sub> =-24V, V <sub>GS</sub> =0V T <sub>J</sub> =55°C			-1 -5	μA
I <sub>GSS</sub>	Gate-Body leakage current	V <sub>DS</sub> =0V, V <sub>GS</sub> =±12V			±100	nA
V <sub>GS(th)</sub>	Gate Threshold Voltage	V <sub>DS</sub> =V <sub>GS</sub> , I <sub>D</sub> =-250μA	-0.7	-1	-1.3	V
I <sub>D(ON)</sub>	On state drain current	V <sub>GS</sub> =-4.5V, V <sub>DS</sub> =-5V	-25			A
R <sub>DS(ON)</sub>	Static Drain-Source On-Resistance	V <sub>GS</sub> =-10V, I <sub>D</sub> =-5A T <sub>J</sub> =125°C		42.5	49	mΩ
		V <sub>GS</sub> =-4.5V, I <sub>D</sub> =-4A		54	64	mΩ
		V <sub>GS</sub> =-2.5V, I <sub>D</sub> =-1A		83	120	mΩ
g <sub>FS</sub>	Forward Transconductance	V <sub>DS</sub> =-5V, I <sub>D</sub> =-5A	7	11		S
V <sub>SD</sub>	Diode Forward Voltage	I <sub>S</sub> =-1A, V <sub>GS</sub> =0V		-0.75	-1	V
I <sub>S</sub>	Maximum Body-Diode Continuous Current				-3	A
<b>DYNAMIC PARAMETERS</b>						
C <sub>iss</sub>	Input Capacitance	V <sub>GS</sub> =0V, V <sub>DS</sub> =-15V, f=1MHz		952		pF
C <sub>oss</sub>	Output Capacitance			103		pF
C <sub>rss</sub>	Reverse Transfer Capacitance			77		pF
R <sub>g</sub>	Gate resistance	V <sub>GS</sub> =0V, V <sub>DS</sub> =0V, f=1MHz		5.9		Ω
<b>SWITCHING PARAMETERS</b>						
Q <sub>g</sub>	Total Gate Charge	V <sub>GS</sub> =-4.5V, V <sub>DS</sub> =-15V, I <sub>D</sub> =-4A		9.5		nC
Q <sub>gs</sub>	Gate Source Charge			2		nC
Q <sub>gd</sub>	Gate Drain Charge			3.1		nC
t <sub>D(on)</sub>	Turn-On DelayTime	V <sub>GS</sub> =-10V, V <sub>DS</sub> =-15V, R <sub>L</sub> =3.6Ω, R <sub>GEN</sub> =6Ω		12		ns
t <sub>r</sub>	Turn-On Rise Time			4		ns
t <sub>D(off)</sub>	Turn-Off DelayTime			37		ns
t <sub>f</sub>	Turn-Off Fall Time			12		ns
t <sub>rr</sub>	Body Diode Reverse Recovery Time	I <sub>F</sub> =-5A, dI/dt=100A/μs		21		ns
Q <sub>rr</sub>	Body Diode Reverse Recovery Charge	I <sub>F</sub> =-5A, dI/dt=100A/μs		13		nC
<b>SCHOTTKY PARAMETERS</b>						
V <sub>F</sub>	Forward Voltage Drop	I <sub>F</sub> =1.0A		0.45	0.5	V
I <sub>rm</sub>	Maximum reverse leakage current	V <sub>R</sub> =30V		0.007	0.05	mA
		V <sub>R</sub> =30V, T <sub>J</sub> =125°C		3.2	10	
		V <sub>R</sub> =30V, T <sub>J</sub> =150°C		12	20	
C <sub>T</sub>	Junction Capacitance	V <sub>R</sub> =15V		37		pF

A: The value of R<sub>θJA</sub> is measured with the device mounted on 1in<sup>2</sup> FR-4 board with 2oz. Copper, in a still air environment with T<sub>A</sub>=25°C. The value in any a given application depends on the user's specific board design. The current rating is based on the t≤ 10s thermal resistance rating.

B: Repetitive rating, pulse width limited by junction temperature.

C. The R<sub>θJA</sub> is the sum of the thermal impedance from junction to lead R<sub>θJL</sub> and lead to ambient.

D. The static characteristics in Figures 1 to 6,12,14 are obtained using 80μs pulses, duty cycle 0.5% max.

E. These tests are performed with the device mounted on 1 in<sup>2</sup> FR-4 board with 2oz. Copper, in a still air environment with T<sub>A</sub>=25°C. The

TYPICAL ELECTRICAL AND THERMAL CHARACTERISTICS

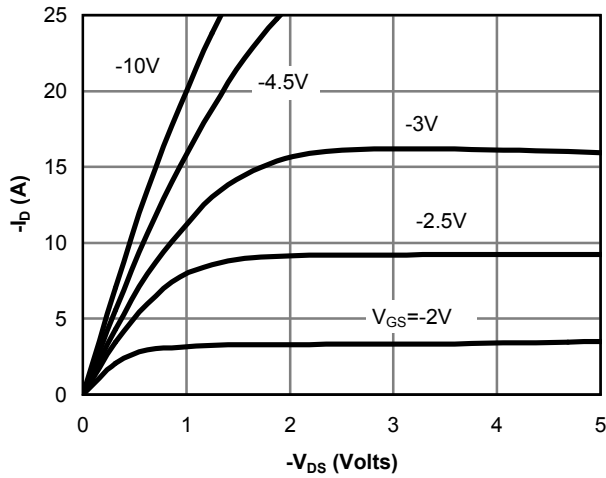

Fig 1: On-Region Characteristics

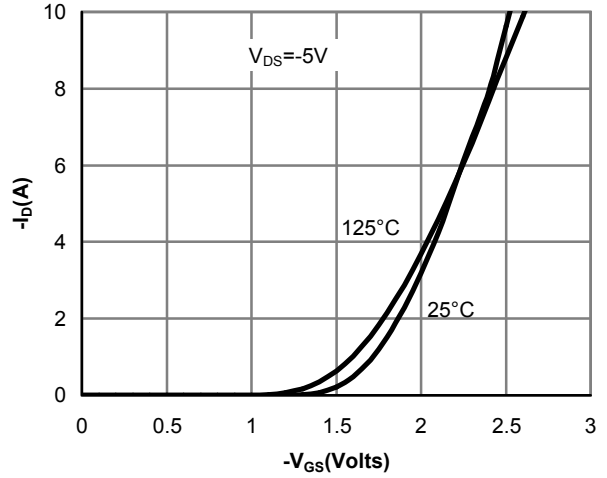

Figure 2: Transfer Characteristics

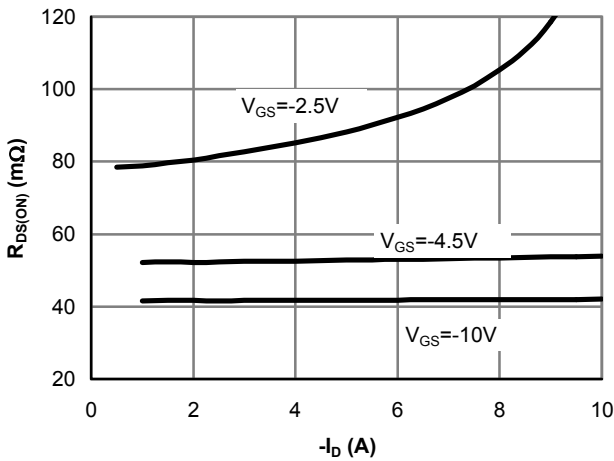

Figure 3: On-Resistance vs. Drain Current and Gate Voltage

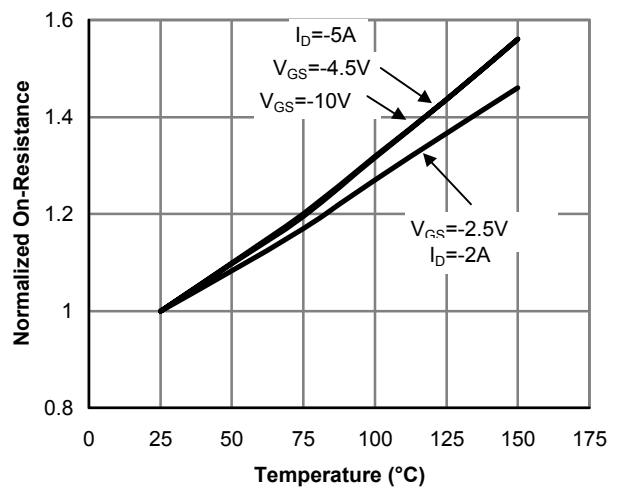

Figure 4: On-Resistance vs. Junction Temperature

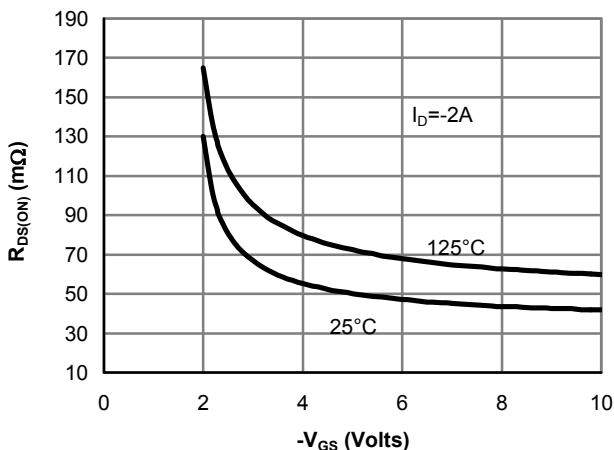

Figure 5: On-Resistance vs. Gate-Source Voltage

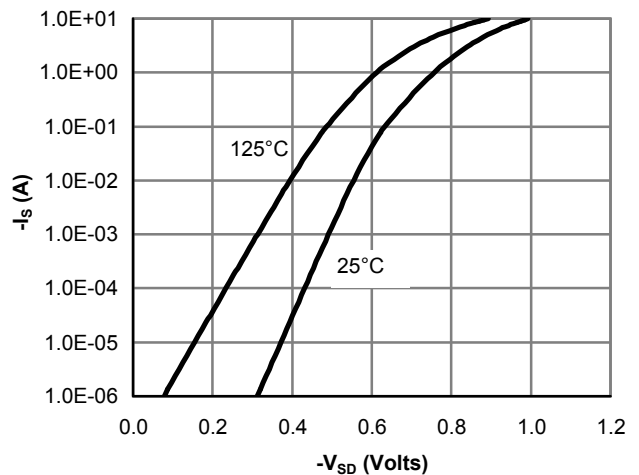

Figure 6: Body-Diode Characteristics

**AO4701**

---



i 3



50 175

perature

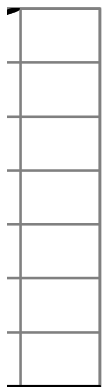

1.0 1.2

stics

TYPICAL ELECTRICAL AND THERMAL CHARACTERISTICS

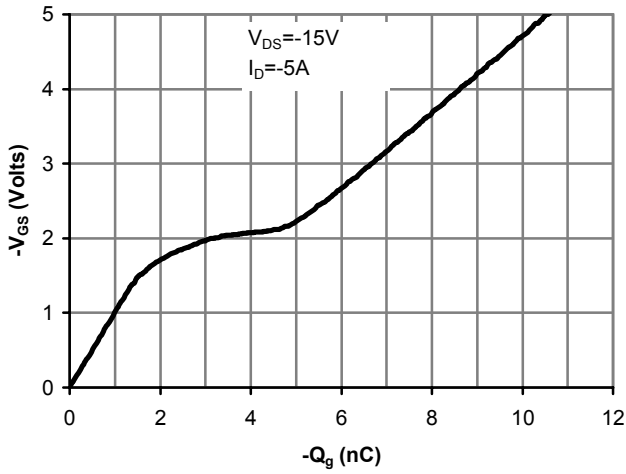

Figure 7: Gate-Charge Characteristics

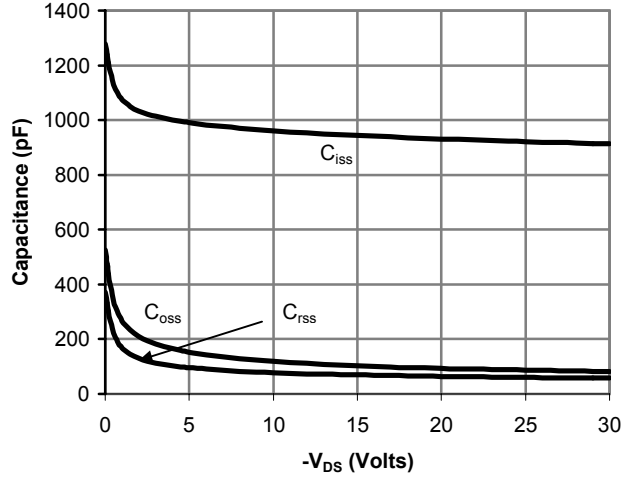

Figure 8: Capacitance Characteristics

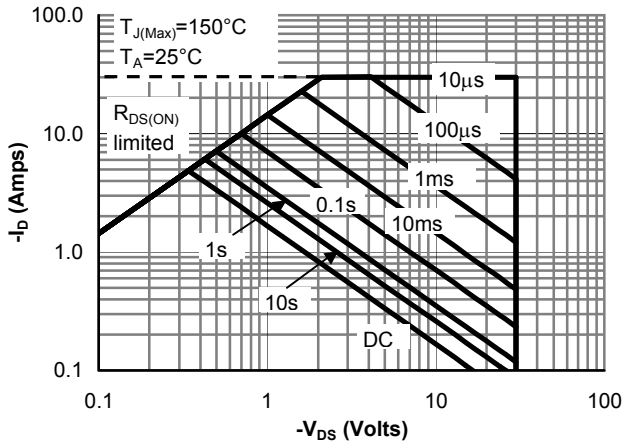

Figure 9: Maximum Forward Biased Safe Operating Area (Note E)

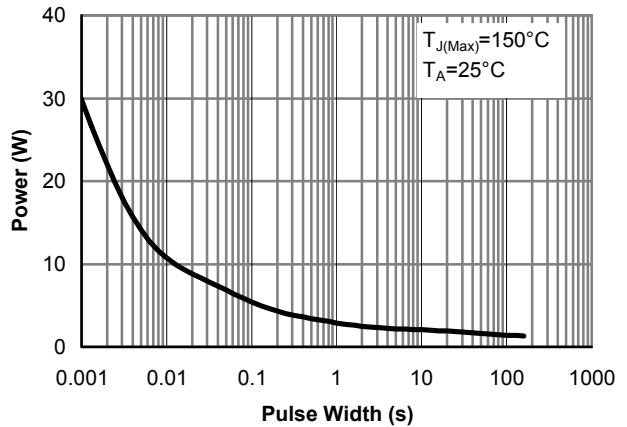

Figure 10: Single Pulse Power Rating Junction-to-Ambient (Note E)

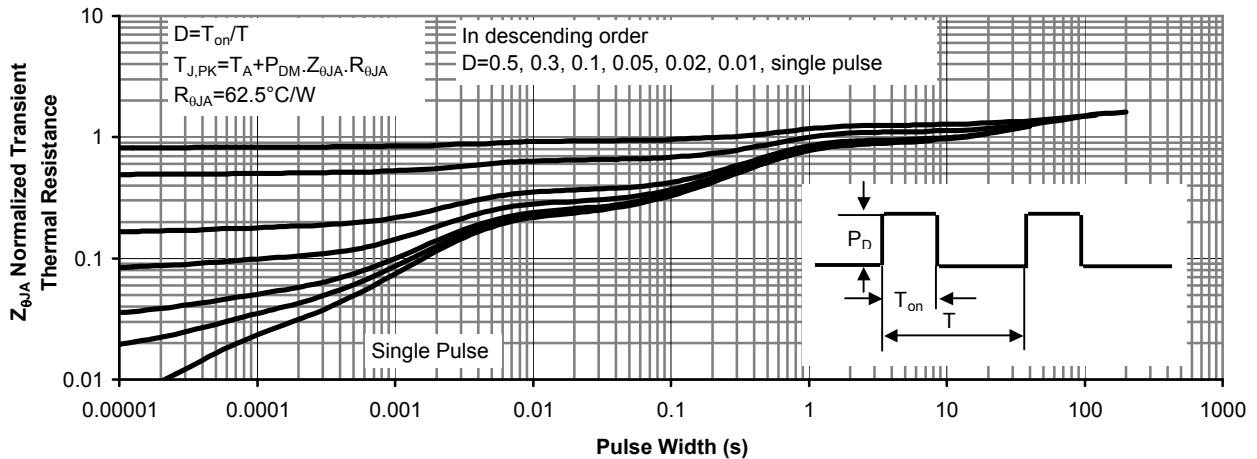

Figure 11: Normalized Maximum Transient Thermal Impedance

TYPICAL ELECTRICAL AND THERMAL CHARACTERISTICS: SCHOTTKY

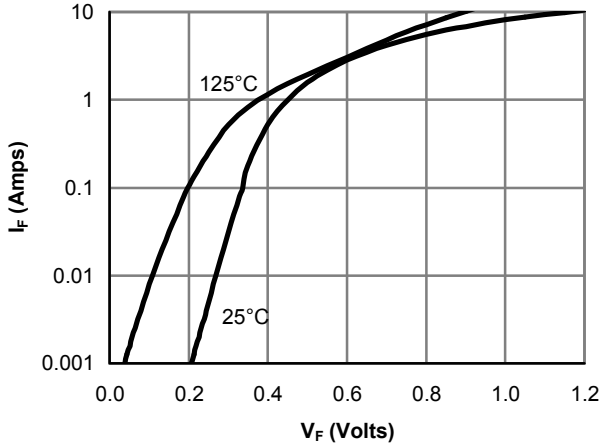

Figure 12: Schottky Forward Characteristics

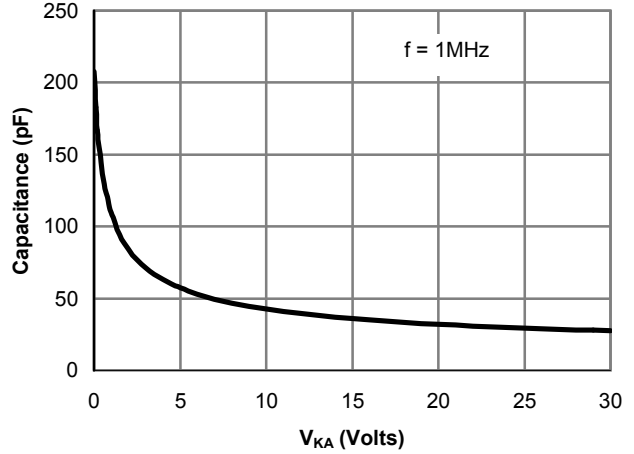

Figure 13: Schottky Capacitance Characteristics

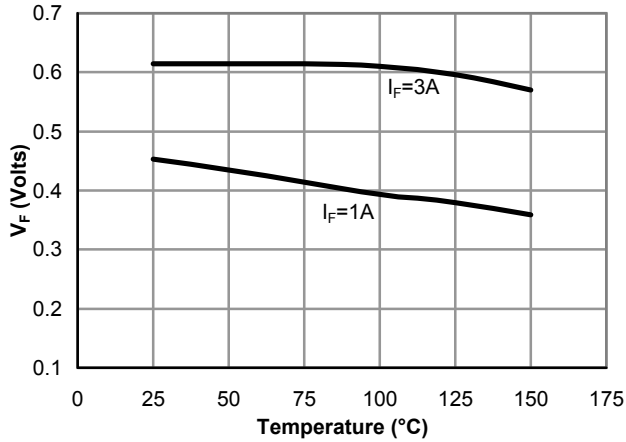

Figure 14: Schottky Forward Drop vs. Junction Temperature

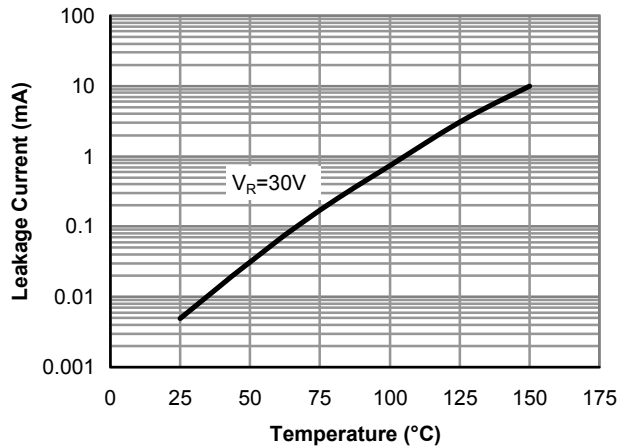

Figure 15: Schottky Leakage current vs. Junction Temperature

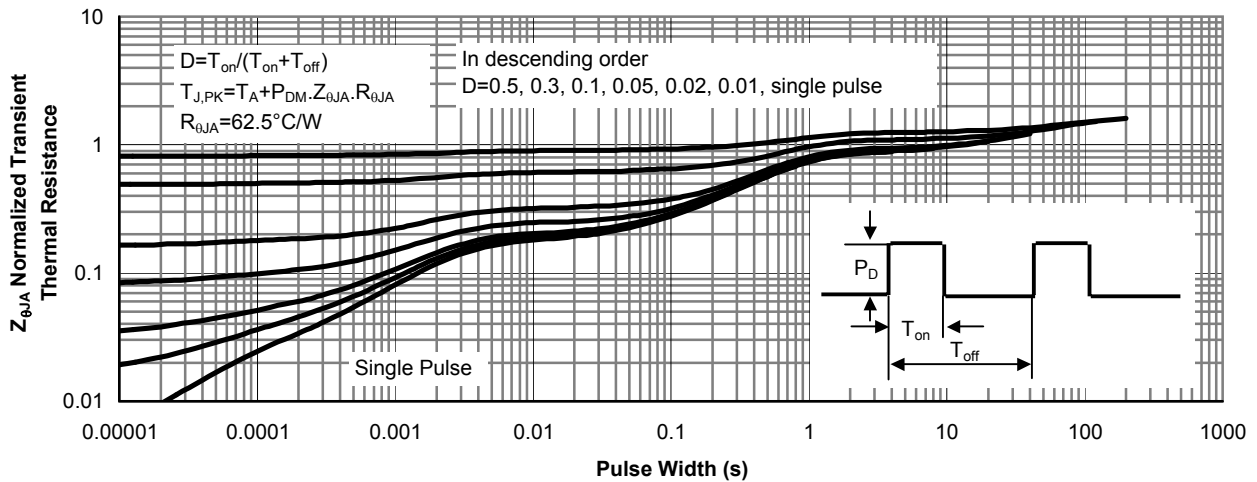
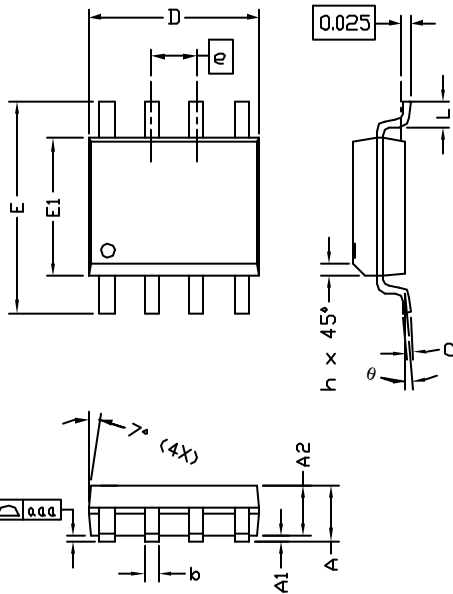

Figure 15: Schottky Normalized Maximum Transient Thermal Impedance



**ALPHA & OMEGA**  
SEMICONDUCTOR, INC.

### SO-8 Package Data



SYMBOLS	DIMENSIONS IN MILLIMETERS			DIMENSIONS IN INCHES		
	MIN	NOM	MAX	MIN	NOM	MAX
A	1.45	1.50	1.55	0.057	0.059	0.061
A1	0.00	---	0.10	0.000	---	0.004
A2	---	1.45	---	---	0.057	---
b	0.33	---	0.51	0.013	---	0.020
c	0.19	---	0.25	0.007	---	0.010
D	4.80	---	5.00	0.189	---	0.197
E1	3.80	---	4.00	0.150	---	0.157
e	1.27 BSC			0.050 BSC		
E	5.80	---	6.20	0.228	---	0.244
h	0.25	---	0.50	0.010	---	0.020
L	0.40	---	1.27	0.016	---	0.050
aaa	---	---	0.10	---	---	0.004
θ	0°	---	8°	0°	---	8°

- NOTE:
- LEAD FINISH: 150 MICRONS (3.8 um) MIN. THICKNESS OF Tin/Lead (SOLDER) PLATED ON LEAD
  - TOLERANCE ±0.10 mm (4 mil) UNLESS OTHERWISE SPECIFIED
  - COPLANARITY : 0.10 mm
  - DIMENSION L IS MEASURED IN GAGE PLANE

#### PACKAGE MARKING DESCRIPTION

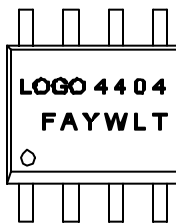

- NOTE:
- LOGO - AOS LOGO
  - 4701 - PART NUMBER CODE.
  - F - FAB LOCATION
  - A - ASSEMBLY LOCATION
  - Y - YEAR CODE
  - W - WEEK CODE.
  - L N - ASSEMBLY LOT CODE

#### SO-8 PART NO. CODE

PART NO.	CODE
AO4701	4701

#### RECOMMENDED LAND PATTERN

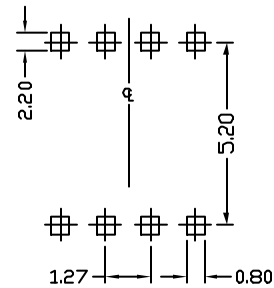

UNIT: mm



**ALPHA & OMEGA**  
SEMICONDUCTOR, INC.

## SO-8 Tape and Reel Data

### SO-8 Carrier Tape

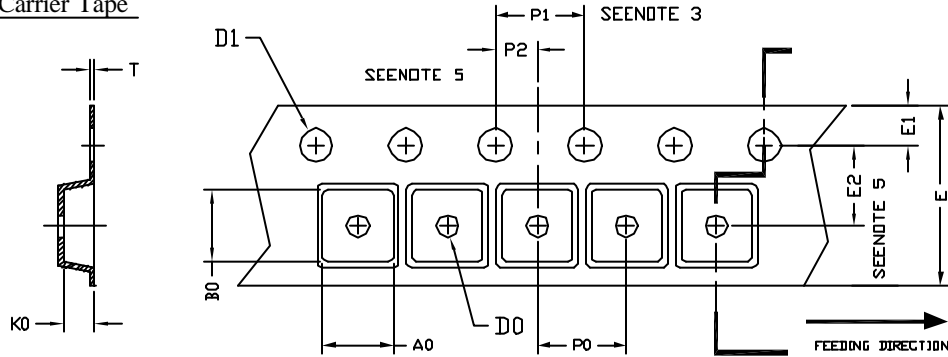

UNIT: MM

PACKAGE	A0	B0	K0	D0	D1	E	E1	E2	P0	P1	P2	T
SO-8 (12 nm)	6.40 ±0.10	5.20 ±0.10	2.10 ±0.10	1.60 ±0.10	1.30 ±0.10	12.00 ±0.30	1.75 ±0.10	5.50 ±0.05	8.00 ±0.10	4.00 ±0.10	2.00 ±0.05	0.25 ±0.05

### SO-8 Reel

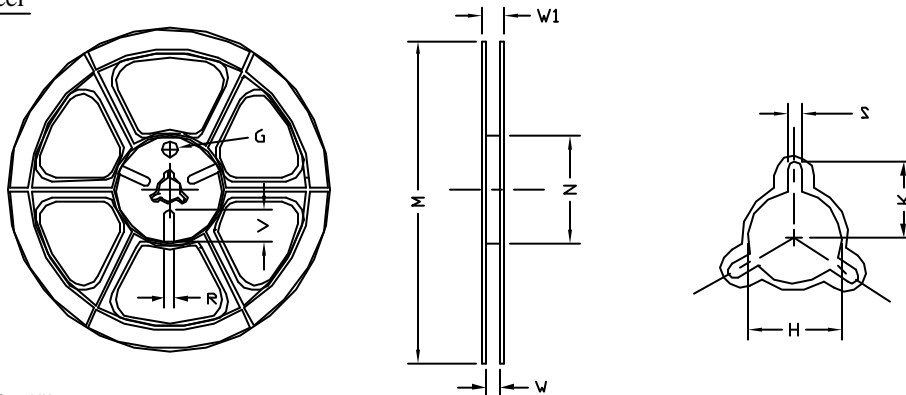

UNIT: MM

TAPE SIZE	REEL SIZE	M	N	W	W1	H	K	S	G	R	V
12 mm	ø330	ø330.00 ±0.50	ø97.00 ±0.10	13.00 ±0.30	17.40 ±1.00	ø13.00 +0.50 -0.20	10.60	2.00 ±0.50	---	---	---

### SO-8 Tape

Leader / Trailer  
& Orientation

