



**ALPHA & OMEGA**  
SEMICONDUCTOR, INC.

Aug 2002

**AO6405**

**P-Channel Enhancement Mode Field Effect Transistor**

**General Description**

The AO6405 uses advanced trench technology to provide excellent  $R_{DS(ON)}$  with low gate charge. This device is suitable for use as a load switch or in PWM applications.

**Features**

- $V_{DS} (V) = -30V$
- $I_D = -5 A$
- $R_{DS(ON)} < 52m\Omega (V_{GS} = -10V)$
- $R_{DS(ON)} < 87m\Omega (V_{GS} = -4.5V)$

**TSOP6  
Top View**

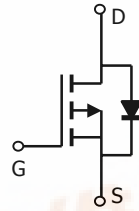
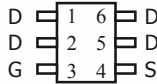

**Absolute Maximum Ratings  $T_A=25^\circ C$  unless otherwise noted**

Parameter	Symbol	Maximum	Units
Drain-Source Voltage	$V_{DS}$	-30	V
Gate-Source Voltage	$V_{GS}$	$\pm 20$	V
Continuous Drain Current <sup>A</sup>	$I_D$	$T_A=25^\circ C$	-5
		$T_A=70^\circ C$	-4.2
Pulsed Drain Current <sup>B</sup>	$I_{DM}$	-20	A
Power Dissipation <sup>A</sup>	$P_D$	$T_A=25^\circ C$	2
		$T_A=70^\circ C$	1.4
Junction and Storage Temperature Range	$T_J, T_{STG}$	-55 to 150	$^\circ C$

**Thermal Characteristics**

Parameter	Symbol	Typ	Max	Units
Maximum Junction-to-Ambient <sup>A</sup>	$R_{\theta JA}$	47.5	62.5	$^\circ C/W$
Maximum Junction-to-Ambient <sup>A</sup>		Steady-State	74	110
Maximum Junction-to-Lead <sup>C</sup>	$R_{\theta JL}$	37	50	$^\circ C/W$



Electrical Characteristics (T<sub>J</sub>=25°C unless otherwise noted)

Symbol	Parameter	Conditions	Min	Typ	Max	Units
<b>STATIC PARAMETERS</b>						
BV <sub>DSS</sub>	Drain-Source Breakdown Voltage	I <sub>D</sub> =-250μA, V <sub>GS</sub> =0V	-30			V
I <sub>DSS</sub>	Zero Gate Voltage Drain Current	V <sub>DS</sub> =-24V, V <sub>GS</sub> =0V T <sub>J</sub> =55°C			-1 -5	μA
I <sub>GSS</sub>	Gate-Body leakage current	V <sub>DS</sub> =0V, V <sub>GS</sub> =±20V			±100	nA
V <sub>GS(th)</sub>	Gate Threshold Voltage	V <sub>DS</sub> =V <sub>GS</sub> , I <sub>D</sub> =-250μA	-1	-1.8	-3	V
I <sub>D(ON)</sub>	On state drain current	V <sub>GS</sub> =-4.5V, V <sub>DS</sub> =-5V	-10			A
R <sub>DS(ON)</sub>	Static Drain-Source On-Resistance	V <sub>GS</sub> =-10V, I <sub>D</sub> =5.0A T <sub>J</sub> =125°C		39 54	52 70	mΩ
		V <sub>GS</sub> =-4.5V, I <sub>D</sub> =-4A		67	87	mΩ
g <sub>FS</sub>	Forward Transconductance	V <sub>DS</sub> =-5V, I <sub>D</sub> =-5A	6	8.6		S
V <sub>SD</sub>	Diode Forward Voltage	I <sub>S</sub> =-1A, V <sub>GS</sub> =0V		-0.77	-1	V
I <sub>S</sub>	Maximum Body-Diode Continuous Current				-2.8	A
<b>DYNAMIC PARAMETERS</b>						
C <sub>iss</sub>	Input Capacitance	V <sub>GS</sub> =0V, V <sub>DS</sub> =-15V, f=1MHz		700		pF
C <sub>oss</sub>	Output Capacitance			120		pF
C <sub>rss</sub>	Reverse Transfer Capacitance			75		pF
R <sub>g</sub>	Gate resistance	V <sub>GS</sub> =0V, V <sub>DS</sub> =0V, f=1MHz		10		Ω
<b>SWITCHING PARAMETERS</b>						
Q <sub>g</sub> (10V)	Total Gate Charge (10V)	V <sub>GS</sub> =-10V, V <sub>DS</sub> =-15V, I <sub>D</sub> =-5A		14.7		nC
Q <sub>g</sub> (4.5V)	Total Gate Charge (4.5V)			7.6		nC
Q <sub>gs</sub>	Gate Source Charge			2		nC
Q <sub>gd</sub>	Gate Drain Charge			3.8		nC
t <sub>D(on)</sub>	Turn-On DelayTime			8.3		ns
t <sub>r</sub>	Turn-On Rise Time	V <sub>GS</sub> =-10V, V <sub>DS</sub> =-15V, R <sub>L</sub> =3Ω, R <sub>GEN</sub> =3Ω		5		ns
t <sub>D(off)</sub>	Turn-Off DelayTime			29		ns
t <sub>f</sub>	Turn-Off Fall Time			14		ns
t <sub>rr</sub>	Body Diode Reverse Recovery Time	I <sub>F</sub> =-5A, dI/dt=100A/μs		23.5		ns
Q <sub>rr</sub>	Body Diode Reverse Recovery Charge	I <sub>F</sub> =-5A, dI/dt=100A/μs		13.4		nC

A: The value of R<sub>θJA</sub> is measured with the device mounted on 1in<sup>2</sup> FR-4 board with 2oz. Copper, in a still air environment with T<sub>A</sub>=25°C. The value in any a given application depends on the user's specific board design. The current rating is based on the t<sub>s</sub> ≤ 10s thermal resistance rating.

B: Repetitive rating, pulse width limited by junction temperature.

C: The R<sub>θJA</sub> is the sum of the thermal impedance from junction to lead R<sub>θJL</sub> and lead to ambient.

D: The static characteristics in Figures 1 to 6,12,14 are obtained using 80μs pulses, duty cycle 0.5% max.

E: These tests are performed with the device mounted on 1 in<sup>2</sup> FR-4 board with 2oz. Copper, in a still air environment with T<sub>A</sub>=25°C. The SOA curve provides a single pulse rating.

TYPICAL ELECTRICAL AND THERMAL CHARACTERISTICS

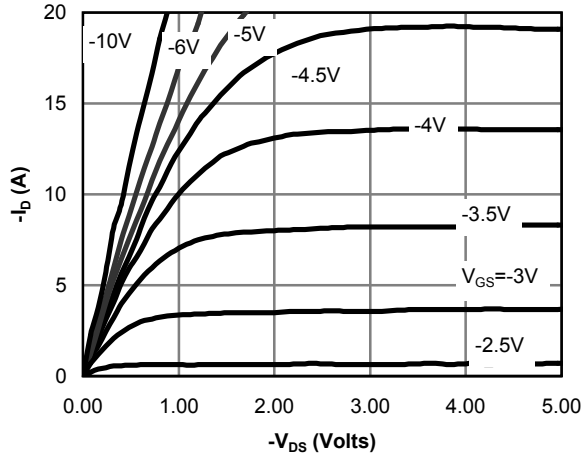

Figure 1: On-Region Characteristics

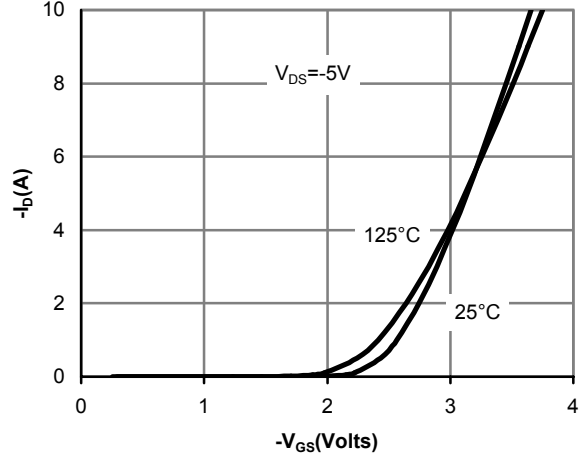

Figure 2: Transfer Characteristics

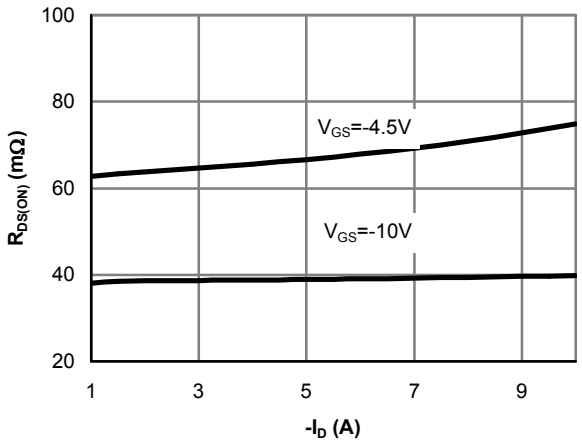

Figure 3: On-Resistance vs. Drain Current and Gate Voltage

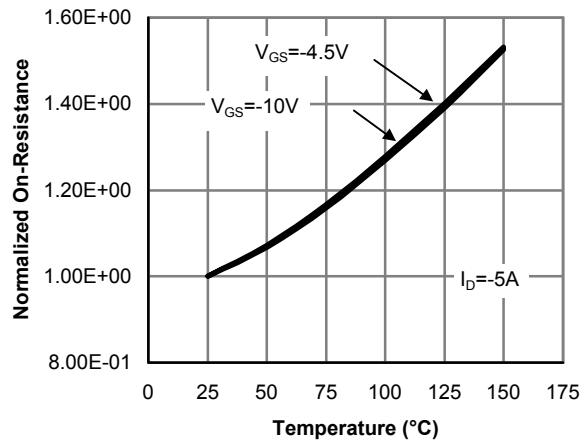

Figure 4: On-Resistance vs. Junction Temperature

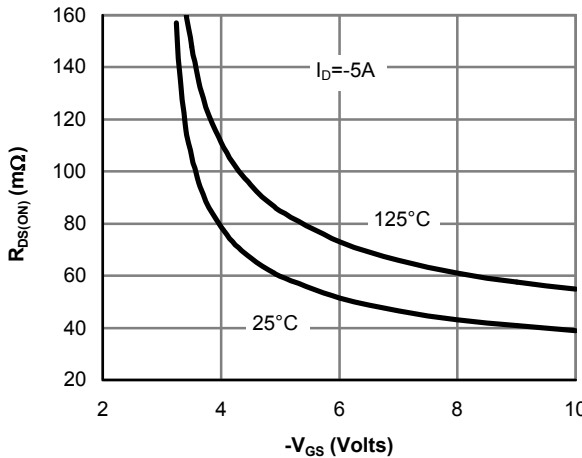

Figure 5: On-Resistance vs. Gate-Source Voltage

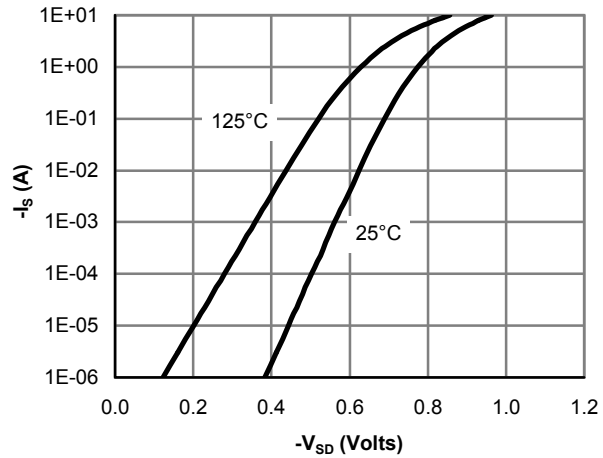

Figure 6: Body-Diode Characteristics

TYPICAL ELECTRICAL AND THERMAL CHARACTERISTICS

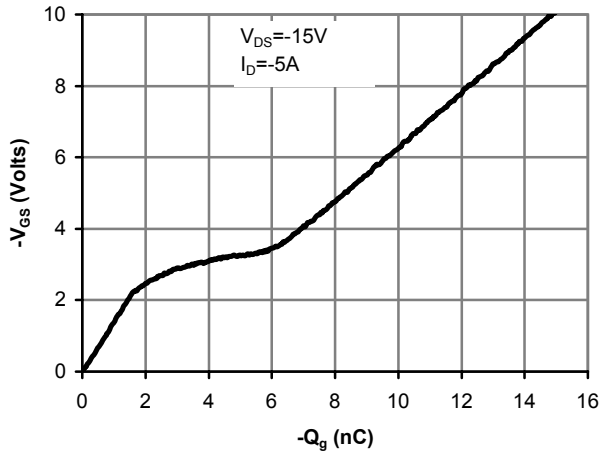

Figure 7: Gate-Charge Characteristics

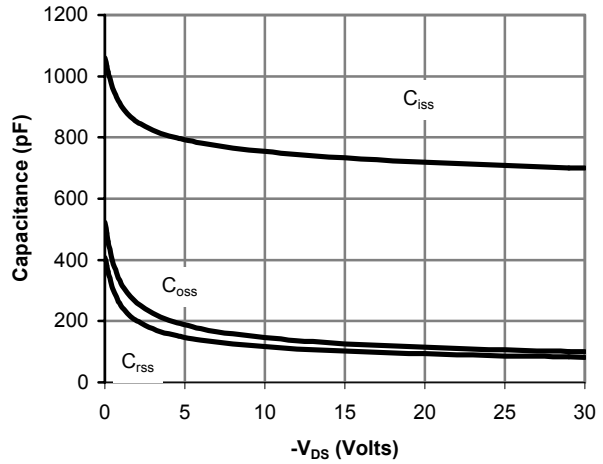

Figure 8: Capacitance Characteristics

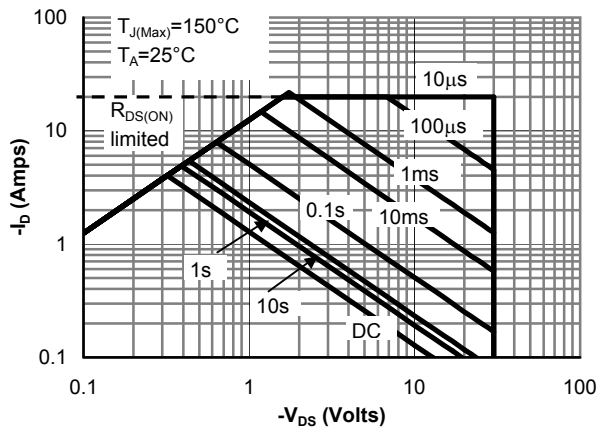

Figure 9: Maximum Forward Biased Safe Operating Area (Note E)

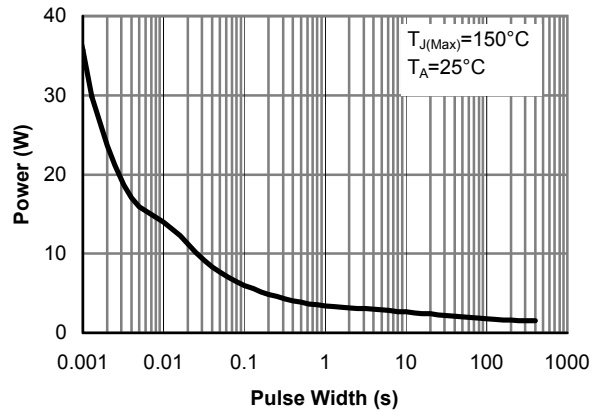

Figure 10: Single Pulse Power Rating Junction-to-Ambient (Note E)

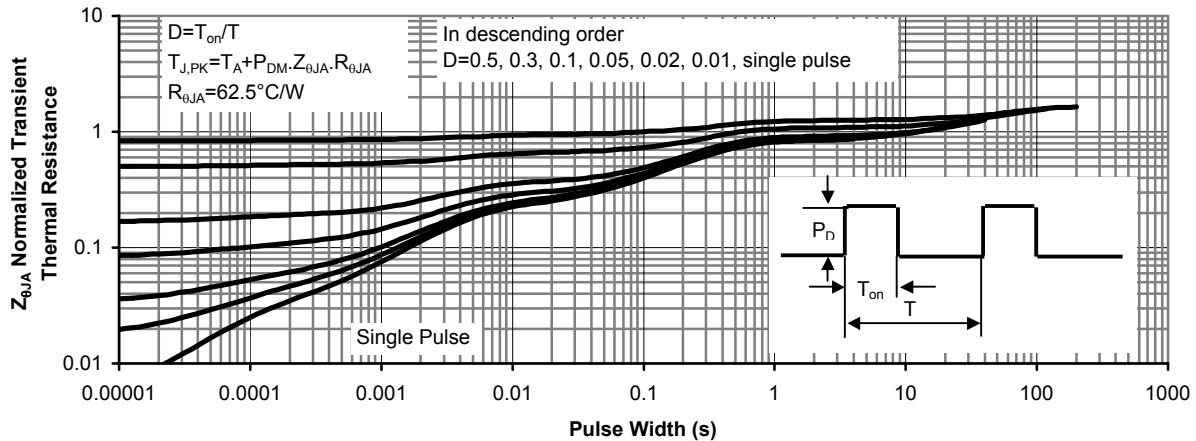
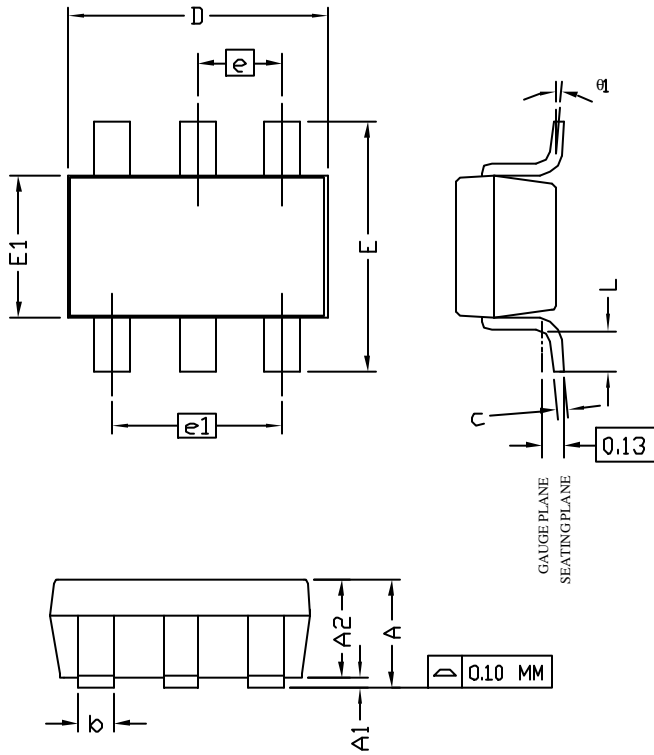

Figure 11: Normalized Maximum Transient Thermal Impedance



**ALPHA & OMEGA**  
SEMICONDUCTOR, INC.

## TSOP-6 Package Data



SYMBOLS	DIMENSIONS IN MILLIMETERS		
	MIN	NOM	MAX
A	1.00	—	1.25
A1	0.00	—	0.10
A2	1.00	1.10	1.15
b	0.35	0.40	0.50
c	0.10	0.13	0.20
D	2.70	2.90	3.10
E	2.60	2.80	3.00
E1	1.60	1.80	2.00
e	0.95 BSC		
e1	1.90 BSC		
L	0.37	—	—
$\theta 1$	1°	5°	8°

- NOTE:
- LEAD FINISH: 150 MICRONS (3.8  $\mu$ m) MIN. THICKNESS OF Tin/Lead (SOLDER) PLATED ON LEAD
  - TOLERANCE  $\pm 0.100$  mm (4 mil) UNLESS OTHERWISE SPECIFIED
  - COPLANARITY : 0.1000 mm
  - DIMENSION L IS MEASURED IN GAGE PLANE

### PACKAGE MARKING DESCRIPTION

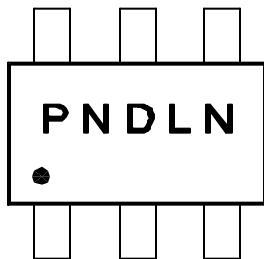

### TSOP-6 PART NO. CODE

PART NO.	CODE
AO6405	D5

- NOTE:
- P N - PART NUMBER CODE.
  - D - YEAR AND WEEK CODE.
  - L N - ASSEMBLY LOT CODE, FAB AND ASSEMBLY LOCATION CODE.

### RECOMMENDED LAND PATTERN

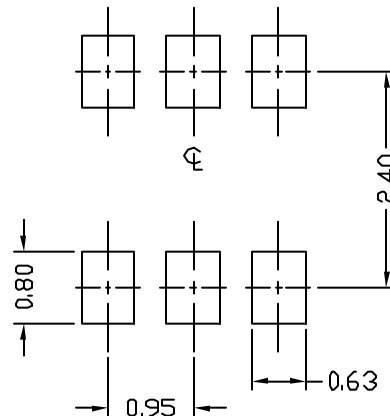



**ALPHA & OMEGA**  
SEMICONDUCTOR, INC.

## TSOP-6 Tape and Reel Data

### TSOP-6 Carrier Tape

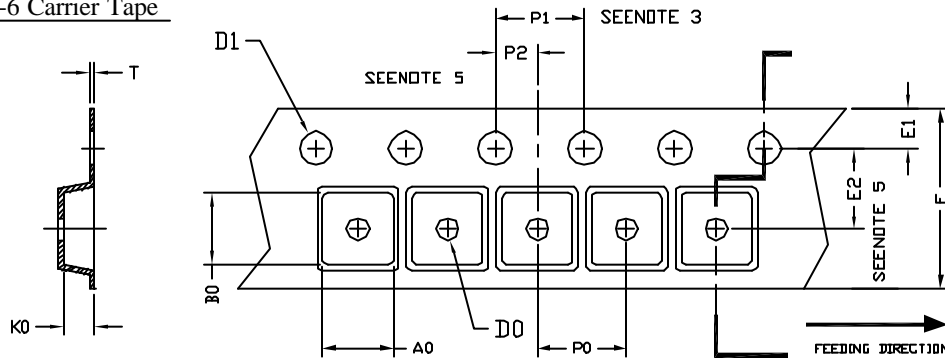

UNIT: MM

PACKAGE	A0	B0	K0	D0	D1	E	E1	E2	P0	P1	P2	T
SDT-23 (B mm)	3.15 ±0.10	3.27 ±0.10	1.34 ±0.10	1.10 ±0.01	1.30 ±0.10	8.00 ±0.20	1.73 ±0.10	3.50 ±0.05	4.00 ±0.10	4.00 ±0.10	2.00 ±0.10	0.25 ±0.05

### TSOP-6 Reel

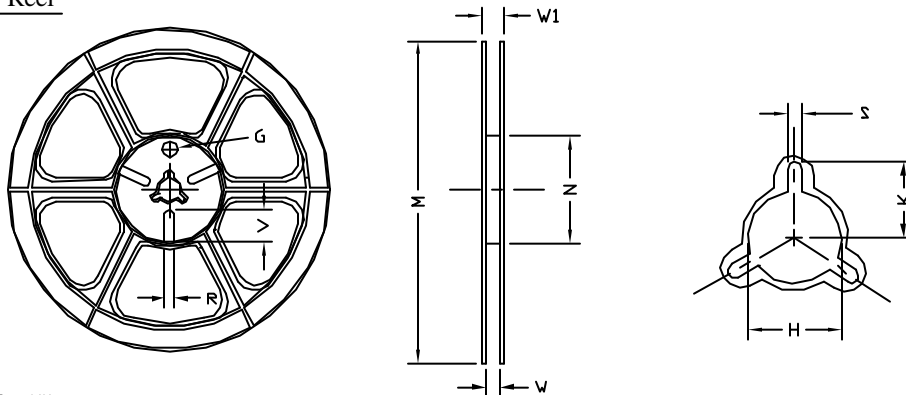

UNIT: MM

TAPE SIZE	REEL SIZE	M	N	W	W1	H	K	S	G	R	V
8 mm	∅180	∅180.00 ±0.50	∅60.50	9.00 ±0.30	11.40 ±1.00	∅13.00 +0.50 -0.20	10.60	2.00 ±0.50	∅9.00	5.00	18.00

### TSOP-6 Tape

Leader / Trailer  
& Orientation

