

# APM9930/C



Dual Enhancement Mode MOSFET (N-and P-Channel)

## Features

- N-Channel  
20V/15A,  $R_{DS(ON)}=12m\Omega(\text{typ.}) @ V_{GS}=10V$   
 $R_{DS(ON)}=17m\Omega(\text{typ.}) @ V_{GS}=4.5V$   
 $R_{DS(ON)}=25m\Omega(\text{typ.}) @ V_{GS}=2.5V$
- P-Channel  
-20V/-5A,  $R_{DS(ON)}=60m\Omega(\text{typ.}) @ V_{GS}=-10V$   
 $R_{DS(ON)}=72m\Omega(\text{typ.}) @ V_{GS}=-4.5V$   
 $R_{DS(ON)}=98m\Omega(\text{typ.}) @ V_{GS}=-2.5V$
- Super High Dense Cell Design for Extremely Low  $R_{DS(ON)}$
- Reliable and Rugged
- SO-8 Package

## Pin Description

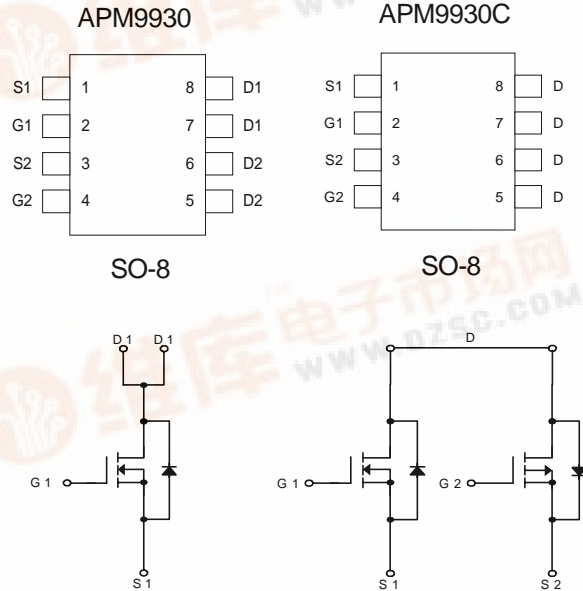

N-Channel MOSFET

N- and P-Channel MOSFET

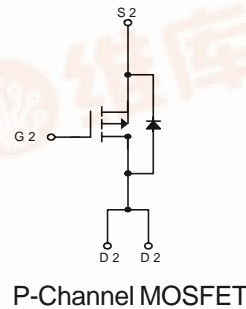

P-Channel MOSFET

## Applications

- Power Management in Notebook Computer , Portable Equipment and Battery Powered Systems.

## Ordering and Marking Information

<p>APM9930/C □□-□□</p> <p>Handling Code</p> <p>Temp. Range</p> <p>Package Code</p>	<p>Package Code K : SO-8</p> <p>Operation Junction Temp. Range C : -55 to 150°C</p> <p>Handling Code TR : Tape &amp; Reel</p>
<p>APM9930/C K : <span style="border: 1px solid black; padding: 2px;">APM9930/C XXXXX</span></p>	<p>XXXXX - Date Code</p>

ANPEC reserves the right to make changes to improve reliability or manufacturability without notice, and advise customers to obtain the latest version of relevant information to verify before placing orders.

## Absolute Maximum Ratings ( $T_A = 25^\circ\text{C}$ unless otherwise noted)

Symbol	Parameter	N-Channel	P-Channel	Unit	
$V_{DSS}$	Drain-Source Voltage	20	-20	V	
$V_{GSS}$	Gate-Source Voltage	$\pm 12$	$\pm 12$		
$I_D^*$	Maximum Drain Current – Continuous	15	-5	A	
$I_{DM}$	Maximum Drain Current – Pulsed	30	-10		
$P_D$	Maximum Power Dissipation	$T_A=25^\circ\text{C}$	2.5	2.5	W
		$T_A=100^\circ\text{C}$	1.0	1.0	
$T_J$	Maximum Junction Temperature	150		$^\circ\text{C}$	
$T_{STG}$	Storage Temperature Range	-55 to 150		$^\circ\text{C}$	
$R_{\theta JA}$	Thermal Resistance – Junction to Ambient	50		$^\circ\text{C/W}$	

\* Surface Mounted on FR4 Board,  $t \leq 10$  sec.

## Electrical Characteristics ( $T_A = 25^\circ\text{C}$ unless otherwise noted)

Symbol	Parameter	Test Condition	APM9930/C			Unit	
			Min.	Typ.	Max.		
<b>Static</b>							
$BV_{DSS}$	Drain-Source Breakdown Voltage	$V_{GS}=0V, I_{DS}=250\mu A$	N-Ch	20		V	
			P-Ch	-20			
$I_{DSS}$	Zero Gate Voltage Drain Current	$V_{DS}=18V, V_{GS}=0V$	N-Ch		1	$\mu A$	
		$V_{DS}=-18V, V_{GS}=0V$	P-Ch		-1		
$V_{GS(th)}$	Gate Threshold Voltage	$V_{DS}=V_{GS}, I_{DS}=250\mu A$	N-Ch	0.6	1.3	V	
		$V_{DS}=V_{GS}, I_{DS}=-250\mu A$	P-Ch	-0.6	-1.3		
$I_{GSS}$	Gate Leakage Current	$V_{GS}=\pm 12V, V_{DS}=0V$	N-Ch		$\pm 100$	nA	
		$V_{GS}=\pm 10V, V_{DS}=0V$	P-Ch		$\pm 100$		
$R_{DS(ON)}^a$	Drain-Source On-state Resistance	$V_{GS}=10V, I_{DS}=15A$	N-Ch		12	15	m $\Omega$
		$V_{GS}=4.5V, I_{DS}=5A$			17	20	
		$V_{GS}=2.5V, I_{DS}=2A$			25	30	
		$V_{GS}=-10V, I_{DS}=-5A$	P-Ch		60	70	
		$V_{GS}=-4.5V, I_{DS}=-3.2A$			72	80	
		$V_{GS}=-2.5V, I_{DS}=-1A$			98	105	

### Notes

<sup>a</sup> : Pulse test ; pulse width  $\leq 300\mu s$ , duty cycle  $\leq 2\%$

**Electrical Characteristics (Cont.)** ( $T_A = 25^\circ\text{C}$  unless otherwise noted)

Symbol	Parameter	Test Condition	APM9930/C			Unit	
			Min.	Typ.	Max.		
$V_{SD}^a$	Diode Forward Voltage	$I_{SD}=5A, V_{GS}=0V$	N-Ch	0.6		1.3	V
		$I_{SD}=-2A, V_{GS}=0V$	P-Ch	-0.6		-1.3	
<b>Dynamic<sup>a</sup></b>							
$Q_g$	Total Gate Charge	N-Channel $V_{DS}=10V, I_{DS}=6A$	N-Ch		14	22	nC
			P-Ch		6.8	16	
$Q_{gs}$	Gate-Source Charge	$V_{GS}=4.5V$ P-Channel	N-Ch		5		
			P-Ch		3.6		
$Q_{gd}$	Gate-Drain Charge	$V_{DS}=-10V, I_{DS}=-1A$ $V_{GS}=-4.5V$	N-Ch		2.8		
			P-Ch		1.08		
$t_{d(ON)}$	Turn-on Delay Time	N-Channel $V_{DD}=10V, I_{DS}=1A,$ $V_{GEN}=4.5V, R_G=10\Omega$	N-Ch		6	12	ns
			P-Ch		21	42	
$T_r$	Turn-on Rise Time	P-Channel $V_{DD}=-10V, I_{DS}=-1A,$ $V_{GEN}=-4.5V, R_G=10\Omega$	N-Ch		5	10	
			P-Ch		45	85	
$t_{d(OFF)}$	Turn-off Delay Time	N-Channel $V_{DD}=10V, I_{DS}=1A,$ $V_{GEN}=4.5V, R_G=10\Omega$	N-Ch		16	40	
			P-Ch		36	80	
$T_f$	Turn-off Fall Time	P-Channel $V_{DD}=-10V, I_{DS}=-1A,$ $V_{GEN}=-4.5V, R_G=10\Omega$	N-Ch		5	20	
			P-Ch		20	40	
$C_{iss}$	Input Capacitance	$V_{GS}=0V$	N-Ch		1225		pF
			P-Ch		495		
$C_{oss}$	Output Capacitance	$V_{DS}=15V$ Frequency=1.0MHz	N-Ch		330		
			P-Ch		130		
$C_{rss}$	Reverse Transfer Capacitance		N-Ch		220		
			P-Ch		60		

## Notes

<sup>a</sup> : Guaranteed by design, not subject to production testing

# Typical Characteristics

N-Channel

Output Characteristics

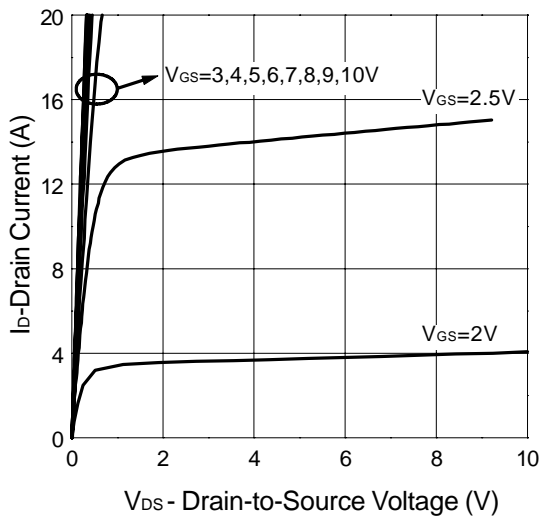

Transfer Characteristics

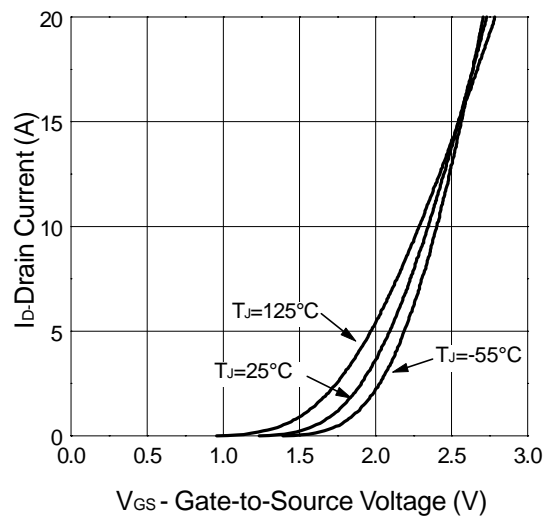

Threshold Voltage vs. Junction Temperature

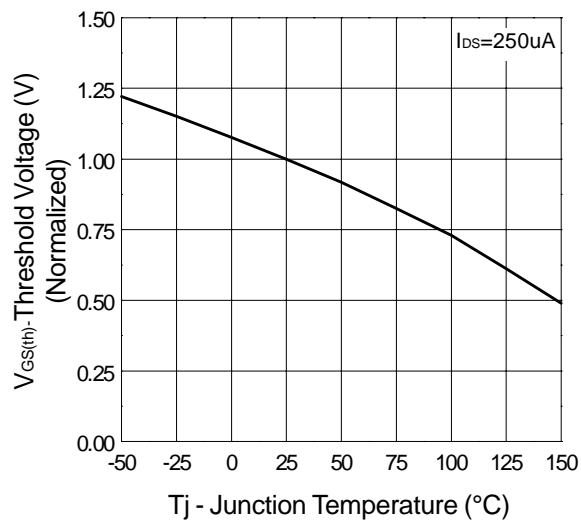

On-Resistance vs. Drain Current

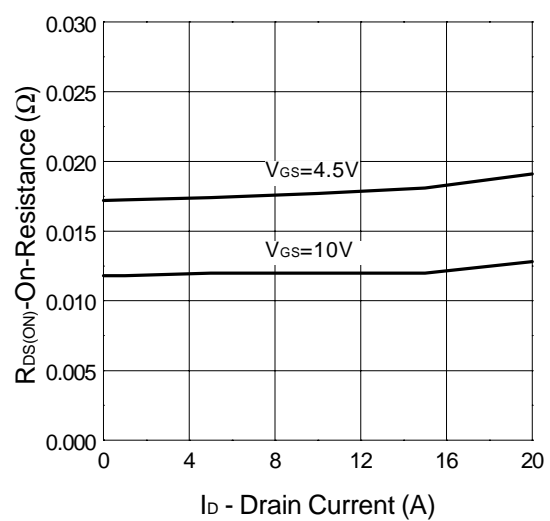

## Typical Characteristics (Cont.)

N-Channel

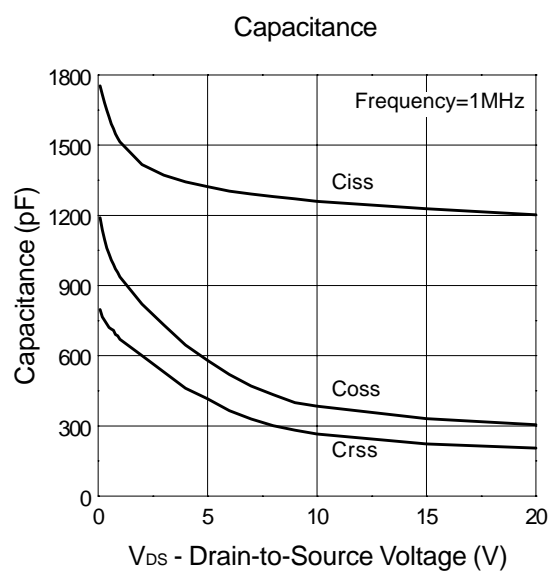
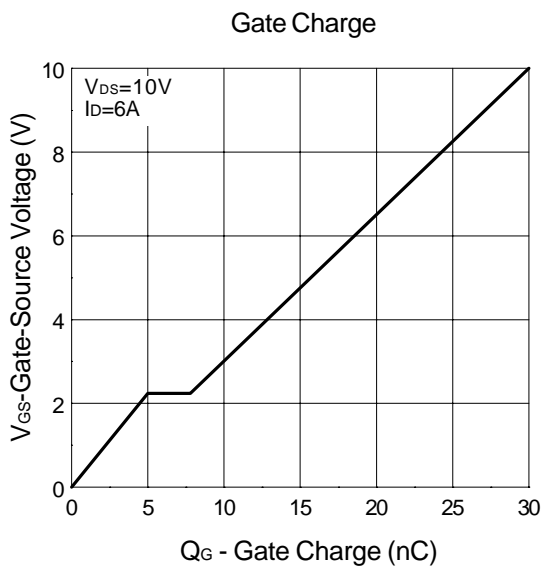
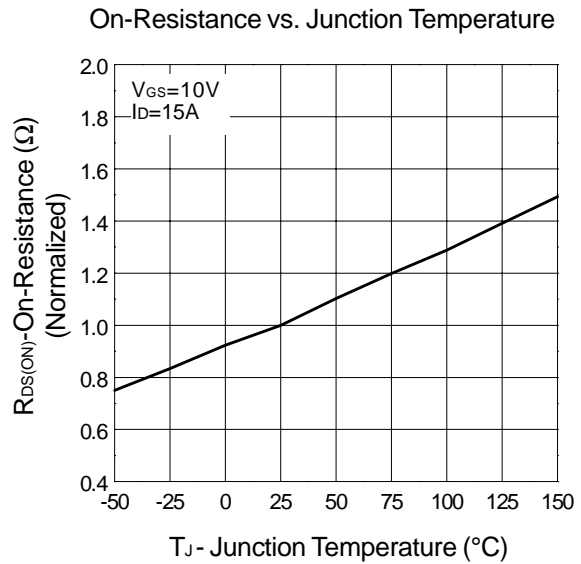
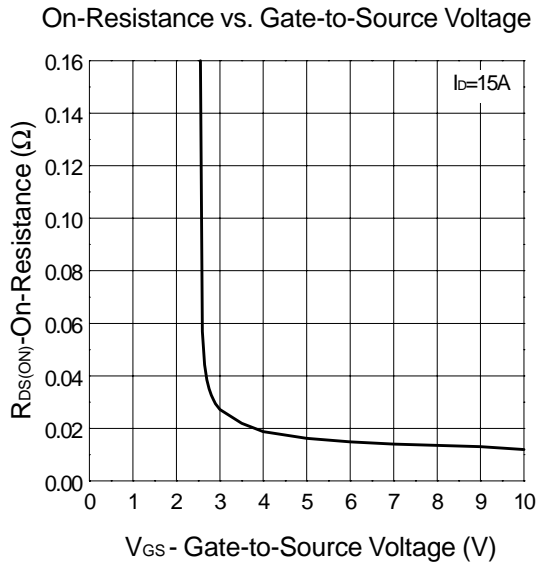

## Typical Characteristics (Cont.)

N-Channel

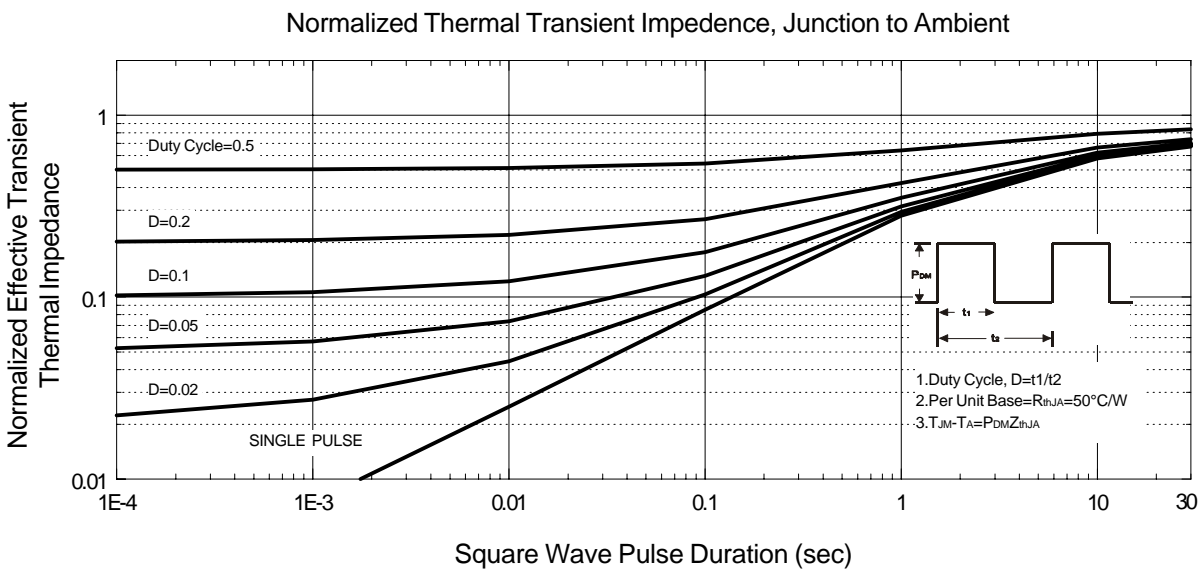
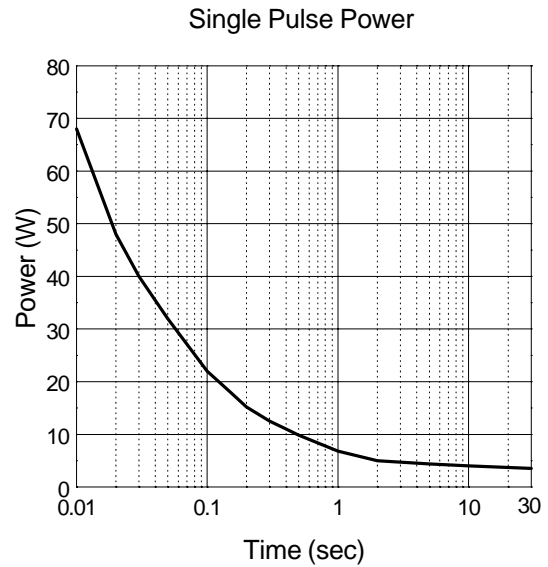
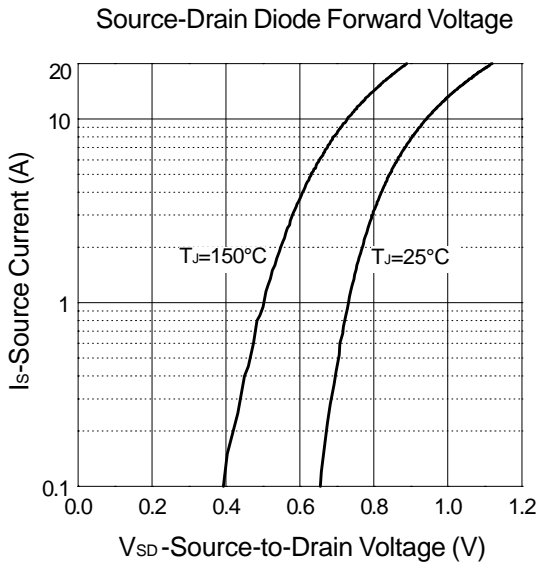

# Typical Characteristics

P-Channel

Output Characteristics

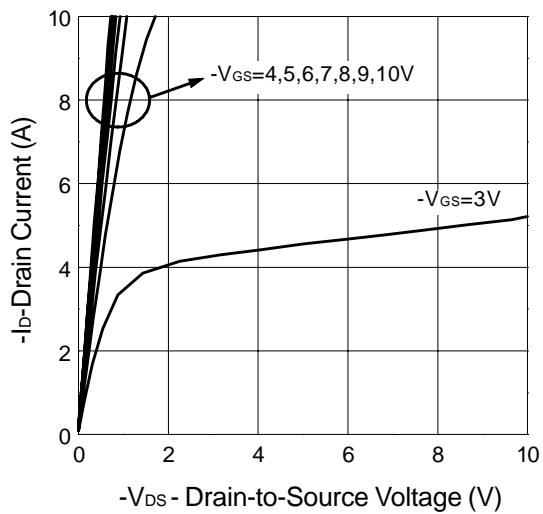

Transfer Characteristics

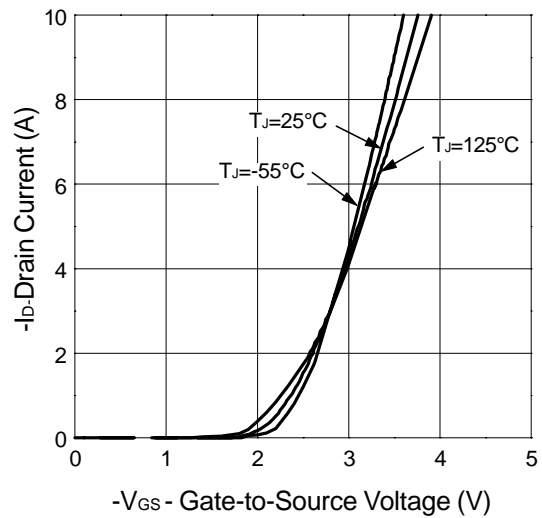

Threshold Voltage vs. Junction Temperature

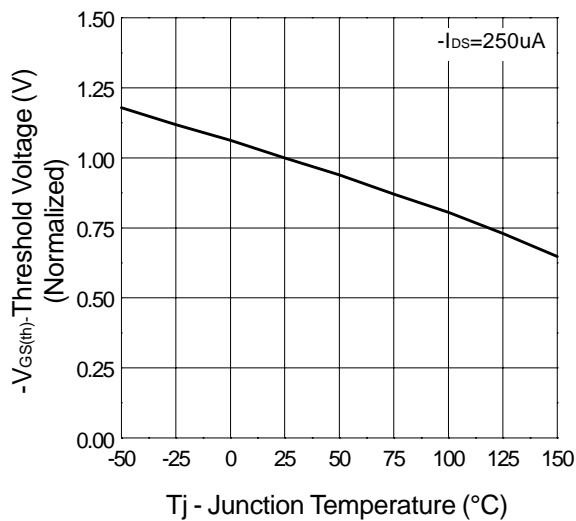

On-Resistance vs. Drain Current

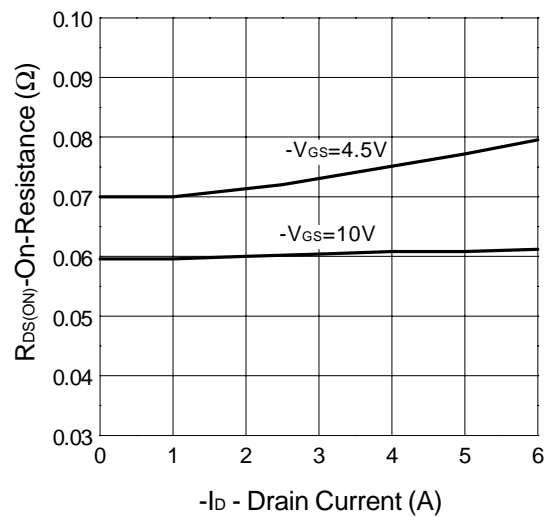

## Typical Characteristics (Cont.)

P-Channel

On-Resistance vs. Gate-to-Source Voltage

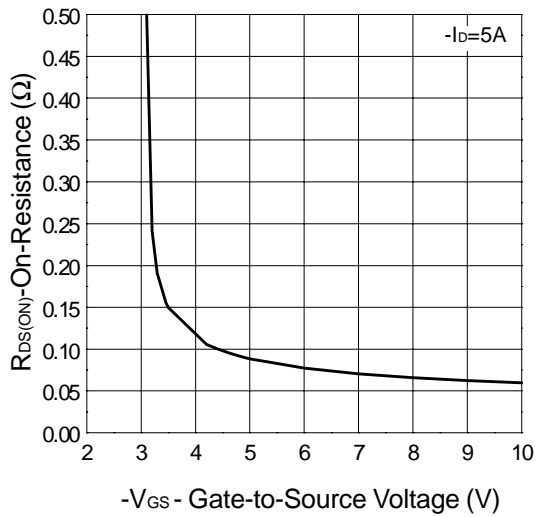

On-Resistance vs. Junction Temperature

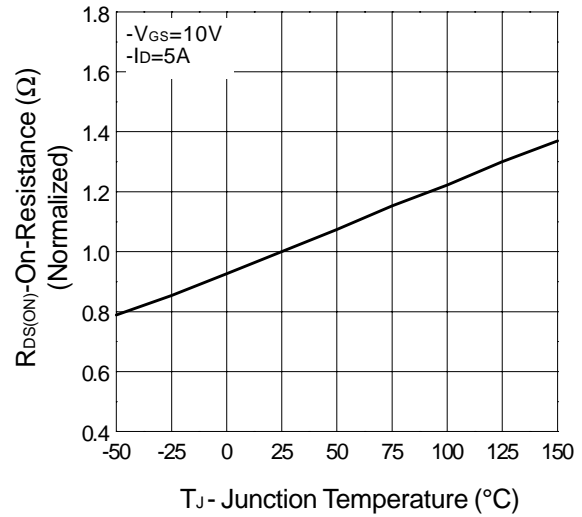

Gate Charge

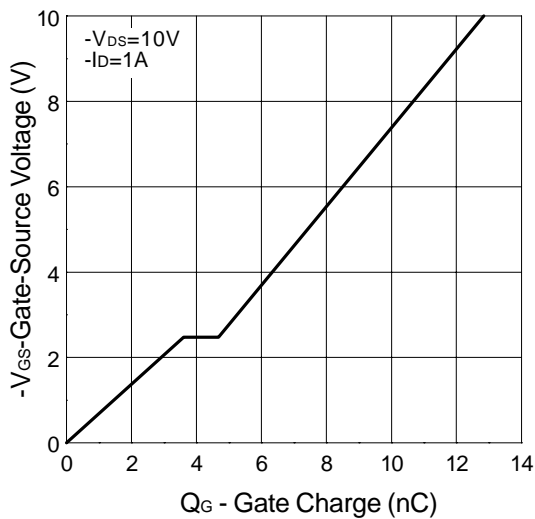

Capacitance

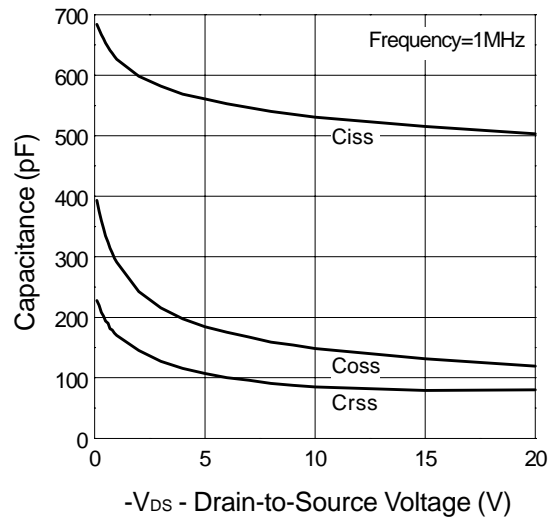



## Typical Characteristics (Cont.)

P-Channel

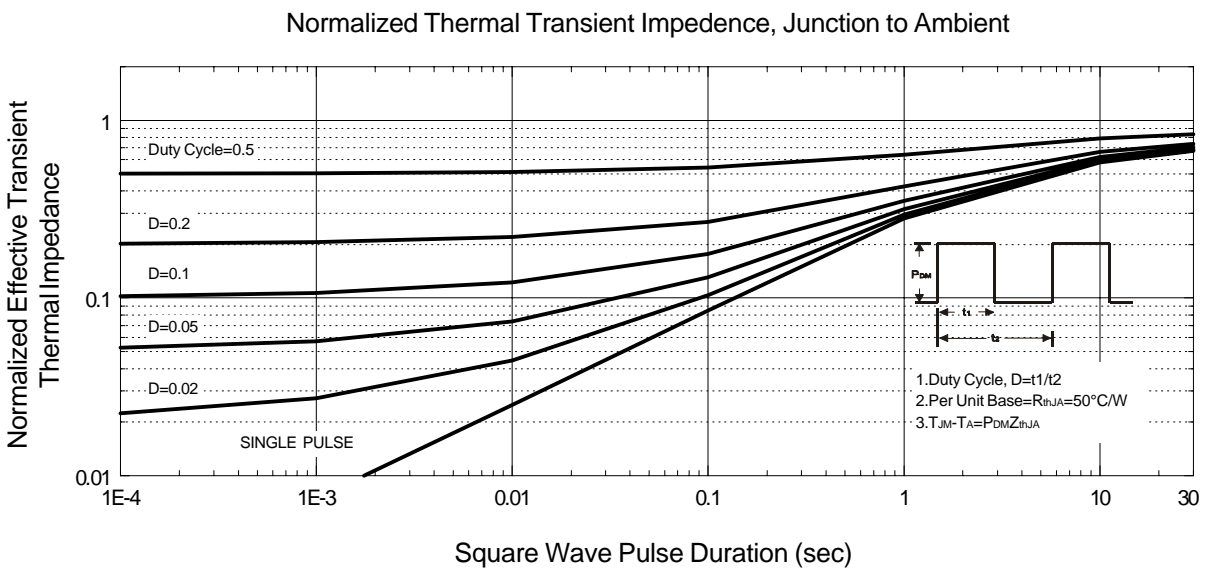
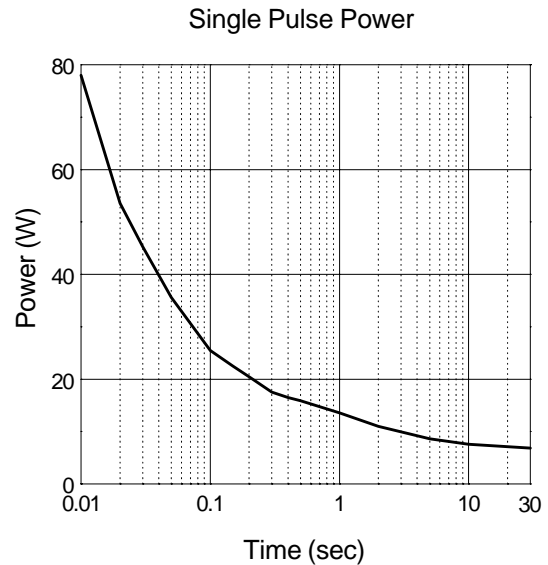
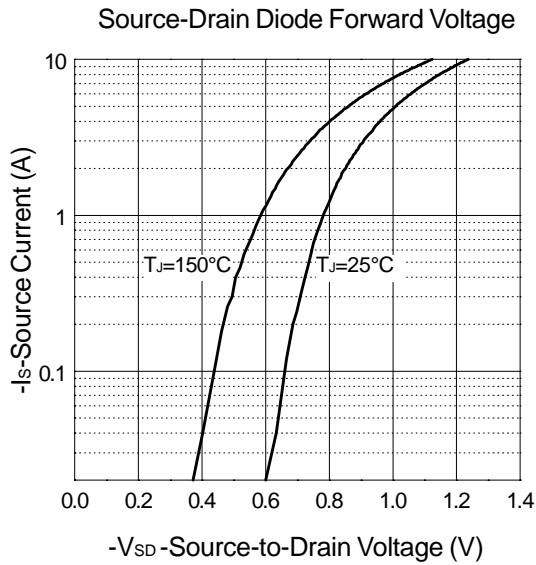

## Packaging Information

SOP-8 pin ( Reference JEDEC Registration MS-012)

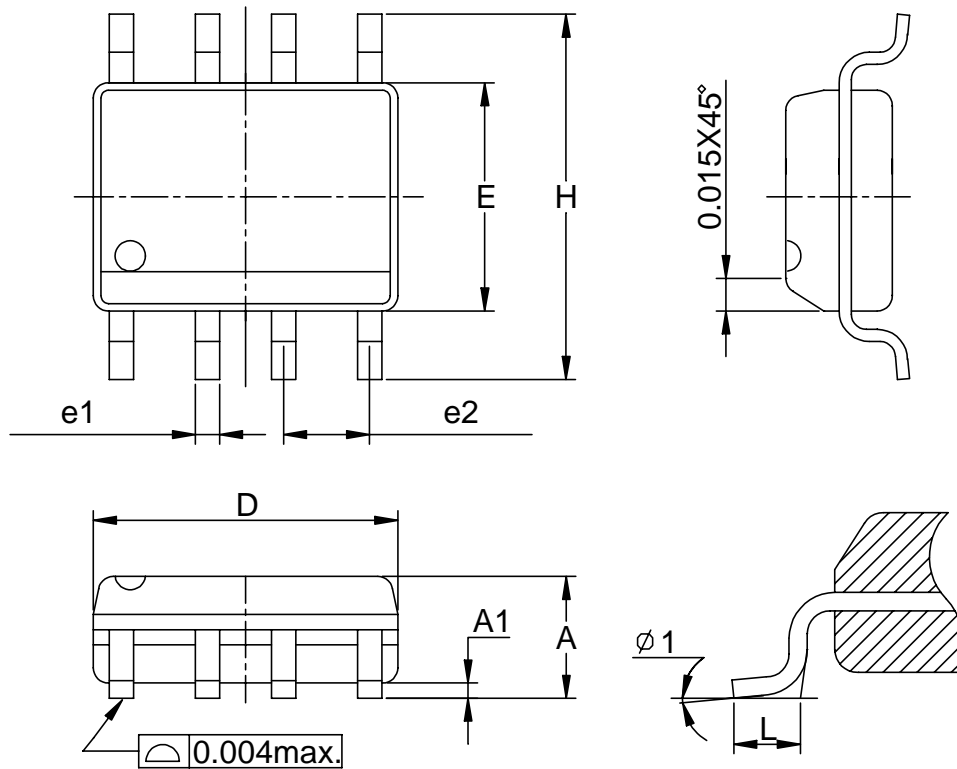

Dim	Millimeters		Inches	
	Min.	Max.	Min.	Max.
A	1.35	1.75	0.053	0.069
A1	0.10	0.25	0.004	0.010
D	4.80	5.00	0.189	0.197
E	3.80	4.00	0.150	0.157
H	5.80	6.20	0.228	0.244
L	0.40	1.27	0.016	0.050
e1	0.33	0.51	0.013	0.020
e2	1.27BSC		0.50BSC	
φ 1	8°		8°	

## Physical Specifications

Terminal Material	Solder-Plated Copper (Solder Material : 90/10 or 63/37 SnPb)
Lead Solderability	Meets EIA Specification RSI86-91, ANSI/J-STD-002 Category 3.

## Reflow Condition (IR/Convection or VPR Reflow)

Reference JEDEC Standard J-STD-020A APRIL 1999

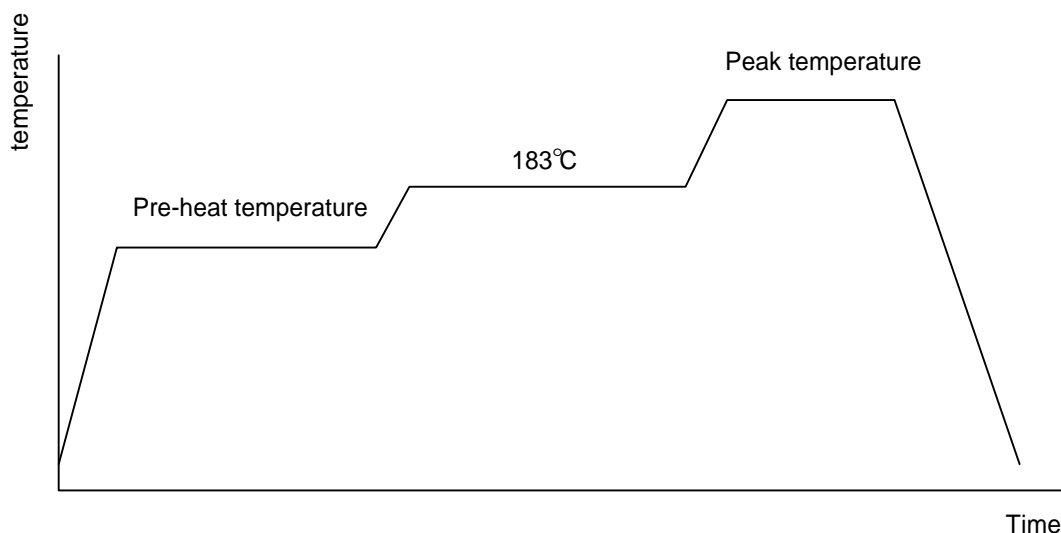

## Classification Reflow Profiles

	Convection or IR/ Convection	VPR
Average ramp-up rate(183°C to Peak)	3°C/second max.	10 °C /second max.
Preheat temperature 125 ± 25°C)	120 seconds max	
Temperature maintained above 183°C	60 – 150 seconds	
Time within 5°C of actual peak temperature	10 –20 seconds	60 seconds
Peak temperature range	220 +5/-0°C or 235 +5/-0°C	215-219°C or 235 +5/-0°C
Ramp-down rate	6 °C /second max.	10 °C /second max.
Time 25°C to peak temperature	6 minutes max.	

## Package Reflow Conditions

pkg. thickness ≥ 2.5mm and all bgas	pkg. thickness < 2.5mm and pkg. volume ≥ 350 mm <sup>3</sup>	pkg. thickness < 2.5mm and pkg. volume < 350mm <sup>3</sup>
Convection 220 +5/-0 °C		Convection 235 +5/-0 °C
VPR 215-219 °C		VPR 235 +5/-0 °C
IR/Convection 220 +5/-0 °C		IR/Convection 235 +5/-0 °C

## Reliability test program

Test item	Method	Description
SOLDERABILITY	MIL-STD-883D-2003	245°C, 5 SEC
HOLT	MIL-STD 883D-1005.7	1000 Hrs Bias @ 125°C
PCT	JESD-22-B, A102	168 Hrs, 100% RH, 121°C
TST	MIL-STD 883D-1011.9	-65°C ~ 150°C, 200 Cycles

## Carrier Tape & Reel Dimensions

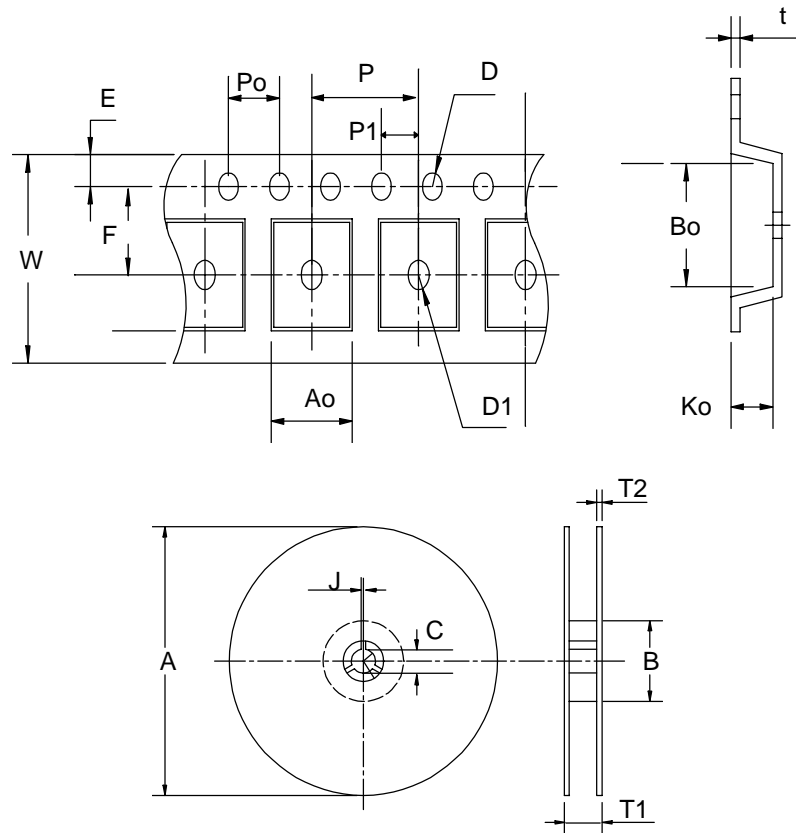

Application	A	B	C	J	T1	T2	W	P	E
SOP- 8	330 ± 1	62 +1.5	12.75+ 0.15	2 ± 0.5	12.4 ± 0.2	2 ± 0.2	12 ± 0.3	8 ± 0.1	1.75 ± 0.1
	F	D	D1	Po	P1	Ao	Bo	Ko	t
	5.5 ± 1	1.55 +0.1	1.55 + 0.25	4.0 ± 0.1	2.0 ± 0.1	6.4 ± 0.1	5.2 ± 0.1	2.1 ± 0.1	0.3 ± 0.013

## Cover Tape Dimensions

Application	Carrier Width	Cover Tape Width	Devices Per Reel
SOP- 8	12	9.3	2500

## Customer Service

### **Anpec Electronics Corp.**

#### Head Office :

5F, No. 2 Li-Hsin Road, SBIP,

Hsin-Chu, Taiwan, R.O.C.

Tel : 886-3-5642000

Fax : 886-3-5642050

#### Taipei Branch :

7F, No. 137, Lane 235, Pac Chiao Rd.,

Hsin Tien City, Taipei Hsien, Taiwan, R. O. C.

Tel : 886-2-89191368

Fax : 886-2-89191369