



APT10050B2VR

1000V 21A 0.500Ω

POWER MOS V[®]

Power MOS V[®] is a new generation of high voltage N-Channel enhancement mode power MOSFETs. This new technology minimizes the JFET effect, increases packing density and reduces the on-resistance. Power MOS V[®] also achieves faster switching speeds through optimized gate layout.

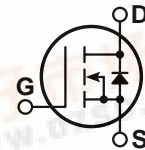
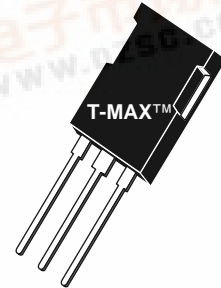

- **Faster Switching**
- **100% Avalanche Tested**
- **Lower Leakage**
- **New T-MAX[™] Package**
(Clip-mounted TO-247 Package)

MAXIMUM RATINGS

All Ratings: T_C = 25°C unless otherwise specified.

Symbol	Parameter	APT10050B2VR	UNIT
V _{DSS}	Drain-Source Voltage	1000	Volts
I _D	Continuous Drain Current @ T _C = 25°C	21	Amps
I _{DM}	Pulsed Drain Current ^①	84	
V _{GS}	Gate-Source Voltage Continuous	±30	Volts
V _{GSM}	Gate-Source Voltage Transient	±40	
P _D	Total Power Dissipation @ T _C = 25°C	520	Watts
	Linear Derating Factor	4.16	W/°C
T _J , T _{STG}	Operating and Storage Junction Temperature Range	-55 to 150	°C
T _L	Lead Temperature: 0.063" from Case for 10 Sec.	300	
I _{AR}	Avalanche Current ^① (Repetitive and Non-Repetitive)	21	Amps
E _{AR}	Repetitive Avalanche Energy ^①	50	mJ
E _{AS}	Single Pulse Avalanche Energy ^④	2500	

STATIC ELECTRICAL CHARACTERISTICS

Symbol	Characteristic / Test Conditions	MIN	TYP	MAX	UNIT
BV _{DSS}	Drain-Source Breakdown Voltage (V _{GS} = 0V, I _D = 250μA)	1000			Volts
I _{D(on)}	On State Drain Current ^② (V _{DS} > I _{D(on)} × R _{DS(on)} Max, V _{GS} = 10V)	21			Amps
R _{DS(on)}	Drain-Source On-State Resistance ^② (V _{GS} = 10V, 0.5 I _{D(Cont.)})			0.500	Ohms
I _{DSS}	Zero Gate Voltage Drain Current (V _{DS} = V _{DSS} , V _{GS} = 0V)			25	μA
	Zero Gate Voltage Drain Current (V _{DS} = 0.8 V _{DSS} , V _{GS} = 0V, T _C = 125°C)			250	
I _{GSS}	Gate-Source Leakage Current (V _{GS} = ±30V, V _{DS} = 0V)			±100	nA
V _{GS(th)}	Gate Threshold Voltage (V _{DS} = V _{GS} , I _D = 2.5mA)	2		4	Volts

CAUTION: These Devices are Sensitive to Electrostatic Discharge. Proper Handling Procedures Should Be Followed.

APT Website - <http://www.advancedpower.com>

DYNAMIC CHARACTERISTICS

APT10050B2VR

Symbol	Characteristic	Test Conditions	MIN	TYP	MAX	UNIT
C_{iss}	Input Capacitance	$V_{GS} = 0V$ $V_{DS} = 25V$ $f = 1 \text{ MHz}$		6600	7900	pF
C_{oss}	Output Capacitance			595	830	
C_{rss}	Reverse Transfer Capacitance			290	430	
Q_g	Total Gate Charge ③	$V_{GS} = 10V$ $V_{DD} = 0.5 V_{DSS}$ $I_D = I_{D[Cont.]} @ 25^\circ C$		335	500	nC
Q_{gs}	Gate-Source Charge			29	45	
Q_{gd}	Gate-Drain ("Miller") Charge			165	250	
$t_{d(on)}$	Turn-on Delay Time	$V_{GS} = 15V$ $V_{DD} = 0.5 V_{DSS}$ $I_D = I_{D[Cont.]} @ 25^\circ C$ $R_G = 0.6\Omega$		16	32	ns
t_r	Rise Time			13	26	
$t_{d(off)}$	Turn-off Delay Time			59	90	
t_f	Fall Time			8	16	

SOURCE-DRAIN DIODE RATINGS AND CHARACTERISTICS

Symbol	Characteristic / Test Conditions	MIN	TYP	MAX	UNIT
I_S	Continuous Source Current (Body Diode)			21	Amps
I_{SM}	Pulsed Source Current ① (Body Diode)			84	
V_{SD}	Diode Forward Voltage ② ($V_{GS} = 0V, I_S = -I_{D[Cont.]}$)			1.3	Volts
t_{rr}	Reverse Recovery Time ($I_S = -I_{D[Cont.]}, di_S/dt = 100A/\mu s$)		960		ns
Q_{rr}	Reverse Recovery Charge ($I_S = -I_{D[Cont.]}, di_S/dt = 100A/\mu s$)		22		μC

THERMAL CHARACTERISTICS

Symbol	Characteristic	MIN	TYP	MAX	UNIT
$R_{\theta JC}$	Junction to Case			0.24	$^\circ C/W$
$R_{\theta JA}$	Junction to Ambient			40	

① Repetitive Rating: Pulse width limited by maximum junction temperature.

② Pulse Test: Pulse width < 380 μs , Duty Cycle < 2%

③ See MIL-STD-750 Method 3471

④ Starting $T_j = +25^\circ C$, $L = 11.34mH$, $R_G = 25\Omega$, Peak $I_L = 21A$

⑤ These dimensions are equal to the TO-247AD without mounting hole

APT Reserves the right to change, without notice, the specifications and information contained herein.

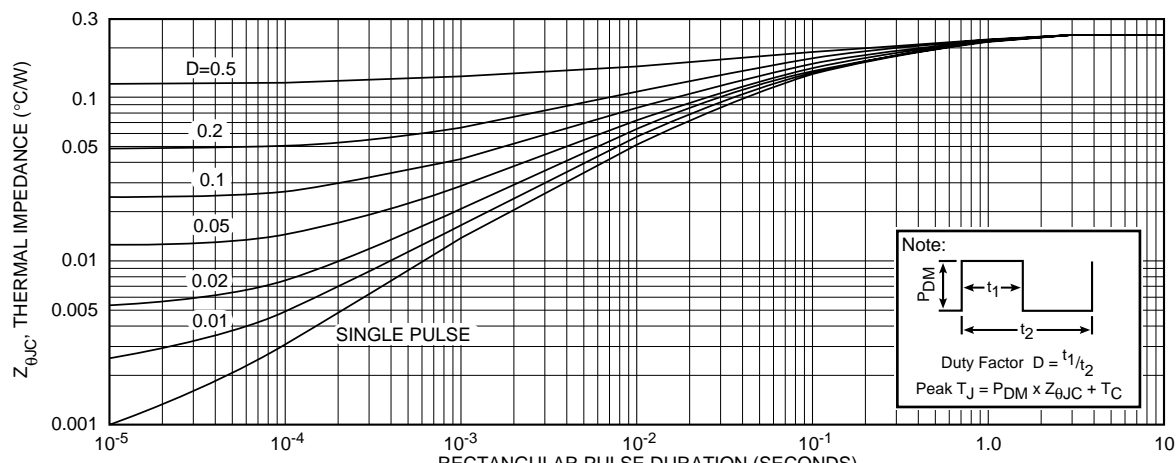

APT10050B2VR

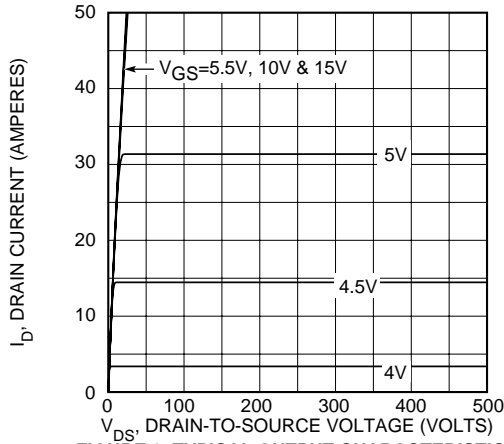

FIGURE 2, TYPICAL OUTPUT CHARACTERISTICS

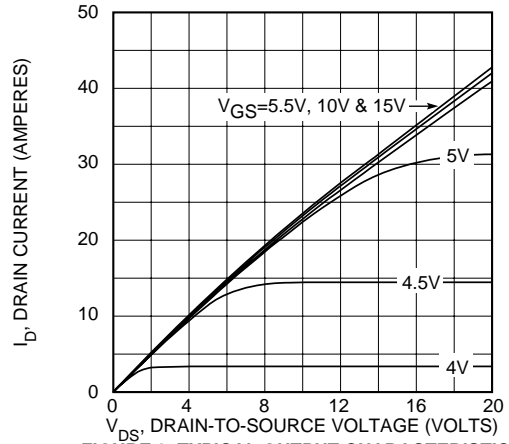

FIGURE 3, TYPICAL OUTPUT CHARACTERISTICS

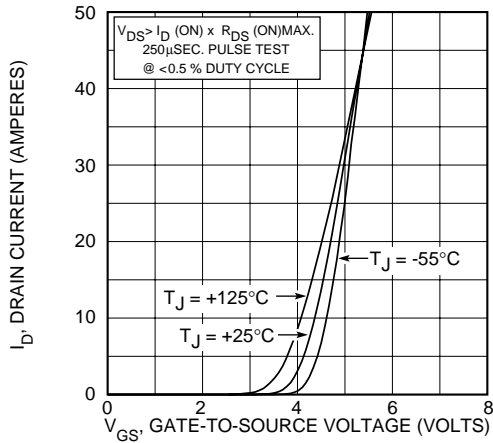

FIGURE 4, TYPICAL TRANSFER CHARACTERISTICS

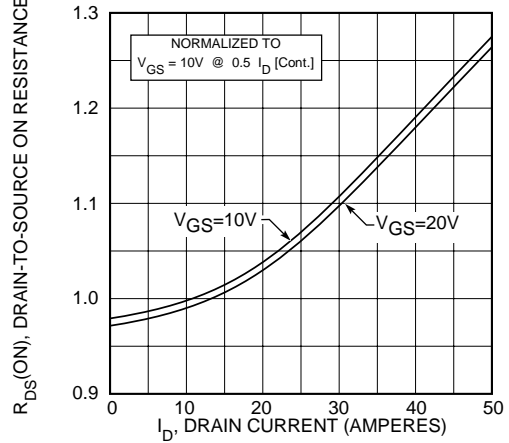

FIGURE 5, $R_{DS(ON)}$ vs DRAIN CURRENT

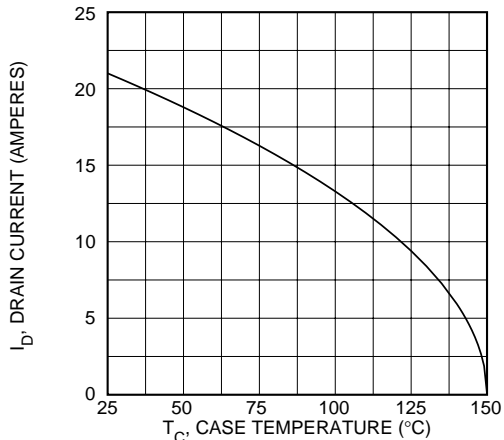

FIGURE 6, MAXIMUM DRAIN CURRENT vs CASE TEMPERATURE

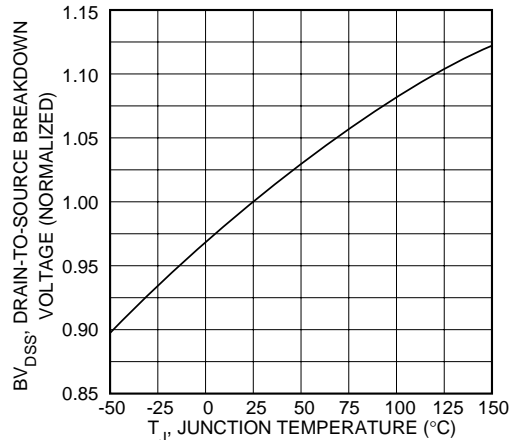

FIGURE 7, BREAKDOWN VOLTAGE vs TEMPERATURE

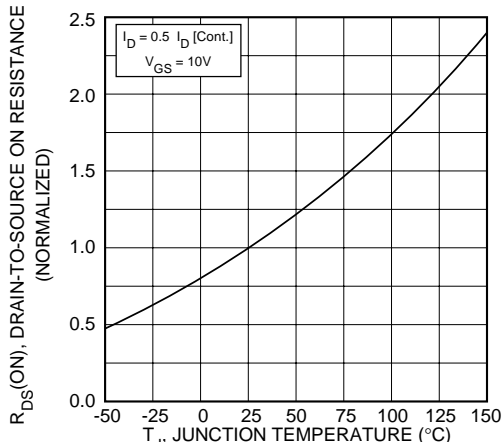

FIGURE 8, ON-RESISTANCE vs. TEMPERATURE

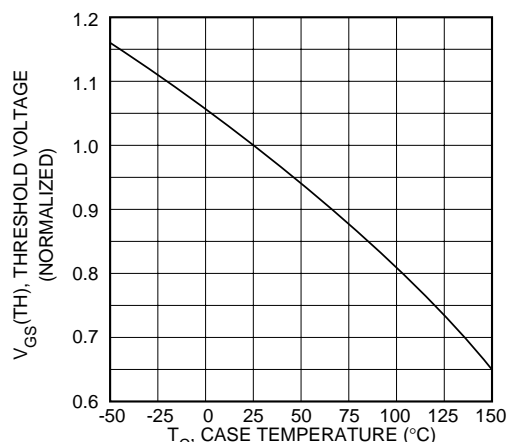

FIGURE 9, THRESHOLD VOLTAGE vs TEMPERATURE

APT10050B2VR

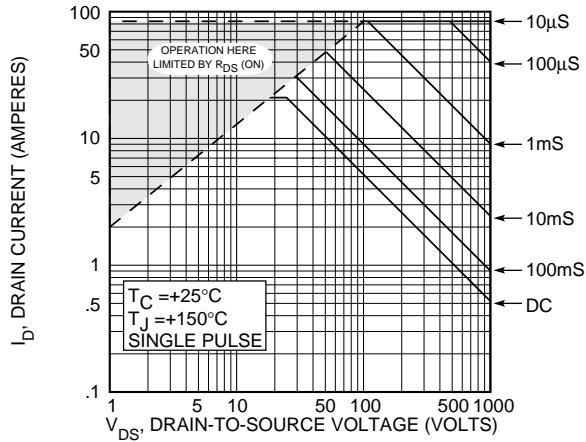

FIGURE 10, MAXIMUM SAFE OPERATING AREA

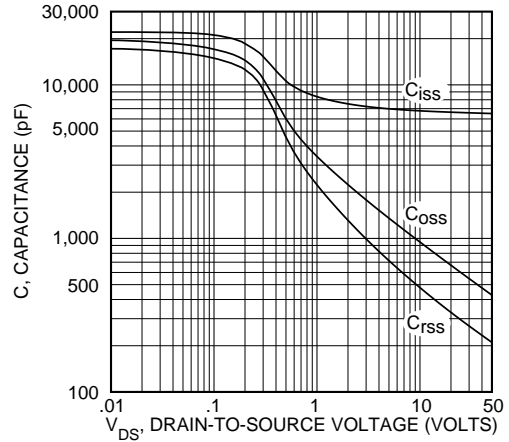

FIGURE 11, TYPICAL CAPACITANCE vs DRAIN-TO-SOURCE VOLTAGE

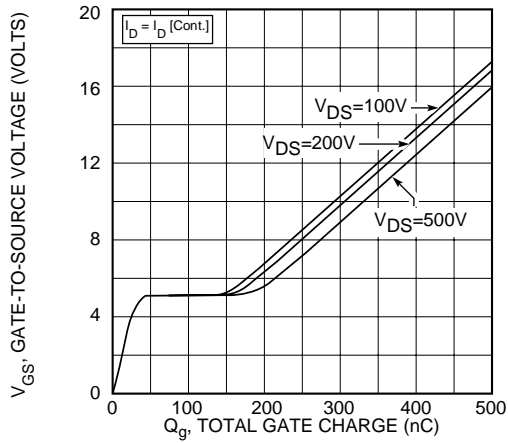

FIGURE 12, GATE CHARGES vs GATE-TO-SOURCE VOLTAGE

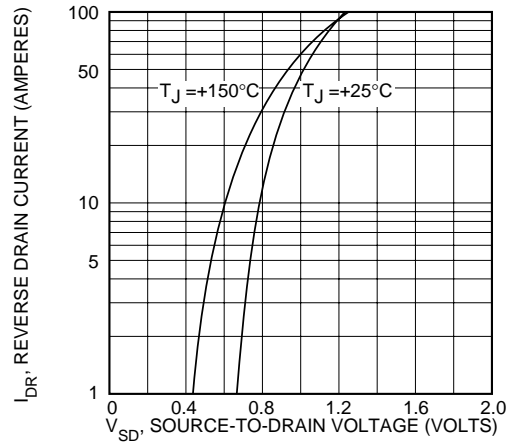
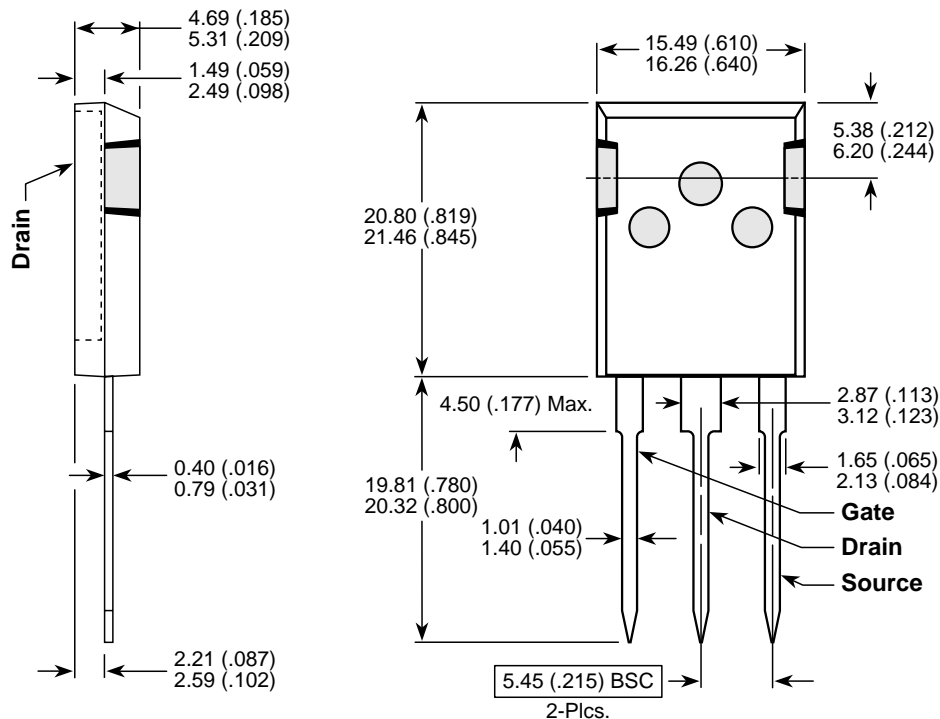

FIGURE 13, TYPICAL SOURCE-DRAIN DIODE FORWARD VOLTAGE

T-MAX™ Package Outline ⑤



Dimensions in Millimeters and (Inches)