

[查询APT15D60BCT供应商](#)

[捷多邦, 专业PCB打样工厂, 24小时加急出货](#)

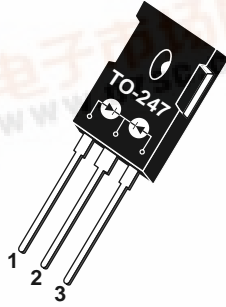
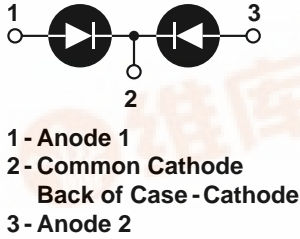

**APT15D60BCT 600V 2x15A**

## ULTRAFast SOFT RECOVERY RECTIFIER DIODES

PRODUCT APPLICATIONS	PRODUCT FEATURES	PRODUCT BENEFITS
<ul style="list-style-type: none"> <li>• Parallel Diode               <ul style="list-style-type: none"> <li>-Switchmode Power Supply</li> <li>-Inverters</li> </ul> </li> <li>• Free Wheeling Diode               <ul style="list-style-type: none"> <li>-Motor Controllers</li> <li>-Converters</li> </ul> </li> <li>• Snubber Diode</li> <li>• Uninterruptible Power Supply (UPS)</li> <li>• Induction Heating</li> <li>• High Speed Rectifiers</li> </ul>	<ul style="list-style-type: none"> <li>• Ultrafast Recovery Times</li> <li>• Soft Recovery Characteristics</li> <li>• Popular TO-247 Package</li> <li>• Low Forward Voltage</li> <li>• High Blocking Voltage</li> <li>• Low Leakage Current</li> </ul>	<ul style="list-style-type: none"> <li>• Low Losses</li> <li>• Low Noise Switching</li> <li>• Cooler Operation</li> <li>• Higher Reliability Systems</li> <li>• Increased System Power Density</li> </ul>

### MAXIMUM RATINGS

All Ratings Are Per Leg:  $T_C = 25^\circ\text{C}$  unless otherwise specified.

Symbol	Characteristic / Test Conditions	APT15D60BCT	UNIT
$V_R$	Maximum D.C. Reverse Voltage	600	Volts
$V_{RRM}$	Maximum Peak Repetitive Reverse Voltage		
$V_{RWM}$	Maximum Working Peak Reverse Voltage		
$I_F(AV)$	Maximum Average Forward Current ( $T_C = 100^\circ\text{C}$ , Duty Cycle = 0.5)	15	Amps
$I_F(RMS)$	RMS Forward Current	25	
$I_{FSM}$	Non-Repetitive Forward Surge Current ( $T_J = 45^\circ\text{C}$ , 8.3ms)	110	
$T_J, T_{STG}$	Operating and Storage Temperature Range	-55 to 150	$^\circ\text{C}$
$T_L$	Lead Temperature: 0.063" from Case for 10 Sec.	300	

### STATIC ELECTRICAL CHARACTERISTICS

Symbol	Characteristic / Test Conditions	MIN	TYP	MAX	UNIT
$V_F$	Maximum Forward Voltage			1.8	Volts
				$I_F = 15\text{A}$	
				$I_F = 30\text{A}$	
$I_{RM}$	Maximum Reverse Leakage Current			1.6	$\mu\text{A}$
				$I_F = 15\text{A}, T_J = 150^\circ\text{C}$	
				$V_R = V_R \text{ Rated}$	
	$V_R = V_R \text{ Rated}, T_J = 125^\circ\text{C}$			500	
$C_T$	Junction Capacitance, $V_R = 200\text{V}$		16		pF
$L_S$	Series Inductance (Lead to Lead 5mm from Base)		10		nH

APT Website - <http://www.advancedpower.com>

405 S.W. Columbia Street  
EUROPE

Bend, Oregon 97702-1035

Phone: (541) 382-8028

FAX: (541) 388-0364

Avenue J.F. Kennedy, Bât B4 Parc Cadéra Nord

F-33700 Merignac - France

Phone: (33) 5 57 92 15 15

FAX: (33) 5 56 47 97 61

53-6015 Rev -

### DYNAMIC CHARACTERISTICS

APT15D60BCT

Symbol	Characteristic	MIN	TYP	MAX	UNIT
$t_{rr1}$	Reverse Recovery Time, $I_F = 1.0A$ , $di_F/dt = -15A/\mu s$ , $V_R = 30V$ , $T_J = 25^\circ C$		40	50	ns
$t_{rr2}$	Reverse Recovery Time		40		
$t_{rr3}$	$I_F = 15A$ , $di_F/dt = -100A/\mu s$ , $V_R = 350V$		80		
$t_{fr1}$	Forward Recovery Time		170		
$t_{fr2}$	$I_F = 15A$ , $di_F/dt = 100A/\mu s$ , $V_R = 350V$		170		
$I_{RRM1}$	Reverse Recovery Current		2.5	5	Amps
$I_{RRM2}$	$I_F = 15A$ , $di_F/dt = -100A/\mu s$ , $V_R = 350V$		3	6	
$Q_{rr1}$	Recovery Charge		50		nC
$Q_{rr2}$	$I_F = 15A$ , $di_F/dt = -100A/\mu s$ , $V_R = 350V$		120		
$V_{fr1}$	Forward Recovery Voltage		2.2		Volts
$V_{fr2}$	$I_F = 15A$ , $di_F/dt = 100A/\mu s$ , $V_R = 350V$		2.2		
diM/dt	Rate of Fall of Recovery Current		200		A/ $\mu s$
	$I_F = 15A$ , $di_F/dt = -100A/\mu s$ , $V_R = 350V$ (See Figure 10)		100		

### THERMAL AND MECHANICAL CHARACTERISTICS

Symbol	Characteristic / Test Conditions	MIN	TYP	MAX	UNIT
$R_{\theta JC}$	Junction-to-Case Thermal Resistance			1.7	$^\circ C/W$
$R_{\theta JA}$	Junction-to-Ambient Thermal Resistance			40	
$W_T$	Package Weight		0.22		oz
			6.1		gm
Torque	Maximum Mounting Torque (Screw Type = 6-32 or 3.5mm Machine)			10	lb•in
				1.1	N•m

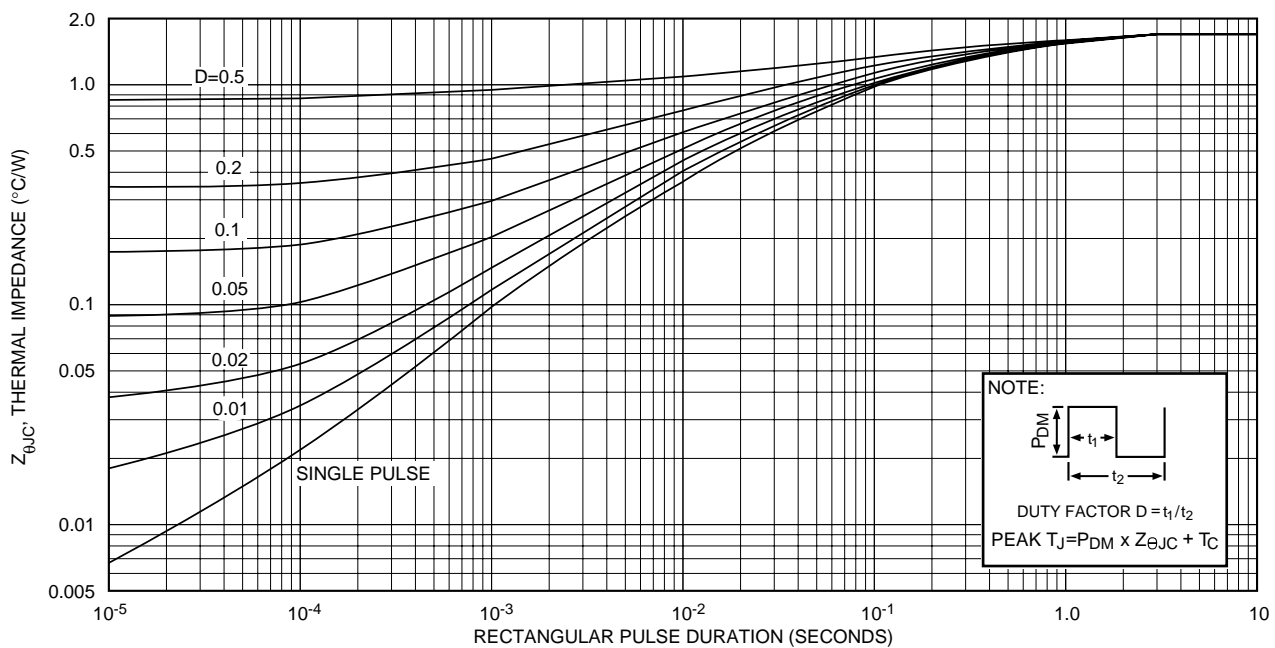

**APT15D60BCT**

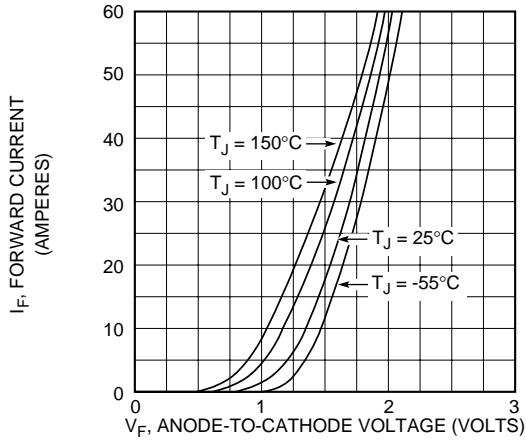

**Figure 2, Forward Voltage Drop vs Forward Current**

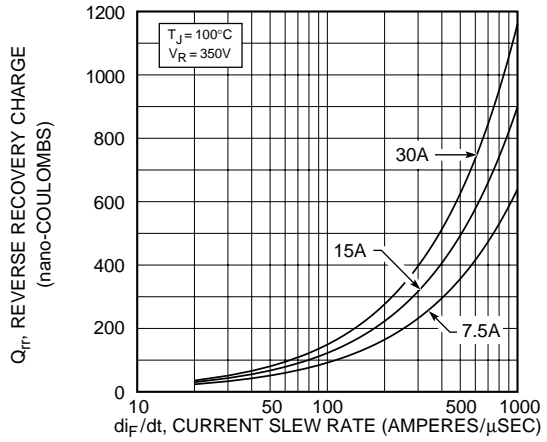

**Figure 3, Reverse Recovery Charge vs Current Slew Rate**

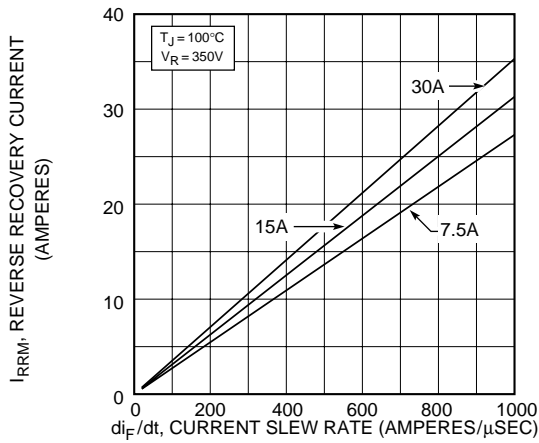

**Figure 4, Reverse Recovery Current vs Current Slew Rate**

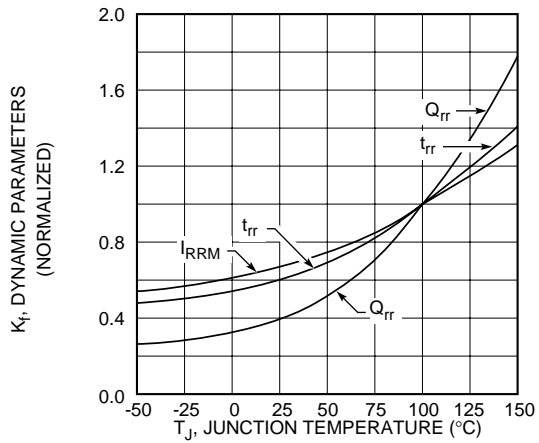

**Figure 5, Dynamic Parameters vs Junction Temperature**

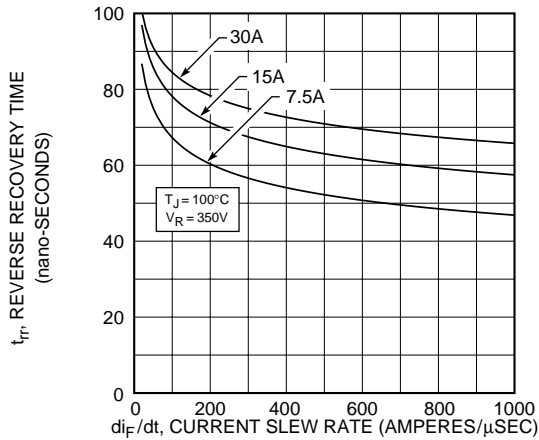

**Figure 6, Reverse Recovery Time vs Current Slew Rate**

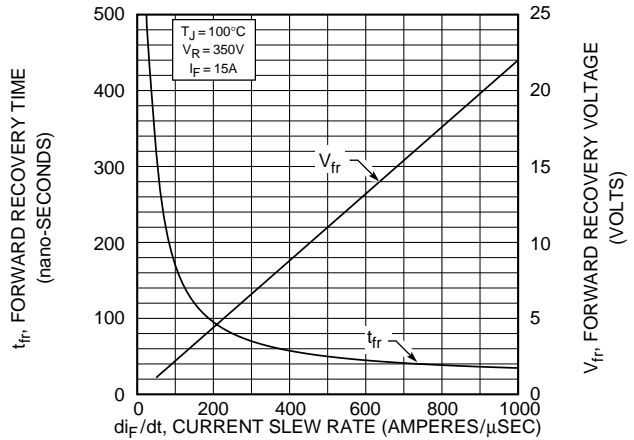

**Figure 7, Forward Recovery Voltage/Time vs Current Slew Rate**

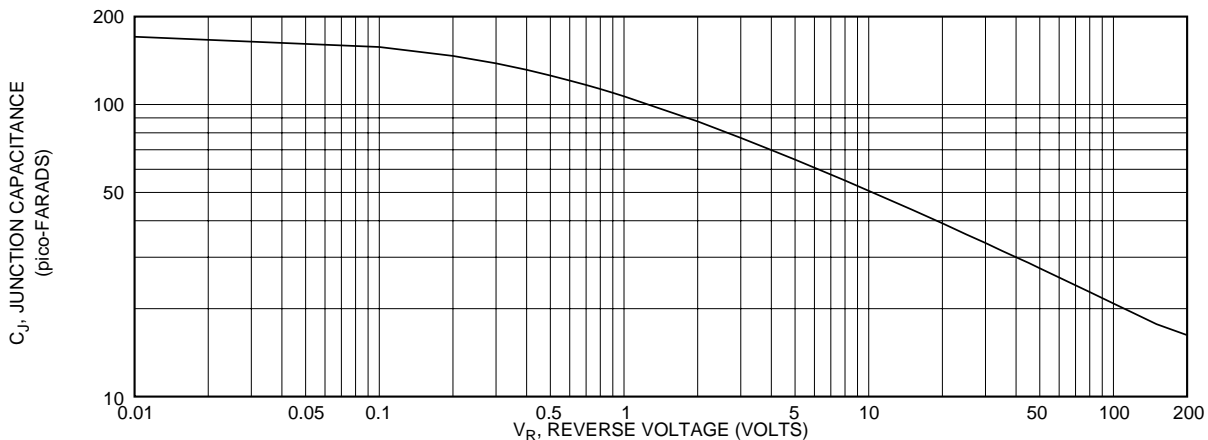

**Figure 8, Junction Capacitance vs Reverse Voltage**

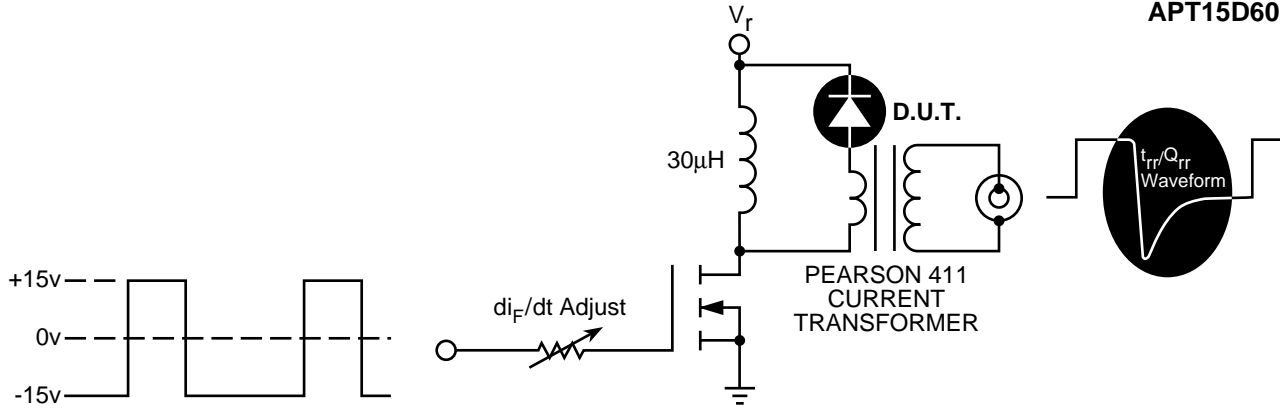

Figure 9, Diode Reverse Recovery Test Circuit and Waveforms

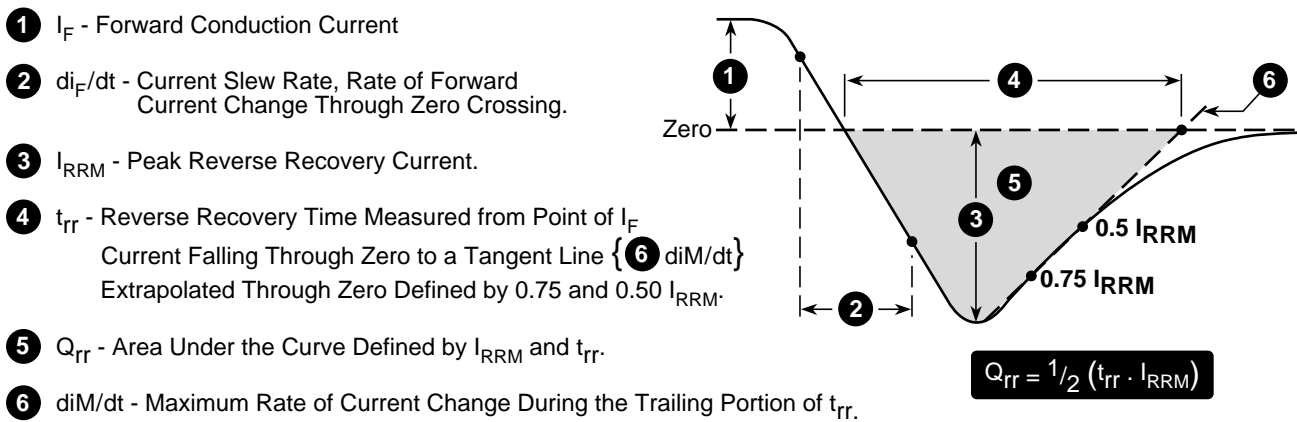

Figure 10, Diode Reverse Recovery Waveform and Definitions

### TO-247AD Package Outline

