

查询APT30D60S供应商

捷多邦, 专业PCB打样工厂, 24小时加急出货

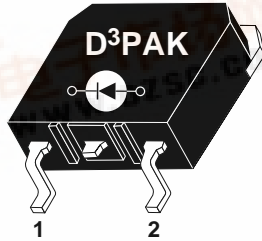

1 - Cathode
2 - Anode
Back of Case - Cathode



**ADVANCED
POWER
TECHNOLOGY®**
APT30D60S 600V 30A

ULTRAFAST SOFT RECOVERY RECTIFIER DIODE

PRODUCT APPLICATIONS

- Anti-Parallel Diode
 - Switchmode Power Supply
 - Inverters
- Free Wheeling Diode
 - Motor Controllers
 - Converters
- Snubber Diode
- Uninterruptible Power Supply (UPS)
- Induction Heating
- High Speed Rectifiers

PRODUCT FEATURES

- Ultrafast Recovery Times
- Soft Recovery Characteristics
- Surface Mount D³PAK Package
- Low Forward Voltage
- High Blocking Voltage
- Low Leakage Current

PRODUCT BENEFITS

- Low Losses
- Low Noise Switching
- Cooler Operation
- Higher Reliability Systems
- Increased System Power Density

MAXIMUM RATINGS

All Ratings: $T_C = 25^\circ\text{C}$ unless otherwise specified.

Symbol	Characteristic / Test Conditions	APT30D60S	UNIT
V_R	Maximum D.C. Reverse Voltage	600	Volts
V_{RRM}	Maximum Peak Repetitive Reverse Voltage		
V_{RWM}	Maximum Working Peak Reverse Voltage		
$I_F(AV)$	Maximum Average Forward Current ($T_C = 100^\circ\text{C}$, Duty Cycle = 0.5)	30	Amps
$I_F(RMS)$	RMS Forward Current	70	
I_{FSM}	Non-Repetitive Forward Surge Current ($T_J = 45^\circ\text{C}$, 8.3ms)	320	
T_J, T_{STG}	Operating and Storage Temperature Range	-55 to 150	$^\circ\text{C}$
T_L	Lead Temperature: 0.063" from Case for 10 Sec.	300	

STATIC ELECTRICAL CHARACTERISTICS

Symbol	Characteristic / Test Conditions	MIN	TYP	MAX	UNIT
V_F	Maximum Forward Voltage			1.8	Volts
				$I_F = 30\text{A}$	
				$I_F = 60\text{A}$	
I_{RM}	Maximum Reverse Leakage Current			1.6	μA
				$V_R = V_R$ Rated	
				$V_R = V_R$ Rated, $T_J = 125^\circ\text{C}$	
C_T	Junction Capacitance, $V_R = 200\text{V}$		40		pF
L_S	Series Inductance (Lead to Lead 5mm from Base)		10		nH

APT Website - <http://www.advancedpower.com>

405 S.W. Columbia Street

Bend, Oregon 97702-1035

Phone: (541) 382-8028

FAX: (541) 388-0364

Avenue J.F. Kennedy, Bât B4 Parc Cadéra Nord

F-33700 Merignac - France

Phone: (33) 5 57 92 15 15

FAX: (33) 5 56 47 97 61

DYNAMIC CHARACTERISTICS

APT30D60S

Symbol	Characteristic	MIN	TYP	MAX	UNIT
t_{rr1}	Reverse Recovery Time, $I_F = 1.0A$, $di_F/dt = -15A/\mu s$, $V_R = 30V$, $T_J = 25^\circ C$		50	65	ns
t_{rr2}	Reverse Recovery Time	$T_J = 25^\circ C$	50		
t_{rr3}	$I_F = 30A$, $di_F/dt = -240A/\mu s$, $V_R = 350V$	$T_J = 100^\circ C$	80		
t_{fr1}	Forward Recovery Time	$T_J = 25^\circ C$	155		
t_{fr2}	$I_F = 30A$, $di_F/dt = 240A/\mu s$, $V_R = 350V$	$T_J = 100^\circ C$	155		
I_{RRM1}	Reverse Recovery Current	$T_J = 25^\circ C$	4	10	Amps
I_{RRM2}	$I_F = 30A$, $di_F/dt = -240A/\mu s$, $V_R = 350V$	$T_J = 100^\circ C$	7.5	15	
Q_{rr1}	Recovery Charge	$T_J = 25^\circ C$	100		nC
Q_{rr2}	$I_F = 30A$, $di_F/dt = -240A/\mu s$, $V_R = 350V$	$T_J = 100^\circ C$	300		
V_{fr1}	Forward Recovery Voltage	$T_J = 25^\circ C$	5		Volts
V_{fr2}	$I_F = 30A$, $di_F/dt = 240A/\mu s$, $V_R = 350V$	$T_J = 100^\circ C$	5		
diM/dt	Rate of Fall of Recovery Current	$T_J = 25^\circ C$	400		A/ μs
	$I_F = 30A$, $di_F/dt = -240A/\mu s$, $V_R = 350V$ (See Figure 10)	$T_J = 100^\circ C$	200		

THERMAL AND MECHANICAL CHARACTERISTICS

Symbol	Characteristic / Test Conditions	MIN	TYP	MAX	UNIT
$R_{\theta JC}$	Junction-to-Case Thermal Resistance			0.90	$^\circ C/W$
$R_{\theta JA}$	Junction-to-Ambient Thermal Resistance			40	
W_T	Package Weight		0.14		oz
			3.9		gm

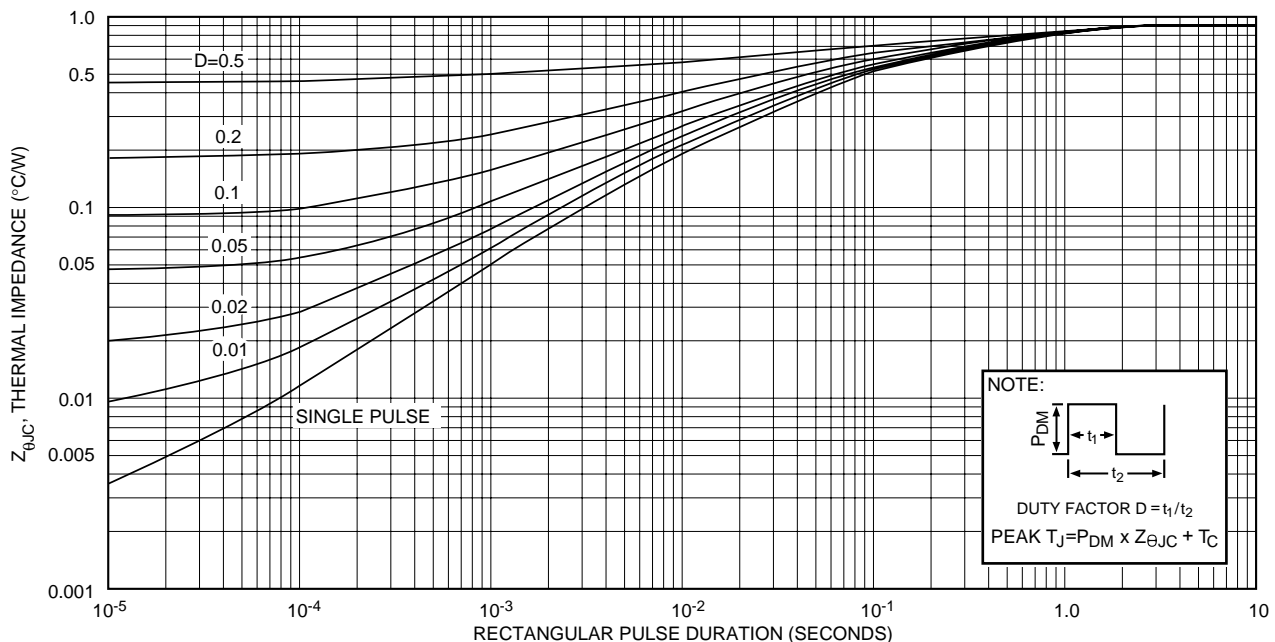

APT30D60S

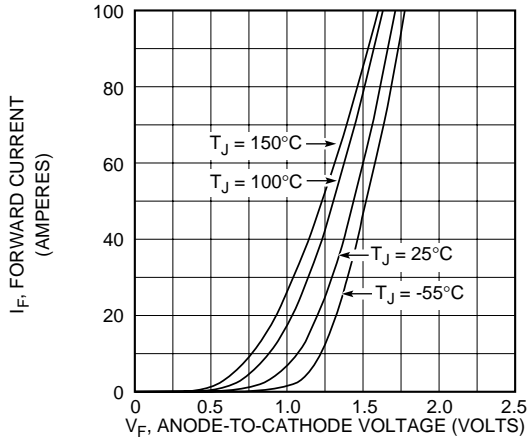

Figure 2, Forward Voltage Drop vs Forward Current

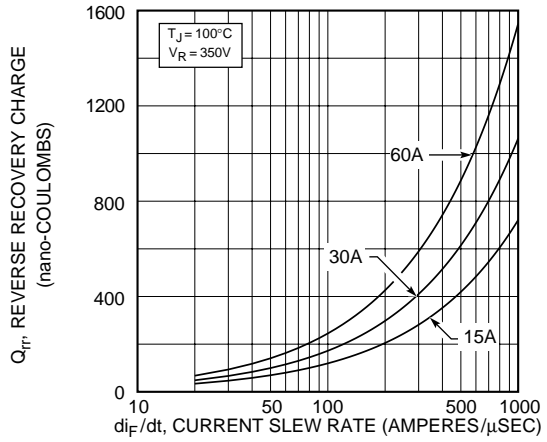

Figure 3, Reverse Recovery Charge vs Current Slew Rate

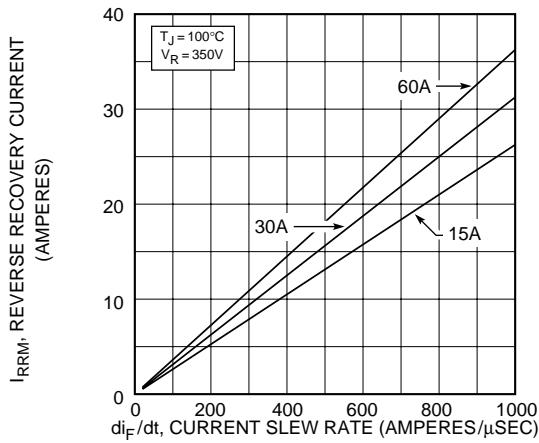

Figure 4, Reverse Recovery Current vs Current Slew Rate

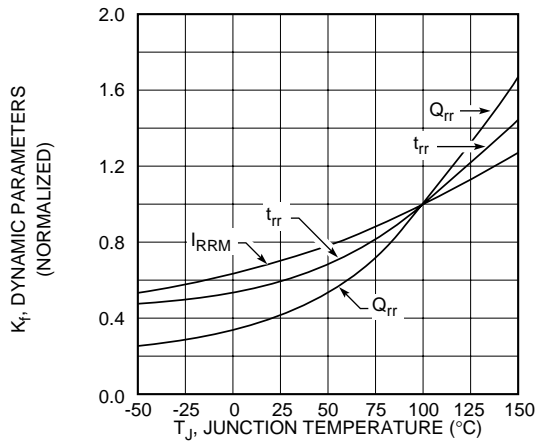

Figure 5, Dynamic Parameters vs Junction Temperature

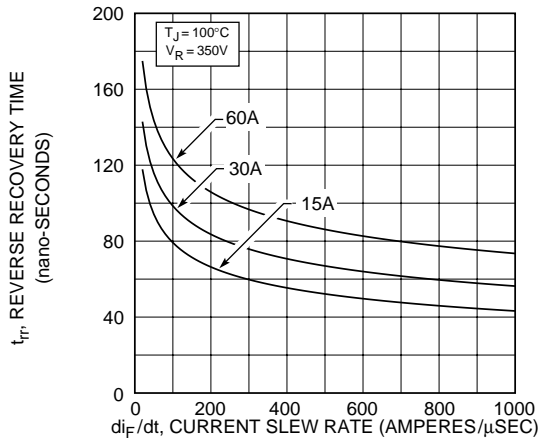

Figure 6, Reverse Recovery Time vs Current Slew Rate

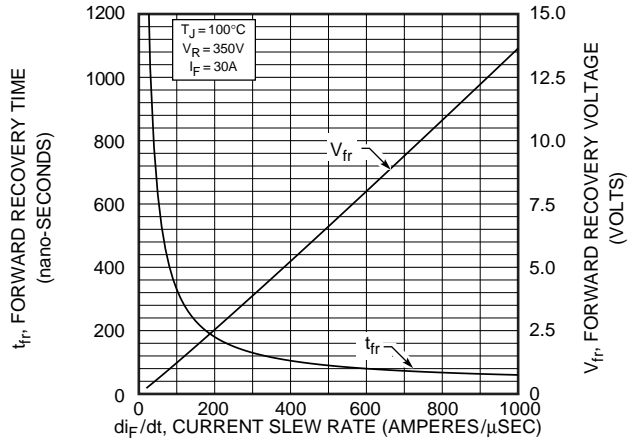

Figure 7, Forward Recovery Voltage/Time vs Current Slew Rate

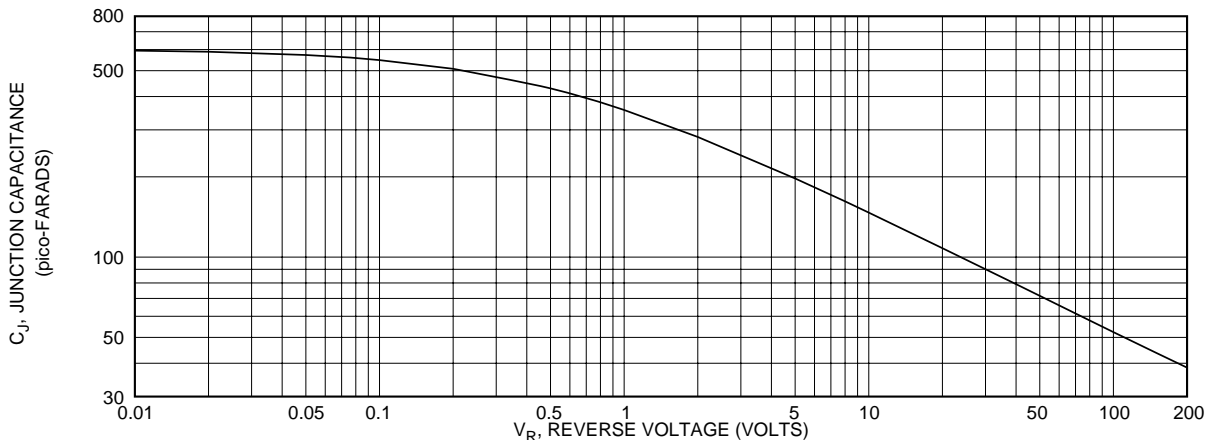

Figure 8, Junction Capacitance vs Reverse Voltage

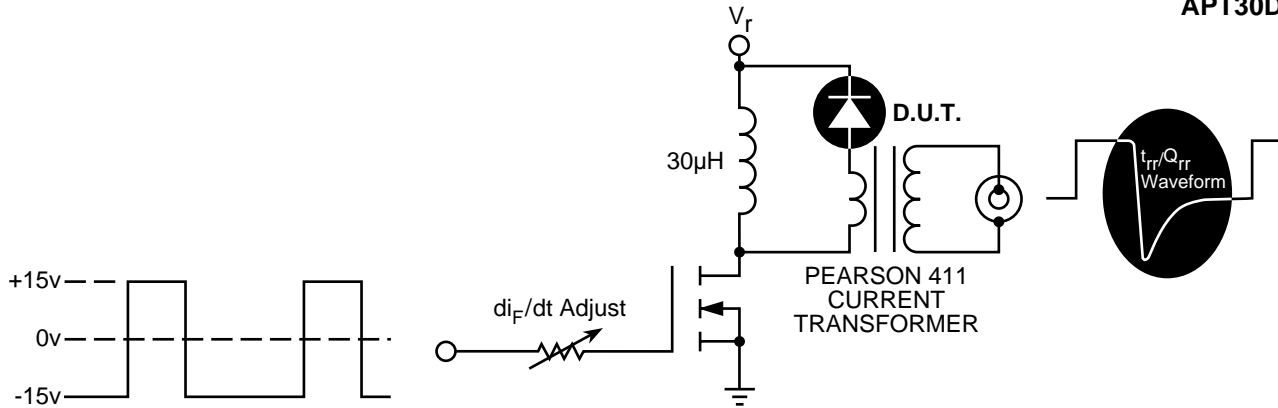

Figure 9, Diode Reverse Recovery Test Circuit and Waveforms

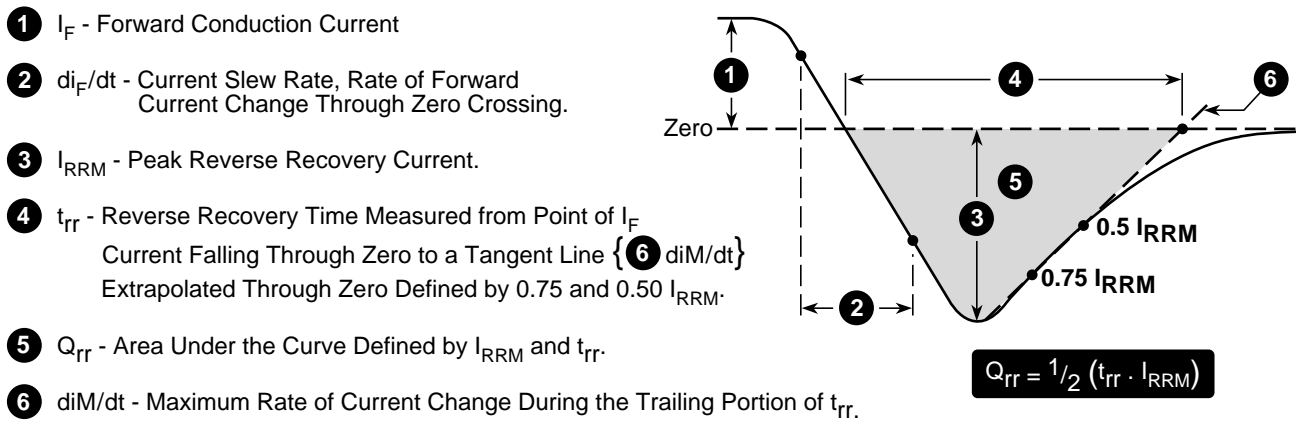
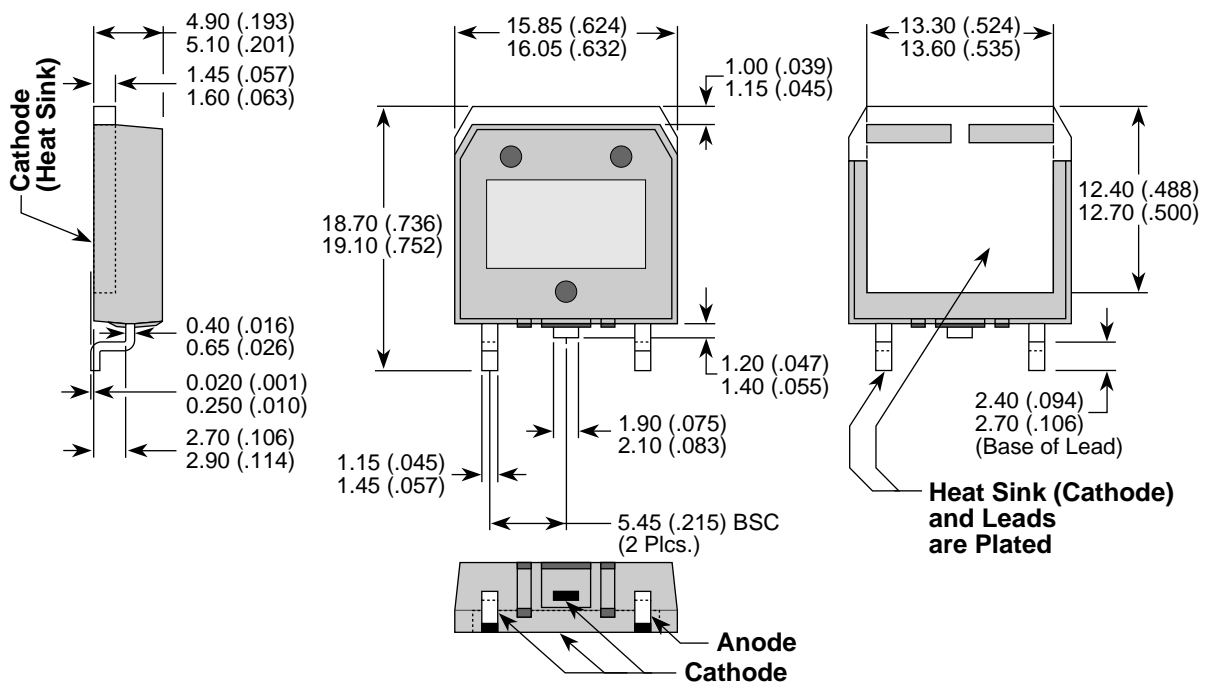

Figure 10, Diode Reverse Recovery Waveform and Definitions

APT Reserves the right to change, without notice, the specifications and information contained herein.

D³PAK Package Outline



Dimensions in Millimeters (Inches)