

[查询AR2004供应商](#)

[维库电子市场网](#) 专业PCB打样工厂, 24小时加急出货



POSEICO SPA

Power SEmiconductors Italian COporation

Via N. Lorenzi 8, 16152 Genova - ITALY

Tel. ++ 39 010 6556234 - Fax ++ 39 010 6557519

Sales Office:

Tel. ++ 39 010 6556775 - Fax ++ 39 010 6442510

RECTIFIER DIODE

AR2004

Repetitive voltage up to **2400 V**
 Mean forward current **2525 A**
 Surge current **28 kA**

FINAL SPECIFICATION

nov 02 - ISSUE : 05

Symbol	Characteristic	Conditions	T _j [°C]	Value	Unit
BLOCKING					
V _{RRM}	Repetitive peak reverse voltage		175	2400	V
V _{RSM}	Non-repetitive peak reverse voltage		175	2500	V
I _{RRM}	Repetitive peak reverse current	V=VRRM	175	50	mA
CONDUCTING					
I _{F(AV)}	Mean forward current	180° sin ,50 Hz, Th=55°C, double side cooled		2525	A
I _{F(AV)}	Mean forward current	180° sin ,50 Hz, Tc=85°C, double side cooled		2485	A
I _{FSM}	Surge forward current	Sine wave, 10 ms without reverse voltage	175	28	kA
I ² t	I ² t			3920 x 1E3	A ² s
V _{FM}	Forward voltage	Forward current = 3400 A	25	1.30	V
V _{F(TO)}	Threshold voltage		175	0.80	V
r _F	Forward slope resistance		175	0.165	mohm
SWITCHING					
t _{rr}	Reverse recovery time				µs
Q _{rr}	Reverse recovery charge		175		µC
I _{rr}	Peak reverse recovery current				A
MOUNTING					
R _{th(j-h)}	Thermal impedance, DC	Junction to heatsink, double side cooled		26	°C/kW
R _{th(c-h)}	Thermal impedance	Case to heatsink, double side cooled		6	°C/kW
T _j	Operating junction temperature			-30 / 175	°C
F	Mounting force			18.0 / 20.0	kN
	Mass			500	g

ORDERING INFORMATION : AR2004 S 24

standard specification VRRM/100



pdf.dzsc.com

DISSIPATION CHARACTERISTICS

SQUARE WAVE

Th [°C]

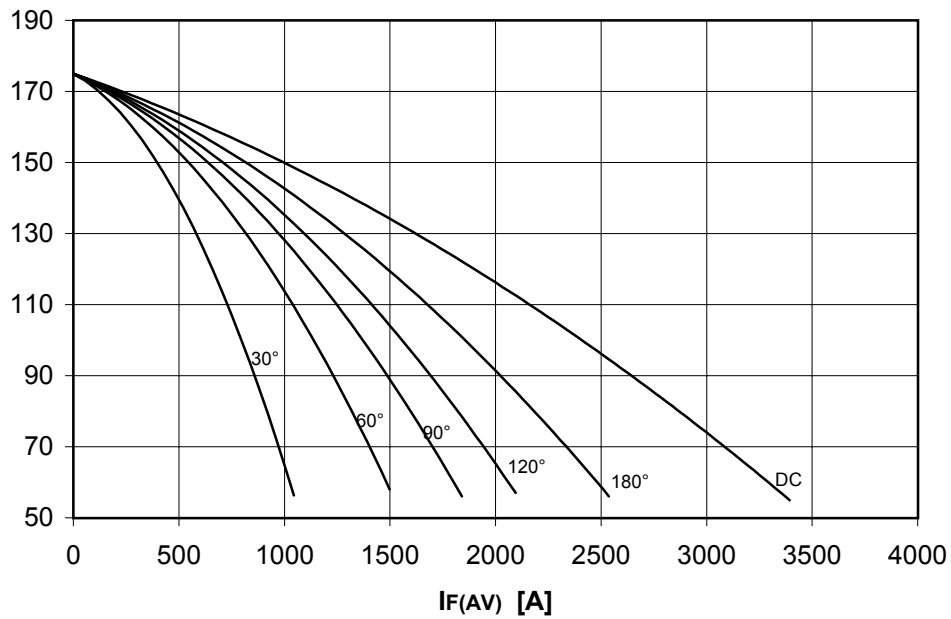

PF(AV) [W]

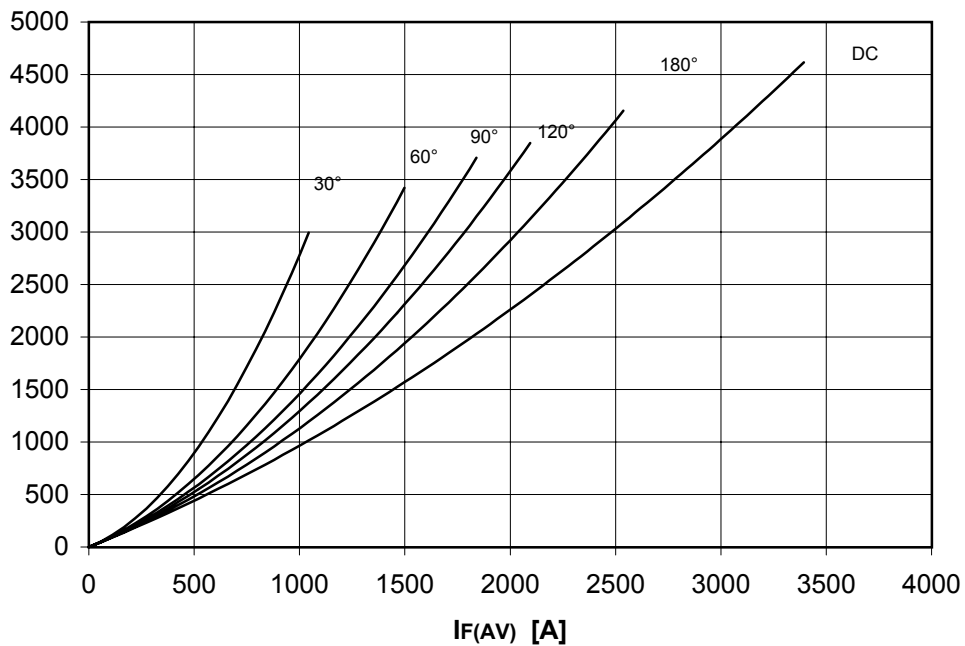

DISSIPATION CHARACTERISTICS

SINE WAVE

Th [°C]

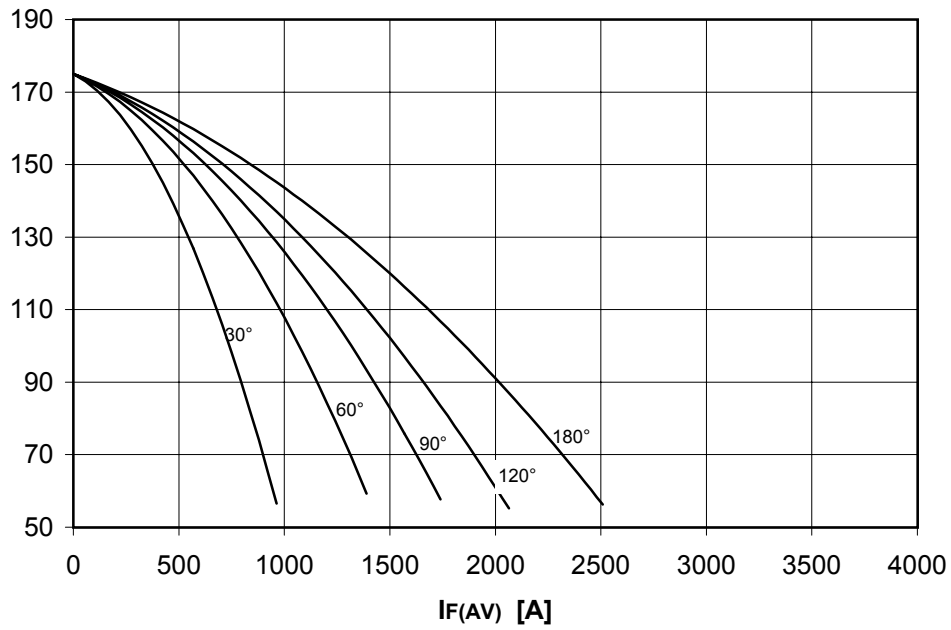

PF(AV) [W]

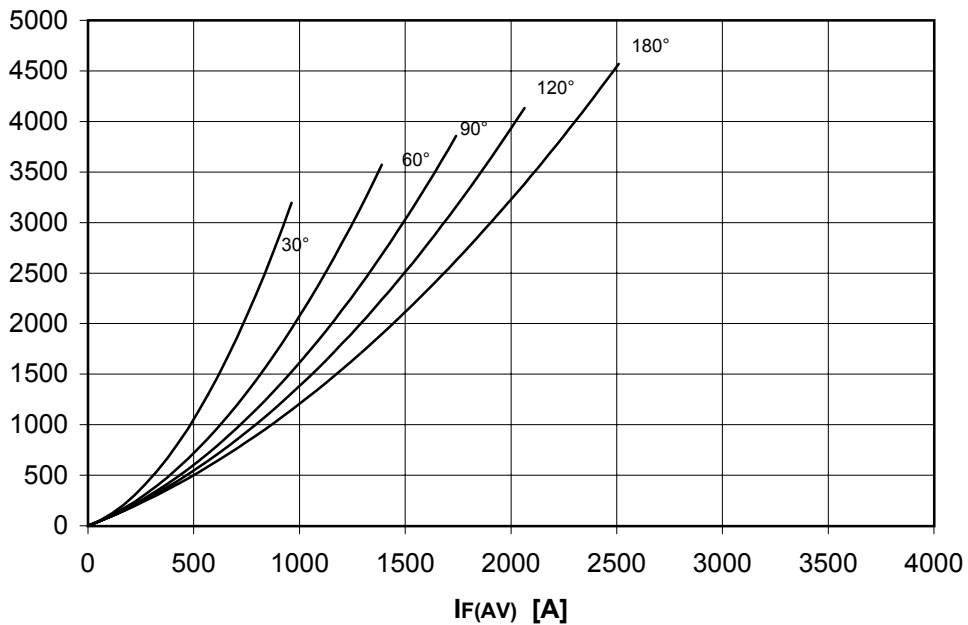

AR2004 RECTIFIER DIODE



FINAL SPECIFICATION nov 02 - ISSUE : 05

FORWARD CHARACTERISTIC
T_j = 175 °C

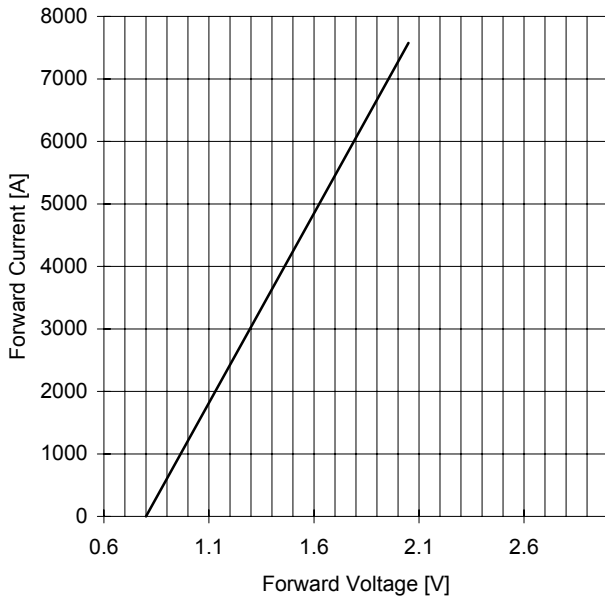

SURGE CHARACTERISTIC
T_j = 175 °C

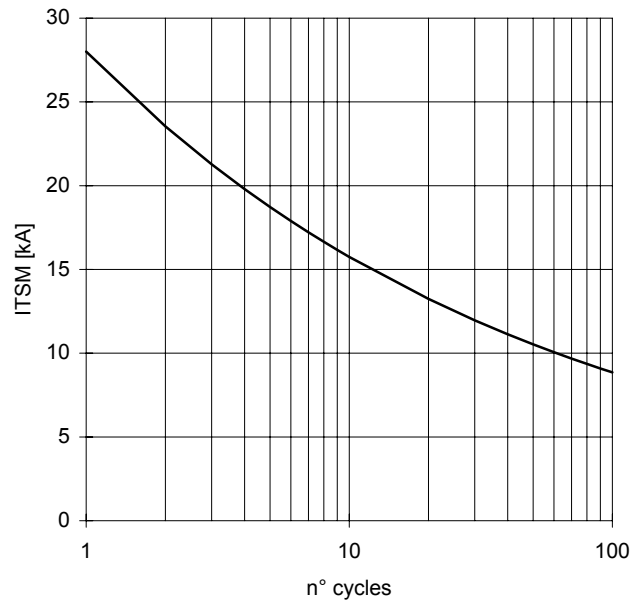

TRANSIENT THERMAL IMPEDANCE
DOUBLE SIDE COOLED

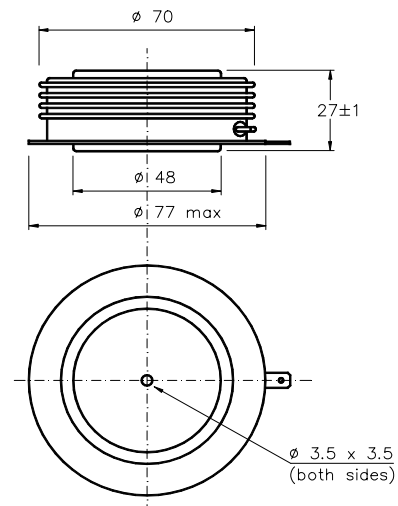
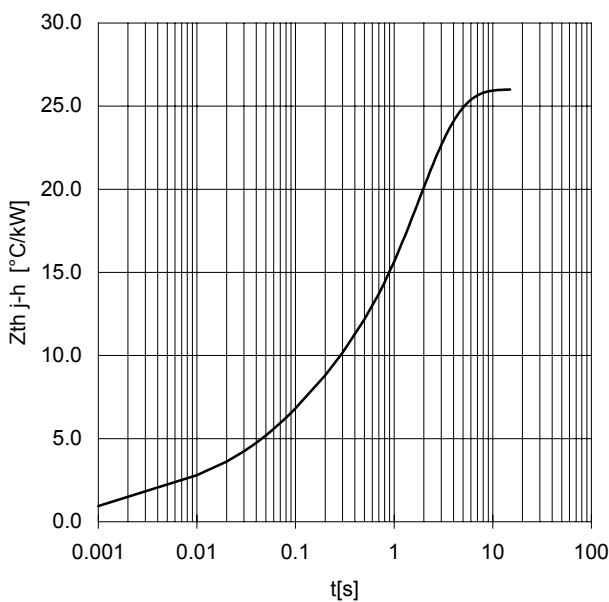

Dimensions
in mm



All the characteristics given in this data sheet are guaranteed only with uniform clamping force, cleaned and lubricated heatsink, surfaces with flatness < .03 mm and roughness < 2 μm.

In the interest of product improvement POSEICO Spa reserves the right to change any data given in this data sheet at any time without previous notice.

If not stated otherwise the maximum value of ratings (symbols over shaded background) and characteristics is reported.

Distributed by

