



Digital Attenuator, 31.5 dB, 6-Bit, TTL Driver, DC - 2.0 GHz

V 4.00

AT20-0107

Features

- Attenuation: 0.5 dB Steps to 31.5 dB¹
- Temperature Stability: ± 0.18 dB from -40°C to $+85^{\circ}\text{C}$ Typ.
- Low DC Power Consumption
- Surface Mount Package
- Integral TTL Driver
- High Intercept Point
- Low Cost/High Performance

Description

M/A-COM's AT20-0107 is a GaAs FET 6-bit digital attenuator with a 0.5 dB minimum step size and a 31.5 dB total attenuation. This attenuator and integral TTL driver is in a ceramic 24-lead surface mount package. The AT20-0107 is ideally suited for use where accuracy, fast speed, very low power consumption and low intermodulation products are required. Typical applications include dynamic range setting in precision receiver circuits and other gain/leveling control circuits. Available with enhanced performance as fully hermetic version. Environmentally screenable as P/N AT-107.

CR-13

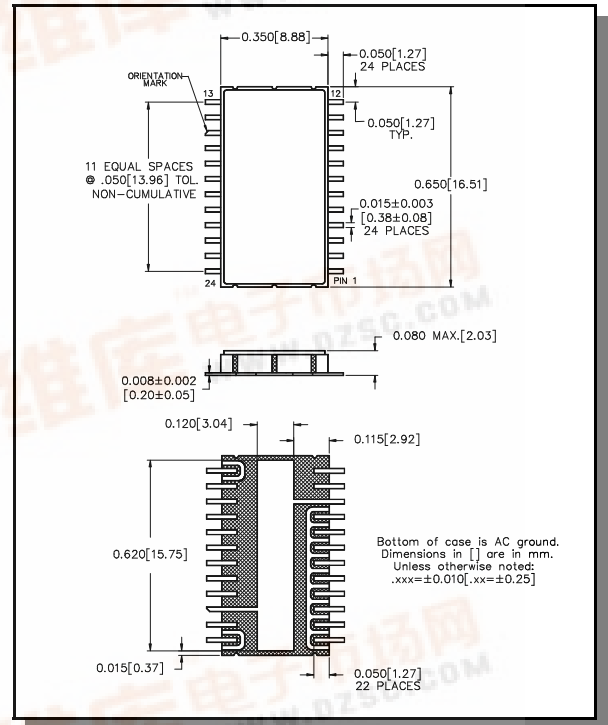

Electrical Specifications²: $T_A = +25^{\circ}\text{C}$

Parameter	Test Conditions	Frequency	Units	Min	Typ.	Max
Insertion Loss	—	DC - 2.0 GHz	dB	—	3.2	3.8
Attenuation Accuracy ^{3,4}	Any Bit or Combination of Bits	DC - 2.0 GHz	dB	—	—	+ (.3 + 7% of atten.) - (.2 + 1% of atten.)
VSWR	Full Range	DC - 2.0 GHz	Ratio	—	—	1.8:1
Trise, Tfall	10% to 90%	—	nS	—	50	—
Ton, Toff	50% Control to 90%/10% RF	—	nS	—	150	—
Transients	In-band (peak to peak)	—	mV	—	50	—
1 dB Compression ⁵	Input Power	50 MHz	dBm	—	+21	—
	Input Power	0.5 - 2.0 GHz	dBm	—	+29	—
Input IP ₃ ⁵	Two Tone Inputs up to +5 dBm	50 MHz	dB	—	+35	—
		0.5 - 2.0 GHz	dB	—	+48	—
Input IP ₂ ⁵	Two Tone Inputs up to +5 dBm	50 MHz	dB	—	+75	—
		0.5 - 2.0 GHz	dB	—	+79	—
Vcc	—	—	V	4.5	5.0	5.5
-Vee	—	—	V	-8.0	—	-5.0
Icc	Vcc = 4.5 to 5.5V	—	mA	—	—	6.0
-Iee	-Vee = -5.0 to -8.0V	—	mA	—	—	1.0

1. Above reference insertion loss.
2. All specifications apply when operated with bias voltages of +5V for V_{CC} and -5.0 V to -8.0 V for V_{EE} and 500 impedance at all ports unless otherwise stated.
3. This attenuator is guaranteed monotonic.
4. For the attenuator to meet the guaranteed specifications, it is necessary to have a DC return on either RF1 or RF2. The DC return can be either a 10KΩ resistor, or an RF choke.
5. V_{EE} = -5 V for the typical numbers given.



Absolute Maximum Ratings ⁶

Parameter	Absolute Maximum
Max. Input Power 0.05 GHz 0.5 - 2.0 GHz	+27 dBm +34 dBm
+Vcc	+5.5V
-Vee	-8.5V
Control Voltage	-0.5V to V _{CC} +0.5V
Operating Temperature	-40°C to +125°C
Storage Temperature	-65°C to +150°C

6. Operation of this device above any one of these parameters may cause permanent damage.

Truth Table

C16	C8	C4	C2	C1	C0.5	Attenuation
0	0	0	0	0	0	Loss, Reference
0	0	0	0	0	1	0.5 dB
0	0	0	0	1	0	1.0 dB
0	0	0	1	0	0	2.0 dB
0	0	1	0	0	0	4.0 dB
0	1	0	0	0	0	8.0 dB
1	0	0	0	0	0	16.0 dB
1	1	1	1	1	1	31.5 dB

0 = TTL Low; 1 = TTL High

Functional Schematic (Top View)

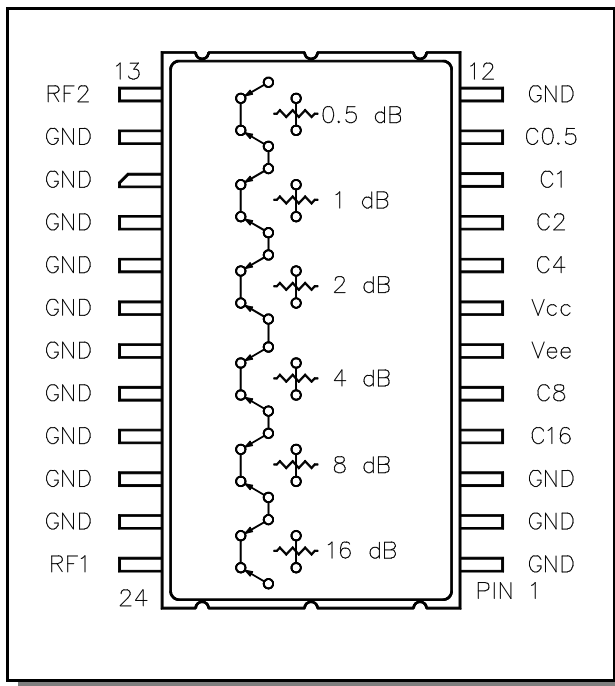

PCB Layout

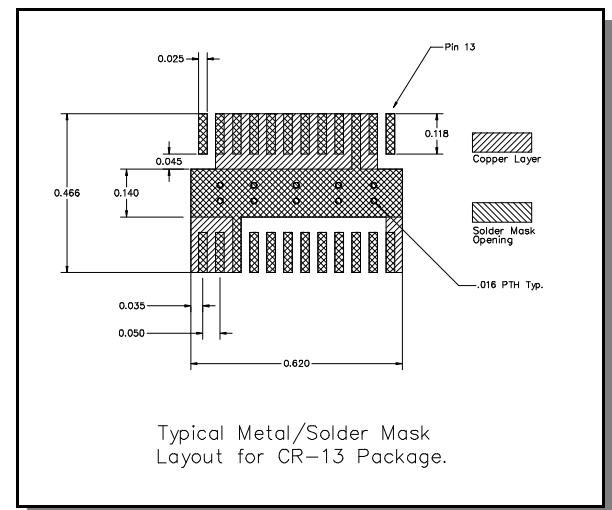

Specifications subject to change without notice.

North America: Tel. (800) 366-2266
Asia/Pacific: Tel.+81-44-844-8296, Fax +81-44-844-8298
Europe: Tel. +44 (1344) 869 595, Fax+44 (1344) 300 020

Typical Performance Curves

Insertion Loss vs. Frequency

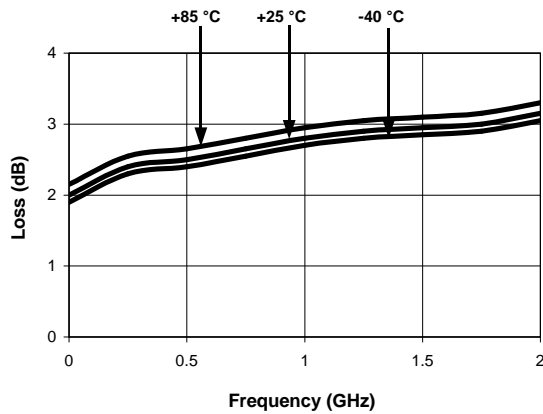

Attenuation Accuracy vs. Frequency

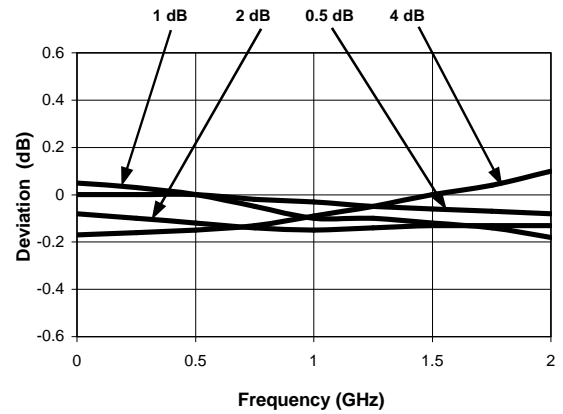

Attenuation Accuracy vs. Frequency

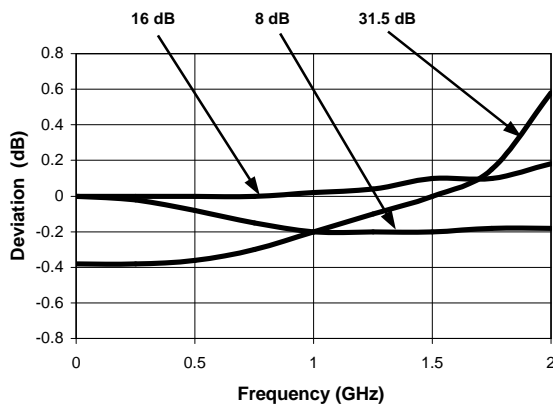

RF1 VSWR vs. Frequency

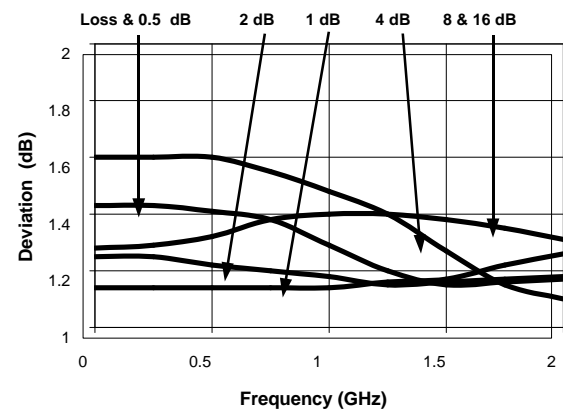

RF2 VSWR vs. Frequency

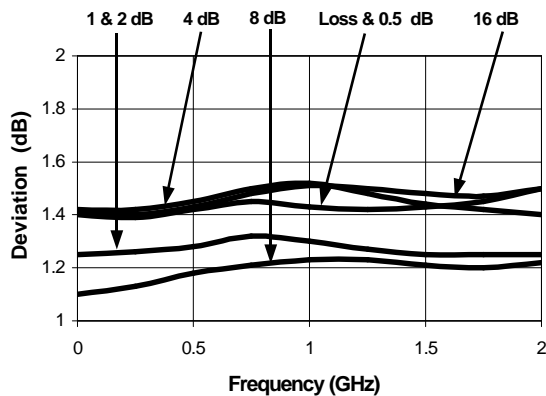

Ordering Information

Part Number	Package
AT20-0107	Bulk Packaging
AT20-0107TR	Tape and Reel (1K Reel)
AT20-0107-TB	Unit mounted on a test board

Specifications subject to change without notice.

■ North America: Tel. (800) 366-2266
 ■ Asia/Pacific: Tel.+81-44-844-8296, Fax +81-44-844-8298
 ■ Europe: Tel. +44 (1344) 869 595, Fax+44 (1344) 300 020