



Low Noise Pseudomorphic HEMT in a Surface Mount Plastic Package

Technical Data

ATF-35143

Features

- Low Noise Figure
- Excellent Uniformity in Product Specifications
- Low Cost Surface Mount Small Plastic Package SOT-343 (4 lead SC-70)
- Tape-and-Reel Packaging Option Available

Specifications

1.9 GHz; 2 V, 15 mA (Typ.)

- 0.4 dB Noise Figure
- 18 dB Associated Gain
- 11 dBm Output Power at 1 dB Gain Compression
- 21 dBm Output 3rd Order Intercept

Applications

- Low Noise Amplifier for Cellular/PCS Handsets
- LNA for WLAN, WLL/RLI, LEO, and MMDS Applications
- General Purpose Discrete PHEMT for Other Ultra Low Noise Applications

Surface Mount Package SOT-343

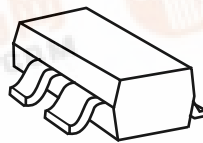

Pin Connections and Package Marking

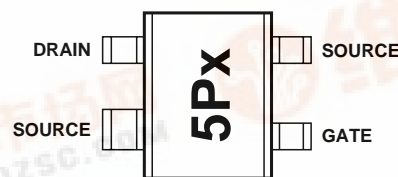

Note: Top View. Package marking provides orientation and identification.
"5P" = Device code
"x" = Date code character. A new character is assigned for each month, year.

Description

Agilent's ATF-35143 is a high dynamic range, low noise, PHEMT housed in a 4-lead SC-70 (SOT-343) surface mount plastic package.

Based on its featured performance, ATF-35143 is suitable for applications in cellular and PCS base stations, LEO systems, MMDS, and other systems requiring super low noise figure with good intercept in the 450 MHz to 10 GHz frequency range.

Other PHEMT devices in this family are the ATF-34143 and the ATF-33143. The typical specifications for these devices at 2 GHz are shown in the table below:

| Part No. | Gate Width | Bias Point | NF (dB) | Ga (dB) | OIP3 (dBm) |
|-----------|------------|------------|---------|---------|------------|
| ATF-33143 | 1600 μ | 4 V, 80 mA | 0.5 | 15.0 | 33.5 |
| ATF-34143 | 800 μ | 4 V, 60 mA | 0.5 | 17.5 | 31.5 |
| ATF-35143 | 400 μ | 2 V, 15 mA | 0.4 | 18.0 | 21.0 |

ATF-35143 Absolute Maximum Ratings^[1]

| Symbol | Parameter | Units | Absolute Maximum |
|---------------|--|-------|--------------------------|
| V_{DS} | Drain - Source Voltage ^[2] | V | 5.5 |
| V_{GS} | Gate - Source Voltage ^[2] | V | -5 |
| V_{GD} | Gate Drain Voltage ^[2] | V | -5 |
| I_{DS} | Drain Current ^[2] | mA | I_{dss} ^[3] |
| P_{diss} | Total Power Dissipation ^[4] | mW | 300 |
| $P_{in\ max}$ | RF Input Power | dBm | 14 |
| T_{CH} | Channel Temperature | °C | 160 |
| T_{STG} | Storage Temperature | °C | -65 to 160 |
| θ_{jc} | Thermal Resistance ^[5] | °C/W | 310 |

Notes:

1. Operation of this device above any one of these parameters may cause permanent damage.
2. Assumes DC quiescent conditions.
3. $V_{GS} = 0\text{ V}$
4. Source lead temperature is 25°C. Derate 3.2 mW/°C for $T_L > 67^\circ\text{C}$.
5. Thermal resistance measured using 150°C Liquid Crystal Measurement method.

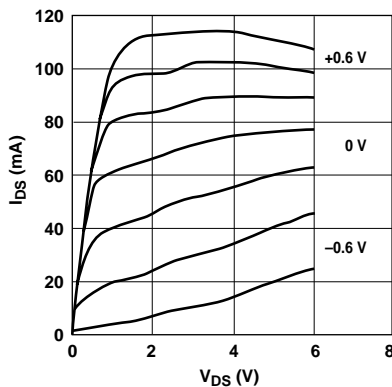

Figure 1. Typical Pulsed I-V Curves^[6].
($V_{GS} = -0.2\text{ V}$ per step)

Product Consistency Distribution Charts^[7, 8]

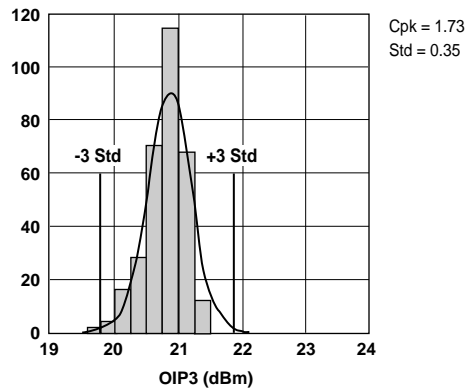

Figure 2. OIP3 @ 2 GHz, 2 V, 15 mA.
LSL=19.0, Nominal=20.9, USL=23.0

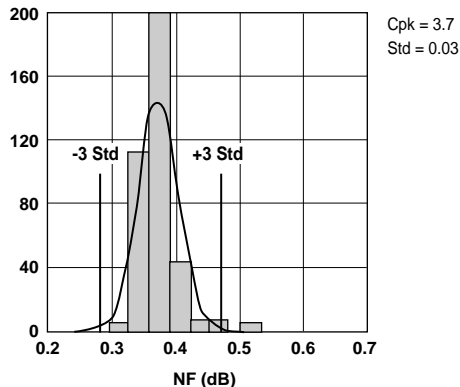

Figure 3. NF @ 2 GHz, 2 V, 15 mA.
LSL=0.2, Nominal=0.37, USL=0.7

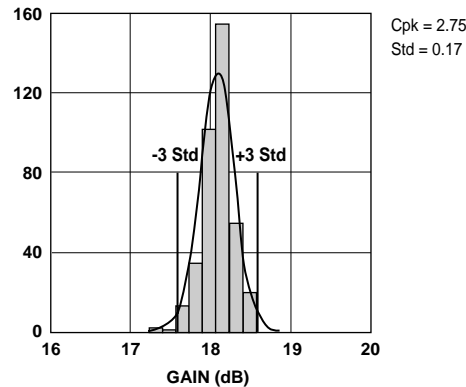

Figure 4. Gain @ 2 GHz, 2 V, 15 mA.
LSL=16.5, Nominal=18.0, USL=19.5

Notes:

6. Under large signal conditions, V_{GS} may swing positive and the drain current may exceed I_{dss} . These conditions are acceptable as long as the maximum P_{diss} and $P_{in\ max}$ ratings are not exceeded.
7. Distribution data sample size is 450 samples taken from 9 different wafers. Future wafers allocated to this product may have nominal values anywhere within the upper and lower spec limits.
8. Measurements made on production test board. This circuit represents a trade-off between an optimal noise match and a realizable match based on production test requirements. Circuit losses have been de-embedded from actual measurements.

ATF-35143 Electrical Specifications

$T_A = 25^\circ\text{C}$, RF parameters measured in a test circuit for a typical device

| Symbol | Parameters and Test Conditions | | Units | Min. | Typ. ^[2] | Max. |
|-----------------|---|---|---------------|------------|---------------------|------------|
| $I_{dss}^{[1]}$ | Saturated Drain Current $V_{DS} = 1.5\text{ V}, V_{GS} = 0\text{ V}$ | | mA | 40 | 65 | 80 |
| $V_P^{[1]}$ | Pinchoff Voltage $V_{DS} = 1.5\text{ V}, I_{DS} = 10\% \text{ of } I_{dss}$ | | V | -0.65 | -0.5 | -0.35 |
| I_d | Quiescent Bias Current $V_{GS} = 0.45\text{ V}, V_{DS} = 2\text{ V}$ | | mA | — | 15 | — |
| $g_m^{[1]}$ | Transconductance $V_{DS} = 1.5\text{ V}, g_m = I_{dss}/V_P$ | | mmho | 90 | 120 | — |
| I_{GD0} | Gate to Drain Leakage Current $V_{GD} = 5\text{ V}$ | | μA | | | 250 |
| I_{gss} | Gate Leakage Current $V_{GD} = V_{GS} = -4\text{ V}$ | | μA | — | 10 | 150 |
| NF | Noise Figure ^[3] | f = 2 GHz $V_{DS} = 2\text{ V}, I_{DS} = 15\text{ mA}$ $V_{DS} = 2\text{ V}, I_{DS} = 5\text{ mA}$ | dB | | 0.4 0.5 | 0.7 0.9 |
| | | f = 900 MHz $V_{DS} = 2\text{ V}, I_{DS} = 15\text{ mA}$ $V_{DS} = 2\text{ V}, I_{DS} = 5\text{ mA}$ | dB | | 0.3 0.4 | |
| G_a | Associated Gain ^[3] | f = 2 GHz $V_{DS} = 2\text{ V}, I_{DS} = 15\text{ mA}$ $V_{DS} = 2\text{ V}, I_{DS} = 5\text{ mA}$ | dB | 16.5 14 | 18 16 | 19.5 18 |
| | | f = 900 MHz $V_{DS} = 2\text{ V}, I_{DS} = 15\text{ mA}$ $V_{DS} = 2\text{ V}, I_{DS} = 5\text{ mA}$ | dB | | 20 18 | |
| OIP3 | Output 3 rd Order Intercept Point ^[4, 5] | f = 2 GHz $V_{DS} = 2\text{ V}, I_{DS} = 15\text{ mA}$ $V_{DS} = 2\text{ V}, I_{DS} = 5\text{ mA}$ | dBm | 19 | 21 14 | |
| | | f = 900 MHz $V_{DS} = 2\text{ V}, I_{DS} = 15\text{ mA}$ $V_{DS} = 2\text{ V}, I_{DS} = 5\text{ mA}$ | dBm | | 19 14 | |
| P_{1dB} | 1 dB Compressed Intercept Point ^[4] | f = 2 GHz $V_{DS} = 2\text{ V}, I_{DSQ} = 15\text{ mA}$ $V_{DS} = 2\text{ V}, I_{DSQ} = 5\text{ mA}$ | dBm | | 10 8 | |
| | | f = 900 MHz $V_{DS} = 2\text{ V}, I_{DSQ} = 15\text{ mA}$ $V_{DS} = 2\text{ V}, I_{DSQ} = 5\text{ mA}$ | dBm | | 9 9 | |

Notes:

1. Guaranteed at wafer probe level
2. Typical value determined from a sample size of 450 parts from 9 wafers.
3. 2V 5 mA min/max data guaranteed via the 2V 15 mA production test.
4. Measurements obtained using production test board described in Figure 5.
5. $P_{out} = -10\text{ dBm}$ per tone

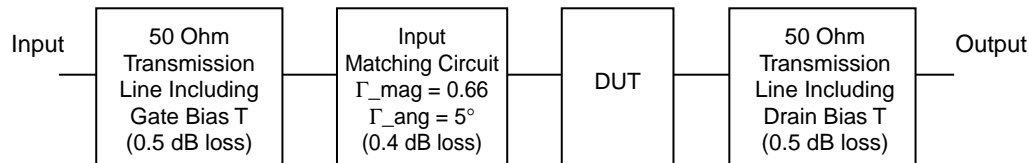

Figure 5. Block diagram of 2 GHz production test board used for Noise Figure, Associated Gain, P_{1dB} , and OIP3 measurements. This circuit represents a trade-off between an optimal noise match and a realizable match based on production test requirements. Circuit losses have been de-embedded from actual measurements.

ATF-35143 Typical Performance Curves

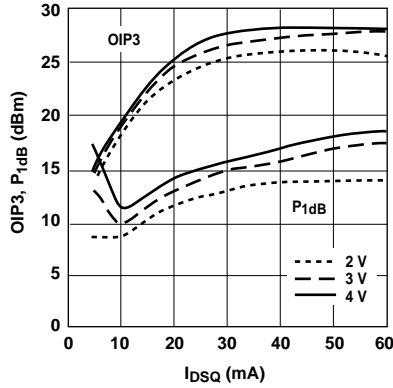

Figure 6. OIP3 and P_{1dB} vs. Bias at 2 GHz.^[1,2]

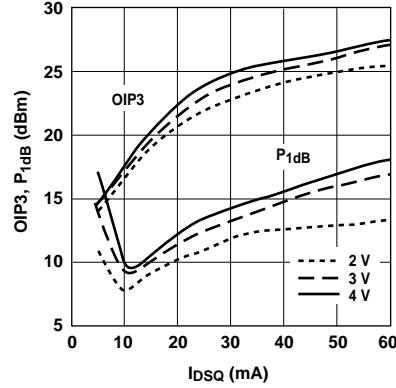

Figure 7. OIP3 and P_{1dB} vs. Bias at 900 MHz.^[1,2]

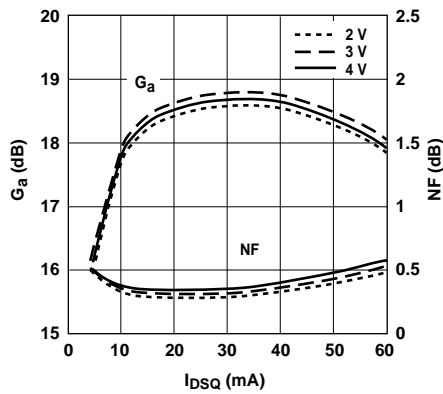

Figure 8. NF and G_a vs. Bias at 2 GHz.^[1]

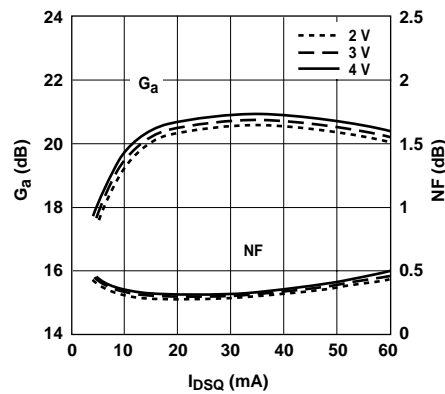

Figure 9. NF and G_a vs. Bias at 900 MHz.^[1]

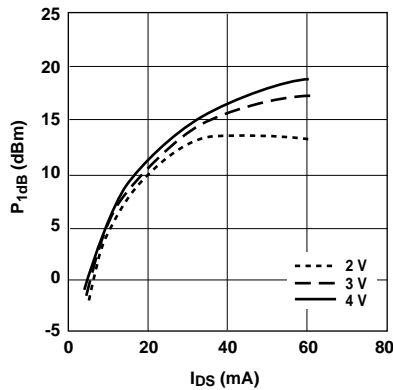

Figure 10. P_{1dB} vs. Bias (Active Bias) Tuned for NF @ 2V, 15 mA at 2 GHz.^[1]

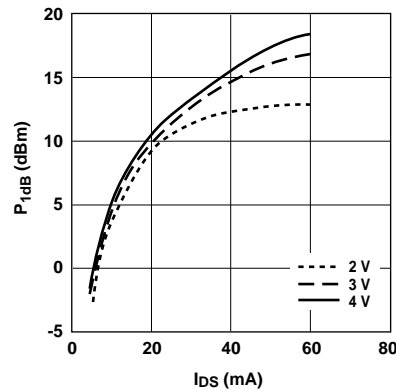

Figure 11. P_{1dB} vs. Bias (Active Bias) Tuned for NF @ 2V, 15 mA at 900 MHz.^[1]

Notes:

- Measurements made on a fixed tuned production test board that was tuned for optimal gain match with reasonable noise figure at 2V 15 mA bias. This circuit represents a trade-off between optimal noise match, maximum gain match and a realizable match based on production test board requirements. Circuit losses have been de-embedded from actual measurements.
- P_{1dB} measurements are performed with passive biasing. Quiescent drain current, I_{DSQ} , is set with zero RF drive applied. As P_{1dB} is approached, the drain current may increase or decrease depending on frequency and dc bias point. At lower values of I_{DSQ} the device is running closer to class B as power output approaches P_{1dB} . This results in higher P_{1dB} and higher PAE (power added efficiency) when compared to a device that is driven by a constant current source as is typically done with active biasing. As an example, at a $V_{DS} = 4V$ and $I_{DSQ} = 5mA$, I_D increases to 30 mA as a P_{1dB} of +15 dBm is approached.

ATF-35143 Typical Performance Curves, continued

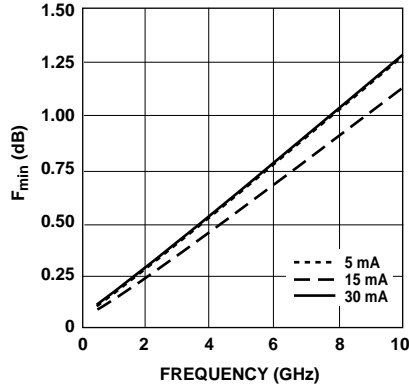

Figure 12. F_{min} vs. Frequency and Current at 2V.

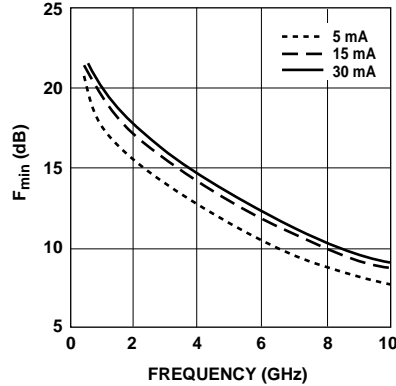

Figure 13. Associated Gain vs. Frequency and Current at 2V.

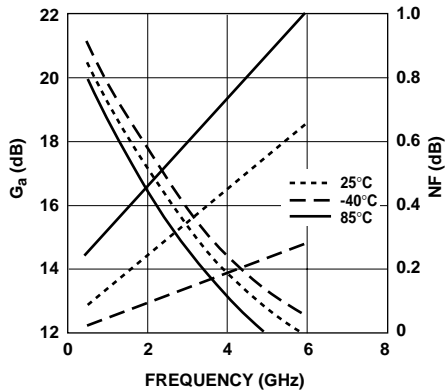

Figure 14. F_{min} and G_a vs. Frequency and Temperature, $V_{DS}=2V$, $I_{DS}=15 mA$.

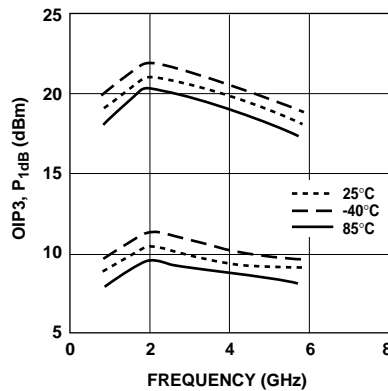

Figure 15. OIP3 and P_{1dB} vs. Frequency and Temperature^[1,2], $V_{DS}=2V$, $I_{DS}=15 mA$.

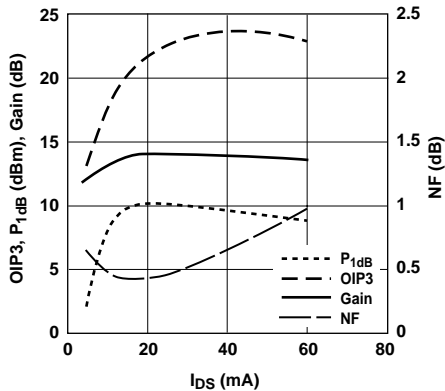

Figure 16. OIP3, P_{1dB} , NF and Gain vs. Bias^[1] (Active Bias, 2V, 3.9 GHz).

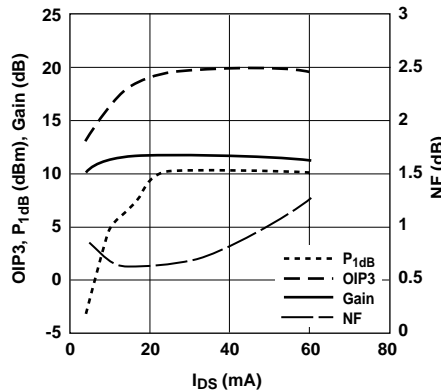

Figure 17. OIP3, P_{1dB} , NF and Gain vs. Bias^[1] (Active Bias, 2V, 5.8 GHz).

Notes:

1. Measurements made on a fixed tuned test fixture that was tuned for noise figure at 2V 15mA bias. This circuit represents a trade-off between optimal noise match, maximum gain match and a realizable match based on production test requirements. Circuit losses have been de-embedded from actual measurements.

2. P_{1dB} measurements are performed with passive biasing. Quiescent drain current, I_{DSQ} , is set with zero RF drive applied. As P_{1dB} is approached, the drain current may increase or decrease depending on frequency and dc bias point. At lower values of I_{DSQ} the device is running closer to class B as power output approaches P_{1dB} . This results in higher P_{1dB} and higher PAE (power added efficiency) when compared to a device that is driven by a constant current source as is typically done with active biasing. As an example, at a $V_{DC} = 4V$

ATF-35143 Typical Scattering Parameters, $V_{DS} = 2\text{ V}$, $I_{DS} = 5\text{ mA}$

| Freq. GHz | S_{11} | | S_{21} | | | S_{12} | | | S_{22} | | MSG/MAG dB |
|--------------|----------|---------|----------|------|---------|----------|-------|---------|----------|---------|---------------|
| | Mag. | Ang. | dB | Mag. | Ang. | dB | Mag. | Ang. | Mag. | Ang. | |
| 0.50 | 0.99 | -16.90 | 13.34 | 4.64 | 166.04 | -31.70 | 0.026 | 77.91 | 0.73 | -12.47 | 22.52 |
| 0.75 | 0.98 | -26.37 | 13.29 | 4.62 | 157.78 | -28.18 | 0.039 | 71.12 | 0.72 | -17.53 | 20.83 |
| 1.00 | 0.97 | -34.76 | 13.16 | 4.55 | 150.72 | -25.85 | 0.051 | 65.76 | 0.71 | -23.33 | 19.50 |
| 1.50 | 0.94 | -50.59 | 12.83 | 4.38 | 137.02 | -22.73 | 0.073 | 54.85 | 0.68 | -34.88 | 17.78 |
| 1.75 | 0.91 | -58.26 | 12.66 | 4.30 | 130.38 | -21.62 | 0.083 | 49.69 | 0.67 | -40.49 | 17.13 |
| 2.00 | 0.90 | -65.74 | 12.44 | 4.19 | 123.90 | -20.72 | 0.092 | 44.45 | 0.65 | -46.03 | 16.58 |
| 2.50 | 0.85 | -80.62 | 12.04 | 4.00 | 111.27 | -19.33 | 0.108 | 34.61 | 0.62 | -56.68 | 15.69 |
| 3.00 | 0.81 | -95.48 | 11.61 | 3.81 | 99.08 | -18.27 | 0.122 | 25.21 | 0.59 | -66.71 | 14.94 |
| 4.00 | 0.72 | -125.99 | 10.71 | 3.43 | 75.75 | -17.08 | 0.140 | 6.95 | 0.52 | -85.11 | 13.89 |
| 5.00 | 0.66 | -156.09 | 9.79 | 3.09 | 53.63 | -16.48 | 0.150 | -9.83 | 0.45 | -102.71 | 13.13 |
| 6.00 | 0.62 | 174.97 | 8.93 | 2.80 | 32.77 | -16.14 | 0.156 | -25.73 | 0.38 | -120.16 | 12.53 |
| 7.00 | 0.60 | 145.61 | 8.06 | 2.53 | 12.43 | -16.08 | 0.157 | -41.00 | 0.31 | -138.01 | 12.07 |
| 8.00 | 0.60 | 118.39 | 7.20 | 2.29 | -7.12 | -16.31 | 0.153 | -54.14 | 0.25 | -157.10 | 11.75 |
| 9.00 | 0.62 | 93.15 | 6.26 | 2.06 | -26.14 | -16.59 | 0.148 | -67.05 | 0.20 | -178.27 | 11.19 |
| 10.00 | 0.66 | 71.31 | 5.43 | 1.87 | -44.14 | -16.89 | 0.143 | -78.09 | 0.16 | 157.62 | 9.63 |
| 11.00 | 0.70 | 50.91 | 4.58 | 1.69 | -62.85 | -17.14 | 0.139 | -88.99 | 0.14 | 121.82 | 8.81 |
| 12.00 | 0.72 | 31.04 | 3.64 | 1.52 | -81.42 | -17.52 | 0.133 | -100.38 | 0.17 | 82.33 | 7.87 |
| 13.00 | 0.74 | 11.26 | 2.56 | 1.34 | -99.46 | -18.13 | 0.124 | -111.06 | 0.22 | 53.17 | 6.79 |
| 14.00 | 0.76 | -3.08 | 1.45 | 1.18 | -115.94 | -18.79 | 0.115 | -119.00 | 0.28 | 27.32 | 5.86 |
| 15.00 | 0.82 | -14.26 | 0.43 | 1.05 | -132.24 | -19.25 | 0.109 | -127.12 | 0.34 | 6.01 | 5.89 |
| 16.00 | 0.82 | -26.64 | -0.72 | 0.92 | -149.24 | -19.58 | 0.105 | -135.42 | 0.42 | -10.69 | 4.84 |
| 17.00 | 0.84 | -38.94 | -1.83 | 0.81 | -164.44 | -19.74 | 0.103 | -143.49 | 0.49 | -22.32 | 4.62 |
| 18.00 | 0.86 | -54.78 | -3.02 | 0.71 | 179.28 | -20.18 | 0.098 | -152.36 | 0.56 | -35.90 | 4.04 |

ATF-35143 Typical Noise Parameters
 $V_{DS} = 2\text{ V}$, $I_{DS} = 5\text{ mA}$

| Freq. GHz | F_{min} dB | Γ_{opt} | | $R_{n/50}$ - | G_a dB |
|--------------|-----------------|----------------|--------|-----------------|-------------|
| | | Mag. | Ang. | | |
| 0.5 | 0.10 | 0.91 | 6.4 | 0.22 | 19.3 |
| 0.9 | 0.12 | 0.87 | 15.0 | 0.22 | 17.9 |
| 1.0 | 0.14 | 0.86 | 17.2 | 0.22 | 17.5 |
| 1.5 | 0.20 | 0.81 | 28.0 | 0.22 | 16.3 |
| 1.8 | 0.23 | 0.78 | 33.4 | 0.21 | 15.8 |
| 2.0 | 0.27 | 0.76 | 38.8 | 0.21 | 15.4 |
| 2.5 | 0.33 | 0.71 | 50.0 | 0.19 | 14.7 |
| 3.0 | 0.39 | 0.66 | 61.9 | 0.17 | 14.0 |
| 4.0 | 0.52 | 0.58 | 87.2 | 0.13 | 12.7 |
| 5.0 | 0.64 | 0.52 | 114.4 | 0.09 | 11.5 |
| 6.0 | 0.77 | 0.47 | 143.2 | 0.06 | 10.4 |
| 7.0 | 0.89 | 0.43 | 173.5 | 0.05 | 9.5 |
| 8.0 | 1.02 | 0.41 | -155.2 | 0.07 | 8.7 |
| 9.0 | 1.14 | 0.40 | -122.9 | 0.13 | 8.0 |
| 10.0 | 1.27 | 0.41 | -90.1 | 0.24 | 7.5 |

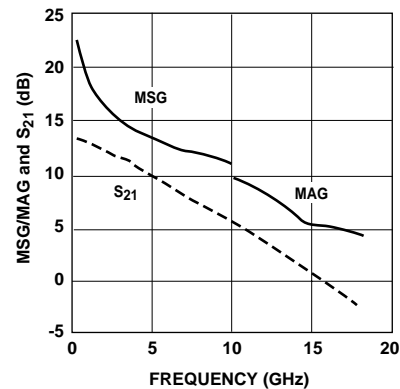

Figure 18. MSG/MAG and $|S_{21}|^2$ vs. Frequency at 2 V, 5 mA.

Notes:

- F_{min} values at 2 GHz and higher are based on measurements while the F_{min} s below 2 GHz have been extrapolated. The F_{min} values are based on a set of 16 noise figure measurements made at 16 different impedances using an ATN NP5 test system. From these measurements a true F_{min} is calculated. Refer to the noise parameter application section for more information.
- S and noise parameters are measured on a microstrip line made on 0.025 inch thick alumina carrier. The input reference plane is at the end of the gate lead. The output reference plane is at the end of the drain lead. The parameters include the effect of four plated through via holes connecting source landing pads on top of the test carrier to the microstrip ground plane on the bottom side of the carrier. Two 0.020 inch diameter via holes are placed within 0.010 inch from each source lead contact point, one via on each side of that point.

ATF-35143 Typical Scattering Parameters, $V_{DS} = 2\text{ V}$, $I_{DS} = 10\text{ mA}$

| Freq. GHz | S_{11} | | S_{21} | | | S_{12} | | | S_{22} | | MSG/MAG dB |
|--------------|----------|---------|----------|------|---------|----------|-------|---------|----------|---------|---------------|
| | Mag. | Ang. | dB | Mag. | Ang. | dB | Mag. | Ang. | Mag. | Ang. | |
| 0.50 | 0.99 | -18.75 | 15.89 | 6.23 | 164.76 | -32.40 | 0.024 | 77.63 | 0.63 | -14.09 | 24.14 |
| 0.75 | 0.97 | -29.11 | 15.79 | 6.16 | 155.98 | -28.87 | 0.036 | 70.58 | 0.61 | -19.69 | 22.30 |
| 1.00 | 0.95 | -38.28 | 15.61 | 6.03 | 148.42 | -26.56 | 0.047 | 64.88 | 0.60 | -26.10 | 21.08 |
| 1.50 | 0.91 | -55.52 | 15.17 | 5.73 | 133.92 | -23.61 | 0.066 | 54.16 | 0.57 | -38.73 | 19.39 |
| 1.75 | 0.89 | -63.78 | 14.92 | 5.57 | 127.01 | -22.62 | 0.074 | 49.11 | 0.56 | -44.79 | 18.75 |
| 2.00 | 0.86 | -71.82 | 14.65 | 5.40 | 120.27 | -21.72 | 0.082 | 44.08 | 0.54 | -50.70 | 18.19 |
| 2.50 | 0.81 | -87.59 | 14.11 | 5.08 | 107.36 | -20.35 | 0.096 | 34.60 | 0.51 | -61.95 | 17.23 |
| 3.00 | 0.76 | -103.22 | 13.54 | 4.76 | 95.04 | -19.41 | 0.107 | 25.71 | 0.47 | -72.47 | 16.48 |
| 4.00 | 0.66 | -134.81 | 12.40 | 4.17 | 71.95 | -18.27 | 0.122 | 9.04 | 0.41 | -91.47 | 15.34 |
| 5.00 | 0.61 | -165.34 | 11.29 | 3.67 | 50.43 | -17.65 | 0.131 | -5.97 | 0.34 | -110.05 | 14.47 |
| 6.00 | 0.58 | 165.88 | 10.27 | 3.26 | 30.28 | -17.33 | 0.136 | -20.15 | 0.27 | -129.24 | 13.80 |
| 7.00 | 0.57 | 137.00 | 9.27 | 2.91 | 10.68 | -17.14 | 0.139 | -33.84 | 0.21 | -150.49 | 13.21 |
| 8.00 | 0.58 | 110.78 | 8.33 | 2.61 | -8.09 | -17.14 | 0.139 | -45.60 | 0.17 | -174.77 | 12.73 |
| 9.00 | 0.61 | 86.75 | 7.32 | 2.32 | -26.38 | -17.20 | 0.138 | -57.65 | 0.13 | 154.01 | 10.69 |
| 10.00 | 0.65 | 66.25 | 6.44 | 2.10 | -43.90 | -17.20 | 0.138 | -68.22 | 0.11 | 118.18 | 9.85 |
| 11.00 | 0.69 | 46.88 | 5.54 | 1.89 | -61.97 | -17.27 | 0.137 | -79.30 | 0.14 | 78.36 | 9.16 |
| 12.00 | 0.72 | 27.76 | 4.56 | 1.69 | -79.90 | -17.39 | 0.135 | -90.87 | 0.19 | 49.57 | 8.34 |
| 13.00 | 0.74 | 8.62 | 3.45 | 1.49 | -97.18 | -17.79 | 0.129 | -102.19 | 0.26 | 29.95 | 7.35 |
| 14.00 | 0.77 | -5.28 | 2.33 | 1.31 | -112.92 | -18.20 | 0.123 | -110.80 | 0.33 | 9.45 | 6.51 |
| 15.00 | 0.82 | -16.03 | 1.29 | 1.16 | -128.66 | -18.56 | 0.118 | -120.09 | 0.39 | -7.98 | 6.51 |
| 16.00 | 0.82 | -28.32 | 0.19 | 1.02 | -144.87 | -18.79 | 0.115 | -129.92 | 0.45 | -22.30 | 5.48 |
| 17.00 | 0.84 | -40.43 | -0.87 | 0.91 | -159.49 | -18.79 | 0.115 | -139.60 | 0.51 | -32.23 | 5.24 |
| 18.00 | 0.86 | -56.14 | -1.99 | 0.80 | -175.19 | -19.33 | 0.108 | -149.17 | 0.57 | -44.43 | 4.72 |

ATF-35143 Typical Noise Parameters
 $V_{DS} = 2\text{ V}$, $I_{DS} = 10\text{ mA}$

| Freq. GHz | F_{min} dB | Γ_{opt} | | $R_{n/50}$ - | G_a dB |
|--------------|-----------------|----------------|--------|-----------------|-------------|
| | | Mag. | Ang. | | |
| 0.5 | 0.10 | 0.88 | 5.0 | 0.15 | 20.5 |
| 0.9 | 0.11 | 0.84 | 14.0 | 0.15 | 19.0 |
| 1.0 | 0.12 | 0.83 | 16.0 | 0.15 | 18.6 |
| 1.5 | 0.17 | 0.77 | 26.0 | 0.15 | 17.5 |
| 1.8 | 0.20 | 0.74 | 31.9 | 0.15 | 16.9 |
| 2.0 | 0.23 | 0.71 | 37.3 | 0.14 | 16.4 |
| 2.5 | 0.29 | 0.66 | 48.6 | 0.14 | 15.7 |
| 3.0 | 0.34 | 0.60 | 60.6 | 0.12 | 15.0 |
| 4.0 | 0.46 | 0.52 | 86.8 | 0.12 | 13.6 |
| 5.0 | 0.58 | 0.45 | 115.3 | 0.08 | 12.4 |
| 6.0 | 0.69 | 0.40 | 145.8 | 0.05 | 11.3 |
| 7.0 | 0.81 | 0.37 | 177.7 | 0.05 | 10.3 |
| 8.0 | 0.92 | 0.35 | -149.3 | 0.07 | 9.5 |
| 9.0 | 1.04 | 0.35 | -115.6 | 0.12 | 8.8 |
| 10.0 | 1.16 | 0.37 | -81.8 | 0.22 | 8.3 |

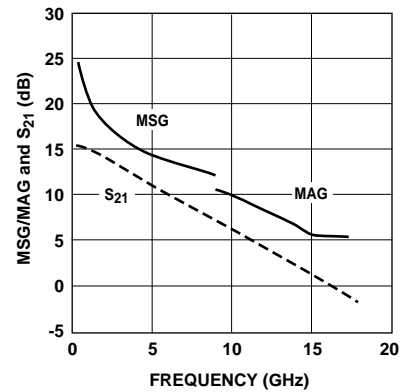

Figure 19. MSG/MAG and $|S_{21}|^2$ vs. Frequency at 2 V, 10 mA.

Notes:

- F_{min} values at 2 GHz and higher are based on measurements while the F_{min} s below 2 GHz have been extrapolated. The F_{min} values are based on a set of 16 noise figure measurements made at sixteen different impedances using an ATN NP5 test system. From these measurements a true F_{min} is calculated. Refer to the noise parameter application section for more information.
- S and noise parameters are measured on a microstrip line made on 0.025 inch thick alumina carrier. The input reference plane is at the end of the gate lead. The output reference plane is at the end of the drain lead. The parameters include the effect of four plated through via holes connecting source landing pads on top of the test carrier to the microstrip ground plane on the bottom side of the carrier. Two 0.020 inch diameter via holes are placed within 0.010 inch from each source lead contact point, one via on each side of that point.

ATF-35143 Typical Scattering Parameters, $V_{DS} = 2\text{ V}$, $I_{DS} = 15\text{ mA}$

| Freq. GHz | S_{11} | | S_{21} | | | S_{12} | | | S_{22} | | MSG/MAG dB |
|--------------|----------|---------|----------|------|---------|----------|-------|---------|----------|---------|---------------|
| | Mag. | Ang. | dB | Mag. | Ang. | dB | Mag. | Ang. | Mag. | Ang. | |
| 0.50 | 0.99 | -19.75 | 17.02 | 7.10 | 164.04 | -32.77 | 0.023 | 77.60 | 0.57 | -14.99 | 24.89 |
| 0.75 | 0.97 | -30.58 | 16.90 | 7.00 | 154.98 | -29.37 | 0.034 | 70.54 | 0.55 | -20.86 | 23.05 |
| 1.00 | 0.95 | -40.15 | 16.69 | 6.83 | 147.18 | -27.13 | 0.044 | 64.80 | 0.54 | -27.61 | 21.91 |
| 1.50 | 0.90 | -58.08 | 16.18 | 6.44 | 132.28 | -24.15 | 0.062 | 54.23 | 0.51 | -40.74 | 20.17 |
| 1.75 | 0.87 | -66.65 | 15.90 | 6.23 | 125.22 | -23.10 | 0.070 | 49.25 | 0.49 | -46.95 | 19.53 |
| 2.00 | 0.84 | -74.93 | 15.59 | 6.02 | 118.41 | -22.27 | 0.077 | 44.36 | 0.48 | -53.06 | 18.93 |
| 2.50 | 0.79 | -91.13 | 14.97 | 5.61 | 105.38 | -20.92 | 0.090 | 35.36 | 0.44 | -64.59 | 17.95 |
| 3.00 | 0.73 | -107.08 | 14.34 | 5.21 | 93.08 | -20.00 | 0.100 | 26.85 | 0.41 | -75.32 | 17.17 |
| 4.00 | 0.64 | -139.07 | 13.09 | 4.51 | 70.17 | -18.94 | 0.113 | 11.15 | 0.35 | -94.59 | 16.01 |
| 5.00 | 0.59 | -169.70 | 11.90 | 3.93 | 49.03 | -18.27 | 0.122 | -2.96 | 0.29 | -113.89 | 15.09 |
| 6.00 | 0.56 | 161.74 | 10.81 | 3.47 | 29.27 | -17.79 | 0.129 | -16.43 | 0.23 | -134.46 | 14.30 |
| 7.00 | 0.56 | 133.19 | 9.77 | 3.08 | 10.04 | -17.59 | 0.132 | -29.47 | 0.17 | -158.65 | 13.68 |
| 8.00 | 0.57 | 107.56 | 8.78 | 2.75 | -8.35 | -17.46 | 0.134 | -40.80 | 0.14 | 172.14 | 12.29 |
| 9.00 | 0.60 | 84.16 | 7.75 | 2.44 | -26.29 | -17.39 | 0.135 | -52.63 | 0.11 | 134.01 | 10.74 |
| 10.00 | 0.64 | 64.19 | 6.86 | 2.20 | -43.56 | -17.33 | 0.136 | -63.33 | 0.12 | 95.85 | 9.99 |
| 11.00 | 0.68 | 45.46 | 5.93 | 1.98 | -61.33 | -17.27 | 0.137 | -74.77 | 0.16 | 63.20 | 9.34 |
| 12.00 | 0.72 | 26.66 | 4.93 | 1.76 | -78.94 | -17.27 | 0.137 | -86.46 | 0.22 | 40.01 | 8.57 |
| 13.00 | 0.74 | 7.70 | 3.80 | 1.55 | -95.93 | -17.59 | 0.132 | -98.11 | 0.29 | 23.11 | 7.62 |
| 14.00 | 0.77 | -5.93 | 2.68 | 1.36 | -111.53 | -17.92 | 0.127 | -107.51 | 0.36 | 3.55 | 6.79 |
| 15.00 | 0.82 | -16.54 | 1.63 | 1.21 | -126.76 | -18.20 | 0.123 | -117.16 | 0.41 | -12.09 | 6.76 |
| 16.00 | 0.82 | -28.76 | 0.54 | 1.06 | -142.70 | -18.49 | 0.119 | -127.03 | 0.47 | -26.21 | 5.81 |
| 17.00 | 0.84 | -40.79 | -0.49 | 0.95 | -157.02 | -18.49 | 0.119 | -137.06 | 0.53 | -35.57 | 5.55 |
| 18.00 | 0.86 | -56.40 | -1.60 | 0.83 | -172.47 | -18.94 | 0.113 | -147.50 | 0.58 | -47.29 | 5.06 |

ATF-35143 Typical Noise Parameters
 $V_{DS} = 2\text{ V}$, $I_{DS} = 15\text{ mA}$

| Freq. GHz | F_{min} dB | Γ_{opt} | | $R_{n/50}$ - | G_a dB |
|--------------|-----------------|----------------|--------|-----------------|-------------|
| | | Mag. | Ang. | | |
| 0.5 | 0.10 | 0.88 | 4.5 | 0.19 | 20.9 |
| 0.9 | 0.13 | 0.83 | 13.1 | 0.17 | 19.4 |
| 1.0 | 0.14 | 0.82 | 15.3 | 0.16 | 19.2 |
| 1.5 | 0.19 | 0.76 | 26.1 | 0.15 | 17.9 |
| 1.8 | 0.22 | 0.72 | 32.6 | 0.15 | 17.3 |
| 2.0 | 0.23 | 0.70 | 36.9 | 0.14 | 17.0 |
| 2.5 | 0.29 | 0.64 | 48.5 | 0.12 | 16.2 |
| 3.0 | 0.34 | 0.58 | 60.9 | 0.07 | 15.4 |
| 4.0 | 0.45 | 0.49 | 87.9 | 0.13 | 14.1 |
| 5.0 | 0.56 | 0.42 | 117.4 | 0.07 | 12.8 |
| 6.0 | 0.67 | 0.37 | 149.0 | 0.05 | 11.7 |
| 7.0 | 0.79 | 0.34 | -178.1 | 0.05 | 10.8 |
| 8.0 | 0.90 | 0.33 | -144.3 | 0.07 | 9.9 |
| 9.0 | 1.01 | 0.34 | -110.2 | 0.13 | 9.2 |
| 10.0 | 1.12 | 0.36 | -76.3 | 0.23 | 8.6 |

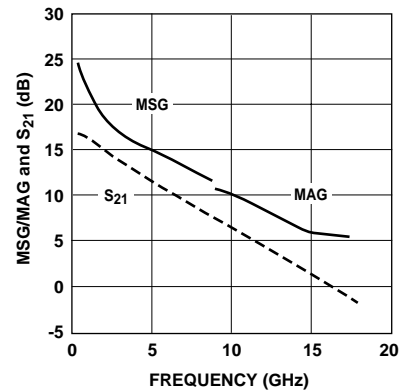

Figure 20. MSG/MAG and $|S_{21}|^2$ vs. Frequency at 2 V, 15 mA.

Notes:

- F_{min} values at 2 GHz and higher are based on measurements while the F_{min} values below 2 GHz have been extrapolated. The F_{min} values are based on a set of 16 noise figure measurements made at 16 different impedances using an ATF NP5 test system. From these measurements a true F_{min} is calculated. Refer to the noise parameter application section for more information.
- S and noise parameters are measured on a microstrip line made on 0.025 inch thick alumina carrier. The input reference plane is at the end of the gate lead. The output reference plane is at the end of the drain lead. The parameters include the effect of four plated through via holes connecting source landing pads on top of the test carrier to the microstrip ground plane on the bottom side of the carrier. Two 0.020 inch diameter via holes are placed within 0.010 inch from each source lead contact point, one via on each side of that point.

ATF-35143 Typical Scattering Parameters, $V_{DS} = 2\text{ V}$, $I_{DS} = 30\text{ mA}$

| Freq. GHz | S_{11} | | S_{21} | | | S_{12} | | | S_{22} | | MSG/MAG dB |
|--------------|----------|---------|----------|------|---------|----------|-------|---------|----------|---------|---------------|
| | Mag. | Ang. | dB | Mag. | Ang. | dB | Mag. | Ang. | Mag. | Ang. | |
| 0.50 | 0.99 | -20.95 | 18.17 | 8.10 | 163.18 | -33.56 | 0.021 | 77.39 | 0.49 | -15.99 | 25.87 |
| 0.75 | 0.96 | -32.34 | 18.02 | 7.96 | 153.79 | -30.17 | 0.031 | 70.55 | 0.47 | -22.00 | 24.10 |
| 1.00 | 0.94 | -42.36 | 17.77 | 7.73 | 145.67 | -27.96 | 0.040 | 65.08 | 0.46 | -29.03 | 22.86 |
| 1.50 | 0.88 | -61.09 | 17.18 | 7.22 | 130.36 | -25.04 | 0.056 | 54.79 | 0.43 | -42.64 | 21.11 |
| 1.75 | 0.85 | -69.98 | 16.85 | 6.96 | 123.20 | -24.01 | 0.063 | 50.12 | 0.41 | -48.96 | 20.42 |
| 2.00 | 0.82 | -78.53 | 16.50 | 6.69 | 116.28 | -23.22 | 0.069 | 45.58 | 0.39 | -55.19 | 19.86 |
| 2.50 | 0.76 | -95.14 | 15.81 | 6.17 | 103.17 | -21.94 | 0.080 | 37.15 | 0.36 | -66.91 | 18.87 |
| 3.00 | 0.70 | -111.48 | 15.11 | 5.69 | 90.88 | -21.01 | 0.089 | 29.29 | 0.34 | -77.74 | 18.06 |
| 4.00 | 0.61 | -143.89 | 13.73 | 4.86 | 68.24 | -19.83 | 0.102 | 14.76 | 0.28 | -97.29 | 16.78 |
| 5.00 | 0.56 | -174.55 | 12.46 | 4.20 | 47.48 | -19.02 | 0.112 | 1.63 | 0.23 | -117.24 | 15.74 |
| 6.00 | 0.55 | 157.19 | 11.31 | 3.68 | 28.10 | -18.49 | 0.119 | -10.98 | 0.17 | -139.78 | 14.90 |
| 7.00 | 0.55 | 129.18 | 10.22 | 3.24 | 9.28 | -18.13 | 0.124 | -23.67 | 0.13 | -169.09 | 14.17 |
| 8.00 | 0.56 | 104.19 | 9.20 | 2.88 | -8.75 | -17.79 | 0.129 | -34.72 | 0.11 | 155.22 | 11.98 |
| 9.00 | 0.60 | 81.48 | 8.15 | 2.56 | -26.37 | -17.59 | 0.132 | -46.33 | 0.11 | 112.23 | 10.82 |
| 10.00 | 0.64 | 62.07 | 7.24 | 2.30 | -43.37 | -17.33 | 0.136 | -57.43 | 0.13 | 77.30 | 10.15 |
| 11.00 | 0.68 | 43.83 | 6.29 | 2.06 | -60.90 | -17.20 | 0.138 | -68.78 | 0.18 | 51.74 | 9.51 |
| 12.00 | 0.72 | 25.46 | 5.27 | 1.84 | -78.22 | -17.14 | 0.139 | -81.32 | 0.24 | 32.67 | 8.77 |
| 13.00 | 0.74 | 6.81 | 4.14 | 1.61 | -94.88 | -17.33 | 0.136 | -93.11 | 0.31 | 17.81 | 7.87 |
| 14.00 | 0.77 | -6.74 | 3.01 | 1.41 | -110.07 | -17.65 | 0.131 | -103.06 | 0.38 | 0.45 | 7.08 |
| 15.00 | 0.82 | -17.21 | 1.94 | 1.25 | -125.15 | -17.86 | 0.128 | -112.88 | 0.43 | -15.44 | 7.06 |
| 16.00 | 0.83 | -29.31 | 0.87 | 1.11 | -140.80 | -18.06 | 0.125 | -123.55 | 0.49 | -29.37 | 6.13 |
| 17.00 | 0.85 | -41.30 | -0.15 | 0.98 | -154.83 | -18.13 | 0.124 | -134.43 | 0.54 | -38.55 | 5.89 |
| 18.00 | 0.87 | -56.87 | -1.24 | 0.87 | -170.03 | -18.56 | 0.118 | -144.88 | 0.60 | -49.70 | 5.39 |

ATF-35143 Typical Noise Parameters
 $V_{DS} = 2\text{ V}$, $I_{DS} = 30\text{ mA}$

| Freq. GHz | F_{\min} dB | Γ_{opt} | | $R_{n/50}$ - | G_a dB |
|--------------|------------------|-----------------------|--------|-----------------|-------------|
| | | Mag. | Ang. | | |
| 0.5 | 0.11 | 0.87 | 2.7 | 0.18 | 21.6 |
| 0.9 | 0.15 | 0.81 | 12.1 | 0.17 | 20.2 |
| 1.0 | 0.16 | 0.80 | 14.5 | 0.16 | 19.9 |
| 1.5 | 0.22 | 0.73 | 26.3 | 0.15 | 18.7 |
| 1.8 | 0.25 | 0.69 | 33.4 | 0.15 | 18.0 |
| 2.0 | 0.27 | 0.66 | 38.1 | 0.14 | 17.7 |
| 2.5 | 0.33 | 0.60 | 50.6 | 0.13 | 17.0 |
| 3.0 | 0.39 | 0.54 | 64.2 | 0.12 | 16.2 |
| 4.0 | 0.52 | 0.45 | 94.0 | 0.10 | 14.8 |
| 5.0 | 0.64 | 0.39 | 126.5 | 0.07 | 13.5 |
| 6.0 | 0.77 | 0.34 | 160.6 | 0.05 | 12.4 |
| 7.0 | 0.90 | 0.33 | -164.7 | 0.06 | 11.4 |
| 8.0 | 1.02 | 0.33 | -130.3 | 0.10 | 10.5 |
| 9.0 | 1.15 | 0.36 | -97.5 | 0.18 | 9.7 |
| 10.0 | 1.28 | 0.40 | -67.0 | 0.30 | 9.1 |

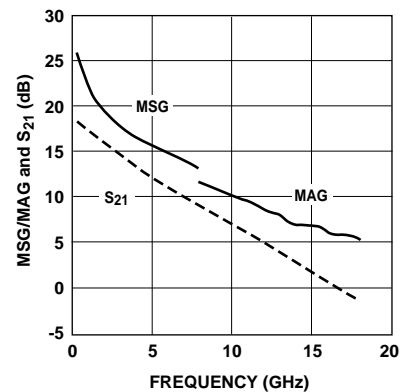

Figure 21. MSG/MAG and $|S_{21}|^2$ vs. Frequency at 2 V, 30 mA.

Notes:

- F_{\min} values at 2 GHz and higher are based on measurements while the F_{\min} s below 2 GHz have been extrapolated. The F_{\min} values are based on a set of 16 noise figure measurements made at 16 different impedances using an ATF NP5 test system. From these measurements a true F_{\min} is calculated. Refer to the noise parameter application section for more information.
- S and noise parameters are measured on a microstrip line made on 0.025 inch thick alumina carrier. The input reference plane is at the end of the gate lead. The output reference plane is at the end of the drain lead. The parameters include the effect of four plated through via holes connecting source landing pads on top of the test carrier to the microstrip ground plane on the bottom side of the carrier. Two 0.020 inch diameter via holes are placed within 0.010 inch from each source lead contact point, one via on each side of that point.

ATF-35143 Typical Scattering Parameters, $V_{DS} = 3\text{ V}$, $I_{DS} = 10\text{ mA}$

| Freq. GHz | S_{11} | | S_{21} | | | S_{12} | | | S_{22} | | MSG/MAG dB |
|--------------|----------|---------|----------|------|---------|----------|-------|---------|----------|---------|---------------|
| | Mag. | Ang. | dB | Mag. | Ang. | dB | Mag. | Ang. | Mag. | Ang. | |
| 0.50 | 0.99 | -18.76 | 16.07 | 6.36 | 164.73 | -32.77 | 0.023 | 76.79 | 0.65 | -13.67 | 24.42 |
| 0.75 | 0.97 | -29.12 | 15.97 | 6.29 | 155.93 | -29.37 | 0.034 | 70.22 | 0.63 | -19.08 | 22.70 |
| 1.00 | 0.95 | -38.28 | 15.79 | 6.16 | 148.37 | -27.13 | 0.044 | 64.53 | 0.62 | -25.28 | 21.46 |
| 1.50 | 0.91 | -55.52 | 15.34 | 5.85 | 133.87 | -24.01 | 0.063 | 54.04 | 0.59 | -37.48 | 19.68 |
| 1.75 | 0.88 | -63.78 | 15.09 | 5.68 | 126.95 | -22.97 | 0.071 | 49.13 | 0.57 | -43.28 | 19.00 |
| 2.00 | 0.86 | -71.79 | 14.82 | 5.51 | 120.22 | -22.05 | 0.079 | 44.06 | 0.56 | -49.01 | 18.43 |
| 2.50 | 0.81 | -87.55 | 14.27 | 5.17 | 107.29 | -20.82 | 0.091 | 34.85 | 0.52 | -59.84 | 17.55 |
| 3.00 | 0.75 | -103.15 | 13.71 | 4.85 | 95.00 | -19.83 | 0.102 | 25.98 | 0.49 | -69.88 | 16.77 |
| 4.00 | 0.66 | -134.65 | 12.56 | 4.25 | 71.95 | -18.71 | 0.116 | 9.56 | 0.42 | -87.88 | 15.63 |
| 5.00 | 0.60 | -165.16 | 11.45 | 3.74 | 50.50 | -18.13 | 0.124 | -5.10 | 0.35 | -105.14 | 14.79 |
| 6.00 | 0.58 | 166.12 | 10.43 | 3.32 | 30.44 | -17.79 | 0.129 | -19.00 | 0.29 | -122.61 | 14.11 |
| 7.00 | 0.56 | 137.25 | 9.44 | 2.97 | 10.91 | -17.65 | 0.131 | -32.32 | 0.23 | -141.22 | 13.55 |
| 8.00 | 0.57 | 111.11 | 8.51 | 2.66 | -7.80 | -17.59 | 0.132 | -43.61 | 0.18 | -162.07 | 12.81 |
| 9.00 | 0.60 | 87.10 | 7.51 | 2.38 | -26.05 | -17.65 | 0.131 | -55.14 | 0.13 | 172.01 | 10.75 |
| 10.00 | 0.64 | 66.58 | 6.64 | 2.15 | -43.52 | -17.65 | 0.131 | -65.42 | 0.10 | 139.11 | 9.98 |
| 11.00 | 0.68 | 47.31 | 5.76 | 1.94 | -61.59 | -17.65 | 0.131 | -76.27 | 0.11 | 93.44 | 9.32 |
| 12.00 | 0.71 | 28.18 | 4.81 | 1.74 | -79.58 | -17.72 | 0.130 | -87.47 | 0.16 | 57.88 | 8.54 |
| 13.00 | 0.74 | 9.02 | 3.71 | 1.53 | -96.96 | -17.99 | 0.126 | -98.60 | 0.23 | 35.32 | 7.59 |
| 14.00 | 0.77 | -4.82 | 2.61 | 1.35 | -112.95 | -18.34 | 0.121 | -107.41 | 0.29 | 13.11 | 6.76 |
| 15.00 | 0.82 | -15.65 | 1.60 | 1.20 | -128.77 | -18.56 | 0.118 | -116.63 | 0.35 | -4.62 | 6.79 |
| 16.00 | 0.82 | -28.00 | 0.51 | 1.06 | -145.23 | -18.71 | 0.116 | -126.02 | 0.42 | -19.61 | 5.79 |
| 17.00 | 0.84 | -40.11 | -0.55 | 0.94 | -160.01 | -18.71 | 0.116 | -136.14 | 0.49 | -29.62 | 5.54 |
| 18.00 | 0.86 | -55.87 | -1.68 | 0.82 | -176.05 | -19.25 | 0.109 | -146.13 | 0.55 | -41.92 | 5.05 |

ATF-35143 Typical Noise Parameters
 $V_{DS} = 3\text{ V}$, $I_{DS} = 10\text{ mA}$

| Freq. GHz | F_{min} dB | Γ_{opt} | | $R_{n/50}$ - | G_a dB |
|--------------|-----------------|----------------|--------|-----------------|-------------|
| | | Mag. | Ang. | | |
| 0.5 | 0.12 | 0.87 | 4.7 | 0.21 | 20.0 |
| 0.9 | 0.16 | 0.82 | 13.2 | 0.19 | 19.0 |
| 1.0 | 0.17 | 0.81 | 15.3 | 0.19 | 18.8 |
| 1.5 | 0.22 | 0.75 | 25.9 | 0.17 | 17.8 |
| 1.8 | 0.26 | 0.71 | 32.3 | 0.16 | 17.2 |
| 2.0 | 0.28 | 0.68 | 36.5 | 0.16 | 16.7 |
| 2.5 | 0.33 | 0.62 | 47.7 | 0.14 | 15.9 |
| 3.0 | 0.39 | 0.57 | 59.6 | 0.13 | 15.1 |
| 4.0 | 0.49 | 0.49 | 85.4 | 0.10 | 13.7 |
| 5.0 | 0.60 | 0.43 | 113.6 | 0.08 | 12.5 |
| 6.0 | 0.71 | 0.38 | 143.7 | 0.05 | 11.4 |
| 7.0 | 0.81 | 0.36 | 175.6 | 0.05 | 10.4 |
| 8.0 | 0.92 | 0.34 | -151.3 | 0.07 | 9.6 |
| 9.0 | 1.03 | 0.34 | -117.3 | 0.12 | 8.9 |
| 10.0 | 1.13 | 0.35 | -82.7 | 0.21 | 8.4 |

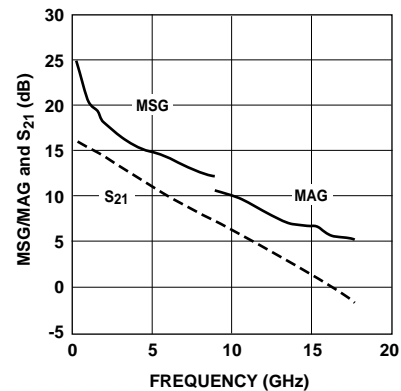

Figure 22. MSG/MAG and $|S_{21}|^2$ vs. Frequency at 3 V, 10 mA.

Notes:

- F_{min} values at 2 GHz and higher are based on measurements while the F_{min} s below 2 GHz have been extrapolated. The F_{min} values are based on a set of 16 noise figure measurements made at 16 different impedances using an ATN NP5 test system. From these measurements a true F_{min} is calculated. Refer to the noise parameter application section for more information.
- S and noise parameters are measured on a microstrip line made on 0.025 inch thick alumina carrier. The input reference plane is at the end of the gate lead. The output reference plane is at the end of the drain lead. The parameters include the effect of four plated through via holes connecting source landing pads on top of the test carrier to the microstrip ground plane on the bottom side of the carrier. Two 0.020 inch diameter via holes are placed within 0.010 inch from each source lead contact point, one via on each side of that point.

ATF-35143 Typical Scattering Parameters, $V_{DS} = 3\text{ V}$, $I_{DS} = 15\text{ mA}$

| Freq. GHz | S_{11} | | S_{21} | | | S_{12} | | | S_{22} | | MSG/MAG dB |
|--------------|----------|---------|----------|------|---------|----------|-------|---------|----------|---------|---------------|
| | Mag. | Ang. | dB | Mag. | Ang. | dB | Mag. | Ang. | Mag. | Ang. | |
| 0.50 | 0.99 | -19.76 | 17.20 | 7.24 | 164.03 | -33.15 | 0.022 | 76.95 | 0.60 | -14.39 | 25.17 |
| 0.75 | 0.96 | -30.58 | 17.08 | 7.14 | 154.94 | -29.90 | 0.032 | 69.88 | 0.58 | -20.00 | 23.47 |
| 1.00 | 0.94 | -40.14 | 16.86 | 6.97 | 147.12 | -27.54 | 0.042 | 64.59 | 0.57 | -26.48 | 22.20 |
| 1.50 | 0.90 | -58.04 | 16.35 | 6.57 | 132.22 | -24.58 | 0.059 | 54.00 | 0.54 | -39.05 | 20.47 |
| 1.75 | 0.87 | -66.61 | 16.06 | 6.35 | 125.16 | -23.48 | 0.067 | 49.23 | 0.52 | -45.00 | 19.78 |
| 2.00 | 0.84 | -74.88 | 15.75 | 6.13 | 118.36 | -22.62 | 0.074 | 44.39 | 0.50 | -50.83 | 19.19 |
| 2.50 | 0.78 | -91.02 | 15.13 | 5.71 | 105.32 | -21.41 | 0.085 | 35.29 | 0.47 | -61.71 | 18.27 |
| 3.00 | 0.73 | -106.95 | 14.50 | 5.31 | 93.02 | -20.45 | 0.102 | 27.00 | 0.44 | -71.87 | 17.47 |
| 4.00 | 0.63 | -138.86 | 13.24 | 4.59 | 70.17 | -19.41 | 0.107 | 11.47 | 0.37 | -89.81 | 16.32 |
| 5.00 | 0.58 | -169.42 | 12.05 | 4.00 | 49.09 | -18.79 | 0.115 | -2.18 | 0.31 | -107.23 | 15.42 |
| 6.00 | 0.56 | 162.05 | 10.97 | 3.53 | 29.39 | -18.34 | 0.121 | -15.36 | 0.24 | -125.21 | 14.66 |
| 7.00 | 0.55 | 133.54 | 9.93 | 3.14 | 10.23 | -18.06 | 0.125 | -27.97 | 0.19 | -145.42 | 14.00 |
| 8.00 | 0.56 | 107.88 | 8.96 | 2.81 | -8.11 | -17.92 | 0.127 | -38.89 | 0.14 | -168.81 | 12.23 |
| 9.00 | 0.60 | 84.56 | 7.95 | 2.50 | -26.04 | -17.86 | 0.128 | -50.41 | 0.11 | 158.79 | 10.87 |
| 10.00 | 0.64 | 64.57 | 7.06 | 2.26 | -43.28 | -17.72 | 0.130 | -60.57 | 0.09 | 118.59 | 10.16 |
| 11.00 | 0.68 | 45.84 | 6.16 | 2.03 | -61.06 | -17.59 | 0.132 | -71.45 | 0.12 | 75.36 | 9.55 |
| 12.00 | 0.71 | 27.11 | 5.19 | 1.82 | -78.75 | -17.59 | 0.132 | -83.32 | 0.18 | 46.94 | 8.80 |
| 13.00 | 0.74 | 8.18 | 4.09 | 1.60 | -95.88 | -17.79 | 0.129 | -94.36 | 0.25 | 27.91 | 7.86 |
| 14.00 | 0.77 | -5.58 | 2.98 | 1.41 | -111.57 | -18.06 | 0.125 | -103.78 | 0.31 | 7.94 | 7.09 |
| 15.00 | 0.82 | -16.18 | 1.96 | 1.25 | -127.09 | -18.27 | 0.122 | -113.43 | 0.37 | -8.87 | 7.04 |
| 16.00 | 0.82 | -28.41 | 0.88 | 1.11 | -143.31 | -18.42 | 0.120 | -123.35 | 0.44 | -23.42 | 6.09 |
| 17.00 | 0.85 | -40.49 | -0.15 | 0.98 | -157.87 | -18.49 | 0.119 | -134.06 | 0.50 | -32.96 | 5.87 |
| 18.00 | 0.86 | -56.20 | -1.25 | 0.87 | -173.65 | -18.86 | 0.114 | -144.46 | 0.56 | -44.64 | 5.41 |

ATF-35143 Typical Noise Parameters
 $V_{DS} = 3\text{ V}$, $I_{DS} = 15\text{ mA}$

| Freq. GHz | F_{min} dB | Γ_{opt} | | $R_{n/50}$ - | G_a dB |
|--------------|-----------------|----------------|--------|-----------------|-------------|
| | | Mag. | Ang. | | |
| 0.5 | 0.11 | 0.86 | 3.5 | 0.17 | 21.2 |
| 0.9 | 0.15 | 0.81 | 12.1 | 0.16 | 19.9 |
| 1.0 | 0.16 | 0.80 | 14.3 | 0.16 | 19.6 |
| 1.5 | 0.21 | 0.73 | 25.1 | 0.15 | 18.2 |
| 1.8 | 0.24 | 0.69 | 31.6 | 0.14 | 17.6 |
| 2.0 | 0.26 | 0.66 | 35.9 | 0.20 | 17.2 |
| 2.5 | 0.31 | 0.60 | 47.2 | 0.17 | 16.3 |
| 3.0 | 0.37 | 0.55 | 59.4 | 0.15 | 15.6 |
| 4.0 | 0.47 | 0.46 | 86.0 | 0.11 | 14.2 |
| 5.0 | 0.58 | 0.40 | 115.4 | 0.07 | 12.9 |
| 6.0 | 0.68 | 0.36 | 146.8 | 0.05 | 11.8 |
| 7.0 | 0.79 | 0.33 | 179.8 | 0.05 | 10.8 |
| 8.0 | 0.89 | 0.32 | -146.1 | 0.07 | 10.0 |
| 9.0 | 1.00 | 0.32 | -111.5 | 0.13 | 9.3 |
| 10.0 | 1.10 | 0.33 | -76.8 | 0.22 | 8.8 |

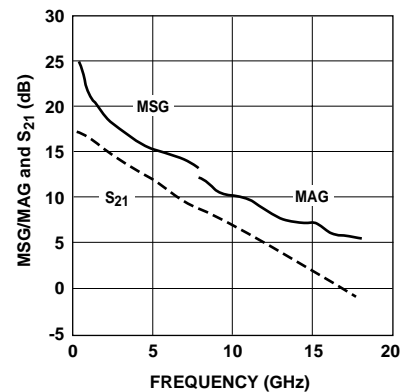

Figure 23. MSG/MAG and $|S_{21}|^2$ vs. Frequency at 3 V, 15 mA.

Notes:

- F_{min} values at 2 GHz and higher are based on measurements while the F_{min} s below 2 GHz have been extrapolated. The F_{min} values are based on a set of 16 noise figure measurements made at 16 different impedances using an ATN NP5 test system. From these measurements a true F_{min} is calculated. Refer to the noise parameter application section for more information.
- S and noise parameters are measured on a microstrip line made on 0.025 inch thick alumina carrier. The input reference plane is at the end of the gate lead. The output reference plane is at the end of the drain lead. The parameters include the effect of four plated through via holes connecting source landing pads on top of the test carrier to the microstrip ground plane on the bottom side of the carrier. Two 0.020 inch diameter via holes are placed within 0.010 inch from each source lead contact point, one via on each side of

ATF-35143 Typical Scattering Parameters, $V_{DS} = 3\text{ V}$, $I_{DS} = 30\text{ mA}$

| Freq. GHz | S_{11} | | S_{21} | | | S_{12} | | | S_{22} | | MSG/MAG dB |
|--------------|----------|---------|----------|------|---------|----------|-------|---------|----------|---------|---------------|
| | Mag. | Ang. | dB | Mag. | Ang. | dB | Mag. | Ang. | Mag. | Ang. | |
| 0.50 | 0.99 | -21.01 | 18.45 | 8.36 | 163.08 | -33.98 | 0.020 | 76.89 | 0.53 | -15.23 | 26.21 |
| 0.75 | 0.96 | -32.39 | 18.29 | 8.21 | 153.62 | -30.46 | 0.030 | 69.94 | 0.51 | -21.01 | 24.36 |
| 1.00 | 0.93 | -42.42 | 18.03 | 7.97 | 145.49 | -28.40 | 0.038 | 64.80 | 0.50 | -27.72 | 23.22 |
| 1.50 | 0.88 | -61.18 | 17.42 | 7.43 | 130.11 | -25.35 | 0.054 | 54.32 | 0.47 | -40.61 | 21.39 |
| 1.75 | 0.85 | -70.01 | 17.09 | 7.15 | 122.91 | -24.44 | 0.060 | 49.77 | 0.45 | -46.56 | 20.72 |
| 2.00 | 0.82 | -78.57 | 16.74 | 6.87 | 116.00 | -23.61 | 0.066 | 45.15 | 0.43 | -52.43 | 20.17 |
| 2.50 | 0.76 | -95.09 | 16.03 | 6.33 | 102.87 | -22.38 | 0.076 | 36.87 | 0.40 | -63.37 | 19.21 |
| 3.00 | 0.70 | -111.30 | 15.32 | 5.83 | 90.60 | -21.41 | 0.085 | 29.08 | 0.37 | -73.44 | 18.36 |
| 4.00 | 0.61 | -143.48 | 13.93 | 4.97 | 68.04 | -20.26 | 0.097 | 14.96 | 0.31 | -91.21 | 17.10 |
| 5.00 | 0.56 | -174.00 | 12.65 | 4.29 | 47.37 | -19.58 | 0.105 | 2.38 | 0.25 | -108.94 | 16.11 |
| 6.00 | 0.54 | 157.98 | 11.50 | 3.76 | 28.09 | -19.02 | 0.112 | -10.00 | 0.19 | -128.04 | 15.26 |
| 7.00 | 0.54 | 130.06 | 10.42 | 3.32 | 9.32 | -18.64 | 0.117 | -22.21 | 0.14 | -151.53 | 13.78 |
| 8.00 | 0.55 | 105.20 | 9.42 | 2.96 | -8.66 | -18.34 | 0.121 | -32.79 | 0.11 | 179.40 | 12.10 |
| 9.00 | 0.59 | 82.53 | 8.39 | 2.63 | -26.26 | -18.06 | 0.125 | -44.11 | 0.09 | 138.30 | 11.00 |
| 10.00 | 0.63 | 63.18 | 7.49 | 2.37 | -43.25 | -17.79 | 0.129 | -54.57 | 0.09 | 95.15 | 10.36 |
| 11.00 | 0.67 | 44.96 | 6.56 | 2.13 | -60.82 | -17.52 | 0.133 | -66.16 | 0.14 | 62.17 | 9.76 |
| 12.00 | 0.71 | 26.64 | 5.58 | 1.90 | -78.23 | -17.46 | 0.134 | -78.18 | 0.20 | 39.86 | 9.05 |
| 13.00 | 0.74 | 7.94 | 4.46 | 1.67 | -95.07 | -17.65 | 0.131 | -89.74 | 0.27 | 23.41 | 8.14 |
| 14.00 | 0.77 | -5.53 | 3.36 | 1.47 | -110.42 | -17.86 | 0.128 | -99.72 | 0.34 | 5.08 | 7.40 |
| 15.00 | 0.82 | -16.02 | 2.33 | 1.31 | -125.79 | -17.99 | 0.126 | -109.60 | 0.39 | -11.42 | 7.41 |
| 16.00 | 0.82 | -28.09 | 1.25 | 1.16 | -141.72 | -18.06 | 0.125 | -120.39 | 0.46 | -25.74 | 6.44 |
| 17.00 | 0.85 | -40.02 | 0.23 | 1.03 | -156.00 | -18.06 | 0.125 | -131.03 | 0.51 | -35.29 | 6.19 |
| 18.00 | 0.87 | -55.63 | -0.85 | 0.91 | -171.48 | -18.49 | 0.119 | -141.69 | 0.57 | -46.81 | 5.71 |

ATF-35143 Typical Noise Parameters
 $V_{DS} = 3\text{ V}$, $I_{DS} = 30\text{ mA}$

| Freq. GHz | F_{min} dB | Γ_{opt} | | $R_{n/50}$ - | G_a dB |
|--------------|-----------------|----------------|--------|-----------------|-------------|
| | | Mag. | Ang. | | |
| 0.5 | 0.11 | 0.87 | 3.5 | 0.18 | 21.6 |
| 0.9 | 0.16 | 0.81 | 12.5 | 0.17 | 20.5 |
| 1.0 | 0.17 | 0.79 | 14.7 | 0.17 | 20.2 |
| 1.5 | 0.23 | 0.72 | 25.9 | 0.16 | 18.9 |
| 1.8 | 0.27 | 0.68 | 32.6 | 0.15 | 18.3 |
| 2.0 | 0.28 | 0.65 | 37.1 | 0.15 | 17.9 |
| 2.5 | 0.35 | 0.59 | 49.3 | 0.14 | 17.0 |
| 3.0 | 0.41 | 0.53 | 62.5 | 0.12 | 16.3 |
| 4.0 | 0.53 | 0.43 | 91.6 | 0.09 | 14.9 |
| 5.0 | 0.66 | 0.37 | 123.4 | 0.07 | 13.6 |
| 6.0 | 0.79 | 0.33 | 157.1 | 0.05 | 12.4 |
| 7.0 | 0.91 | 0.31 | -168.3 | 0.06 | 11.4 |
| 8.0 | 1.04 | 0.31 | -133.7 | 0.10 | 10.6 |
| 9.0 | 1.17 | 0.33 | -100.0 | 0.17 | 9.9 |
| 10.0 | 1.29 | 0.38 | -68.1 | 0.28 | 9.3 |

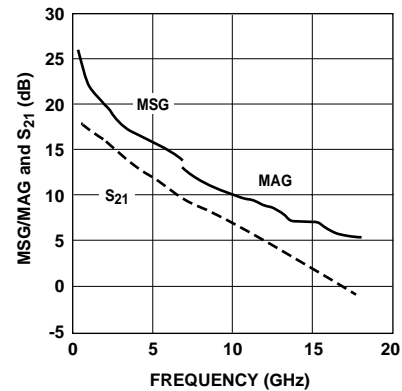

Figure 24. MSG/MAG and $|S_{21}|^2$ vs. Frequency at 3 V, 30 mA.

Notes:

- F_{min} values at 2 GHz and higher are based on measurements while the F_{min} s below 2 GHz have been extrapolated. The F_{min} values are based on a set of 16 noise figure measurements made at 16 different impedances using an ATN NP5 test system. From these measurements a true F_{min} is calculated. Refer to the noise parameter application section for more information.
- S and noise parameters are measured on a microstrip line made on 0.025 inch thick alumina carrier. The input reference plane is at the end of the gate lead. The output reference plane is at the end of the drain lead. The parameters include the effect of four plated through via holes connecting source landing pads on top of the test carrier to the microstrip ground plane on the bottom side of the carrier. Two 0.020 inch diameter via holes are placed within 0.010 inch from each source lead contact point, one via on each side of

ATF-35143 Typical Scattering Parameters, $V_{DS} = 4\text{ V}$, $I_{DS} = 30\text{ mA}$

| Freq. GHz | S_{11} | | S_{21} | | | S_{12} | | | S_{22} | | MSG/MAG dB |
|--------------|----------|---------|----------|------|---------|----------|-------|---------|----------|---------|---------------|
| | Mag. | Ang. | dB | Mag. | Ang. | dB | Mag. | Ang. | Mag. | Ang. | |
| 0.50 | 0.99 | -21.11 | 18.54 | 8.45 | 163.20 | -33.98 | 0.020 | 77.63 | 0.56 | -14.66 | 26.26 |
| 0.75 | 0.96 | -32.57 | 18.38 | 8.30 | 153.72 | -30.75 | 0.029 | 70.15 | 0.54 | -20.35 | 24.55 |
| 1.00 | 0.94 | -42.70 | 18.13 | 8.07 | 145.56 | -28.64 | 0.037 | 64.68 | 0.53 | -26.91 | 23.38 |
| 1.50 | 0.88 | -61.55 | 17.53 | 7.53 | 130.19 | -25.68 | 0.052 | 53.94 | 0.50 | -39.45 | 21.61 |
| 1.75 | 0.85 | -70.46 | 17.20 | 7.24 | 123.00 | -24.58 | 0.059 | 49.29 | 0.48 | -45.29 | 20.90 |
| 2.00 | 0.82 | -79.07 | 16.84 | 6.95 | 116.04 | -23.88 | 0.064 | 44.64 | 0.46 | -50.94 | 20.36 |
| 2.50 | 0.76 | -95.78 | 16.14 | 6.41 | 102.91 | -22.62 | 0.074 | 36.30 | 0.43 | -61.54 | 19.38 |
| 3.00 | 0.71 | -112.14 | 15.43 | 5.91 | 90.63 | -21.72 | 0.082 | 28.32 | 0.40 | -71.17 | 18.58 |
| 4.00 | 0.62 | -144.46 | 14.04 | 5.03 | 68.03 | -20.72 | 0.092 | 13.98 | 0.34 | -87.95 | 17.38 |
| 5.00 | 0.57 | -174.93 | 12.76 | 4.34 | 47.35 | -20.00 | 0.100 | 1.12 | 0.28 | -104.23 | 16.38 |
| 6.00 | 0.55 | 157.13 | 11.61 | 3.81 | 28.07 | -19.49 | 0.106 | -11.07 | 0.22 | -120.69 | 15.55 |
| 7.00 | 0.55 | 129.56 | 10.54 | 3.37 | 9.35 | -19.25 | 0.109 | -23.07 | 0.17 | -139.29 | 14.19 |
| 8.00 | 0.57 | 104.96 | 9.55 | 3.00 | -8.62 | -18.94 | 0.113 | -33.33 | 0.13 | -160.54 | 12.47 |
| 9.00 | 0.60 | 82.47 | 8.53 | 2.67 | -26.19 | -18.79 | 0.115 | -44.34 | 0.09 | 169.67 | 11.33 |
| 10.00 | 0.64 | 63.23 | 7.64 | 2.41 | -43.13 | -18.49 | 0.119 | -54.44 | 0.07 | 128.74 | 10.70 |
| 11.00 | 0.68 | 45.01 | 6.74 | 2.17 | -60.63 | -18.27 | 0.122 | -65.68 | 0.09 | 78.47 | 10.10 |
| 12.00 | 0.72 | 26.69 | 5.79 | 1.95 | -78.09 | -18.13 | 0.124 | -77.35 | 0.15 | 47.96 | 9.40 |
| 13.00 | 0.74 | 8.00 | 4.71 | 1.72 | -95.00 | -18.27 | 0.122 | -88.59 | 0.22 | 28.53 | 8.47 |
| 14.00 | 0.77 | -5.46 | 3.64 | 1.52 | -110.50 | -18.42 | 0.120 | -98.13 | 0.28 | 8.38 | 7.69 |
| 15.00 | 0.82 | -16.18 | 2.65 | 1.36 | -126.04 | -18.49 | 0.119 | -108.03 | 0.34 | -8.46 | 7.76 |
| 16.00 | 0.82 | -28.39 | 1.62 | 1.21 | -142.14 | -18.49 | 0.119 | -118.41 | 0.40 | -22.93 | 6.75 |
| 17.00 | 0.85 | -40.51 | 0.64 | 1.08 | -156.61 | -18.49 | 0.119 | -129.54 | 0.46 | -32.29 | 6.53 |
| 18.00 | 0.86 | -56.36 | -0.44 | 0.95 | -172.55 | -18.86 | 0.114 | -140.19 | 0.52 | -43.97 | 6.00 |

ATF-35143 Typical Noise Parameters
 $V_{DS} = 4\text{ V}$, $I_{DS} = 30\text{ mA}$

| Freq. GHz | F_{min} dB | Γ_{opt} | | $R_{n/50}$ - | G_a dB |
|--------------|-----------------|----------------|--------|-----------------|-------------|
| | | Mag. | Ang. | | |
| 0.5 | 0.10 | 0.90 | 3.5 | 0.22 | 20.7 |
| 0.9 | 0.14 | 0.85 | 12.5 | 0.21 | 19.7 |
| 1.0 | 0.16 | 0.83 | 14.7 | 0.20 | 19.5 |
| 1.5 | 0.21 | 0.77 | 25.9 | 0.18 | 18.4 |
| 1.8 | 0.25 | 0.73 | 32.6 | 0.17 | 17.8 |
| 2.0 | 0.28 | 0.70 | 37.1 | 0.17 | 17.5 |
| 2.5 | 0.33 | 0.64 | 49.1 | 0.15 | 16.7 |
| 3.0 | 0.38 | 0.58 | 62.0 | 0.14 | 16.0 |
| 4.0 | 0.49 | 0.48 | 90.3 | 0.10 | 14.7 |
| 5.0 | 0.62 | 0.40 | 121.2 | 0.07 | 13.5 |
| 6.0 | 0.74 | 0.35 | 154.0 | 0.05 | 12.5 |
| 7.0 | 0.87 | 0.32 | -172.2 | 0.06 | 11.5 |
| 8.0 | 0.99 | 0.31 | -138.0 | 0.09 | 10.7 |
| 9.0 | 1.11 | 0.34 | -104.2 | 0.15 | 10.0 |
| 10.0 | 1.24 | 0.39 | -71.6 | 0.26 | 9.5 |

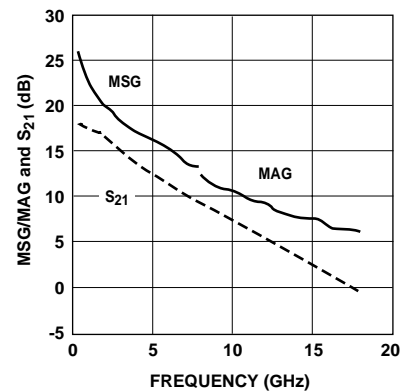

Figure 25. MSG/MAG and $|S_{21}|^2$ vs. Frequency at 4 V, 30 mA.

Notes:

- F_{min} values at 2 GHz and higher are based on measurements while the F_{min} s below 2 GHz have been extrapolated. The F_{min} values are based on a set of 16 noise figure measurements made at 16 different impedances using an ATN NP5 test system. From these measurements a true F_{min} is calculated. Refer to the noise parameter application section for more information.
- S and noise parameters are measured on a microstrip line made on 0.025 inch thick alumina carrier. The input reference plane is at the end of the gate lead. The output reference plane is at the end of the drain lead. The parameters include the effect of four plated through via holes connecting source landing pads on top of the test carrier to the microstrip ground plane on the bottom side of the carrier. Two 0.020 inch diameter via holes are placed within 0.010 inch from each source lead contact point, one via on each side of that point.

ATF-35143 Typical Scattering Parameters, $V_{DS} = 4\text{ V}$, $I_{DS} = 60\text{ mA}$

| Freq. GHz | S_{11} | | dB | S_{21} | | dB | S_{12} | | S_{22} | | MSG/MAG dB |
|--------------|----------|---------|-------|----------|---------|--------|----------|---------|----------|---------|---------------|
| | Mag. | Ang. | | Mag. | Ang. | | Mag. | Ang. | Mag. | Ang. | |
| 0.50 | 0.99 | -21.27 | 18.15 | 8.09 | 163.09 | -34.89 | 0.018 | 77.28 | 0.54 | -13.50 | 26.52 |
| 0.75 | 0.96 | -32.77 | 17.99 | 7.94 | 153.59 | -31.70 | 0.026 | 70.40 | 0.53 | -18.54 | 24.83 |
| 1.00 | 0.94 | -42.95 | 17.74 | 7.71 | 145.40 | -29.37 | 0.034 | 65.05 | 0.51 | -24.50 | 23.55 |
| 1.50 | 0.88 | -61.92 | 17.13 | 7.19 | 129.98 | -26.56 | 0.047 | 55.14 | 0.48 | -35.90 | 21.84 |
| 1.75 | 0.85 | -70.88 | 16.79 | 6.91 | 122.76 | -25.51 | 0.053 | 50.40 | 0.47 | -41.17 | 21.15 |
| 2.00 | 0.82 | -79.55 | 16.45 | 6.64 | 115.80 | -24.73 | 0.058 | 46.34 | 0.45 | -46.33 | 20.59 |
| 2.50 | 0.76 | -96.36 | 15.74 | 6.12 | 102.60 | -23.48 | 0.067 | 38.10 | 0.42 | -55.86 | 19.61 |
| 3.00 | 0.70 | -112.86 | 15.03 | 5.64 | 90.26 | -22.62 | 0.074 | 30.61 | 0.39 | -64.53 | 18.82 |
| 4.00 | 0.61 | -145.47 | 13.64 | 4.81 | 67.52 | -21.51 | 0.084 | 17.18 | 0.34 | -79.32 | 17.58 |
| 5.00 | 0.57 | -176.15 | 12.35 | 4.15 | 46.76 | -20.82 | 0.091 | 5.47 | 0.29 | -93.48 | 16.59 |
| 6.00 | 0.55 | 155.85 | 11.21 | 3.64 | 27.45 | -20.26 | 0.097 | -5.83 | 0.24 | -107.07 | 15.74 |
| 7.00 | 0.55 | 128.25 | 10.14 | 3.21 | 8.68 | -19.83 | 0.102 | -17.10 | 0.19 | -121.43 | 13.17 |
| 8.00 | 0.57 | 103.61 | 9.16 | 2.87 | -9.34 | -19.41 | 0.107 | -26.34 | 0.15 | -137.04 | 11.94 |
| 9.00 | 0.60 | 81.11 | 8.14 | 2.55 | -27.02 | -19.09 | 0.111 | -36.93 | 0.11 | -156.16 | 10.99 |
| 10.00 | 0.64 | 62.01 | 7.25 | 2.30 | -44.01 | -18.71 | 0.116 | -46.43 | 0.07 | -178.65 | 10.38 |
| 11.00 | 0.69 | 43.90 | 6.37 | 2.08 | -61.57 | -18.27 | 0.122 | -57.09 | 0.06 | -113.63 | 9.88 |
| 12.00 | 0.72 | 25.78 | 5.43 | 1.87 | -79.17 | -17.92 | 0.127 | -68.92 | 0.10 | 60.75 | 9.26 |
| 13.00 | 0.75 | 7.31 | 4.37 | 1.65 | -96.36 | -17.92 | 0.127 | -80.43 | 0.18 | 35.69 | 8.35 |
| 14.00 | 0.78 | -6.12 | 3.30 | 1.46 | -112.19 | -17.92 | 0.127 | -90.26 | 0.25 | 13.24 | 7.57 |
| 15.00 | 0.83 | -16.62 | 2.29 | 1.30 | -127.94 | -17.86 | 0.128 | -100.79 | 0.31 | -4.12 | 7.78 |
| 16.00 | 0.84 | -28.78 | 1.25 | 1.16 | -144.27 | -17.79 | 0.129 | -112.14 | 0.39 | -19.12 | 6.73 |
| 17.00 | 0.87 | -40.91 | 0.21 | 1.03 | -159.19 | -17.79 | 0.129 | -123.71 | 0.46 | -28.89 | 6.65 |
| 18.00 | 0.88 | -56.66 | -0.92 | 0.90 | -175.28 | -17.99 | 0.126 | -134.88 | 0.52 | -40.92 | 6.06 |

ATF-35143 Typical Noise Parameters
 $V_{DS} = 4\text{ V}$, $I_{DS} = 60\text{ mA}$

| Freq. GHz | F_{min} dB | Γ_{opt} | | $R_{n/50}$ - | G_a dB |
|--------------|-----------------|----------------|--------|-----------------|-------------|
| | | Mag. | Ang. | | |
| 0.5 | 0.22 | 0.84 | 4.4 | 0.29 | 22.5 |
| 0.9 | 0.30 | 0.78 | 15.6 | 0.29 | 21.3 |
| 1.0 | 0.32 | 0.77 | 18.4 | 0.28 | 21.0 |
| 1.5 | 0.42 | 0.70 | 32.4 | 0.26 | 19.8 |
| 1.8 | 0.48 | 0.65 | 40.8 | 0.25 | 19.2 |
| 2.0 | 0.52 | 0.63 | 46.4 | 0.24 | 18.8 |
| 2.5 | 0.63 | 0.56 | 61.0 | 0.21 | 17.8 |
| 3.0 | 0.73 | 0.51 | 76.6 | 0.19 | 17.0 |
| 4.0 | 0.94 | 0.44 | 109.9 | 0.13 | 15.5 |
| 5.0 | 1.15 | 0.40 | 144.8 | 0.09 | 14.1 |
| 6.0 | 1.35 | 0.39 | -179.8 | 0.08 | 12.9 |
| 7.0 | 1.56 | 0.40 | -145.5 | 0.13 | 11.9 |
| 8.0 | 1.77 | 0.43 | -113.7 | 0.26 | 11.0 |
| 9.0 | 1.98 | 0.47 | -85.6 | 0.48 | 10.3 |
| 10.0 | 2.18 | 0.53 | -62.6 | 0.79 | 9.8 |

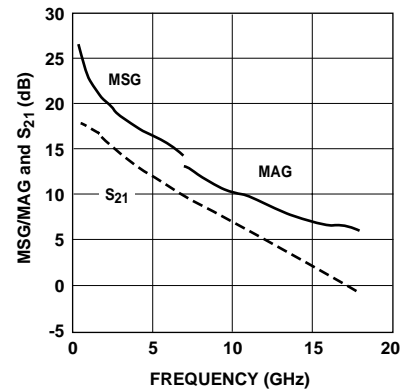

Figure 26. MSG/MAG and $|S_{21}|^2$ vs. Frequency at 4 V, 60 mA.

Notes:

- F_{min} values at 2 GHz and higher are based on measurements while the F_{min} s below 2 GHz have been extrapolated. The F_{min} values are based on a set of 16 noise figure measurements made at 16 different impedances using an ATN NP5 test system. From these measurements a true F_{min} is calculated. Refer to the noise parameter application section for more information.
- S and noise parameters are measured on a microstrip line made on 0.025 inch thick alumina carrier. The input reference plane is at the end of the gate lead. The output reference plane is at the end of the drain lead. The parameters include the effect of four plated through via holes connecting source landing pads on top of the test carrier to the microstrip ground plane on the bottom side of the carrier. Two 0.020 inch diameter via holes are placed within 0.010 inch from each source lead contact point, one via on each side of that point.

Noise Parameter Applications Information

F_{\min} values at 2 GHz and higher are based on measurements while the F_{\min} s below 2 GHz have been extrapolated. The F_{\min} values are based on a set of 16 noise figure measurements made at 16 different impedances using an ATN NP5 test system. From these measurements, a true F_{\min} is calculated. F_{\min} represents the true minimum noise figure of the device when the device is presented with an impedance matching network that transforms the source impedance, typically 50Ω , to an impedance represented by the reflection coefficient Γ_o . The designer must design a matching network that will present Γ_o to the device with minimal associated circuit losses. The noise figure of the completed amplifier is equal to the noise figure of the device plus the losses of the matching network preceding the device. The noise figure of the device is equal to F_{\min} only when the device is

presented with Γ_o . If the reflection coefficient of the matching network is other than Γ_o , then the noise figure of the device will be greater than F_{\min} based on the following equation.

$$NF = F_{\min} + 4 \frac{R_n}{Z_o} \frac{|\Gamma_s - \Gamma_o|^2}{(1 + |\Gamma_o|^2)(1 - |\Gamma_s|^2)}$$

Where R_n/Z_o is the normalized noise resistance, Γ_o is the optimum reflection coefficient required to produce F_{\min} and Γ_s is the reflection coefficient of the source impedance actually presented to the device. The losses of the matching networks are non-zero and they will also add to the noise figure of the device creating a higher amplifier noise figure. The losses of the matching networks are related to the Q of the components and associated printed circuit board loss. Γ_o is typically fairly low at higher frequencies and increases as frequency is lowered. Larger gate width devices will typically have a lower Γ_o as compared to narrower gate width devices.

Typically for FETs, the higher Γ_o usually infers that an impedance much higher than 50Ω is required for the device to produce F_{\min} . At VHF frequencies and even lower L Band frequencies, the required impedance can be in the vicinity of several thousand ohms. Matching to such a high impedance requires very hi-Q components in order to minimize circuit losses. As an example at 900 MHz, when airwound coils ($Q > 100$) are used for matching networks, the loss can still be up to 0.25 dB which will add directly to the noise figure of the device. Using multilayer molded inductors with Qs in the 30 to 50 range results in additional loss over the airwound coil. Losses as high as 0.5 dB or greater add to the typical 0.15 dB F_{\min} of the device creating an amplifier noise figure of nearly 0.65 dB. A discussion concerning calculated and measured circuit losses and their effect on amplifier noise figure is covered in Agilent Application 1085.

ATF-35143 SC-70 4 Lead, High Frequency Model Optimized for 0.1 – 6.0 GHz

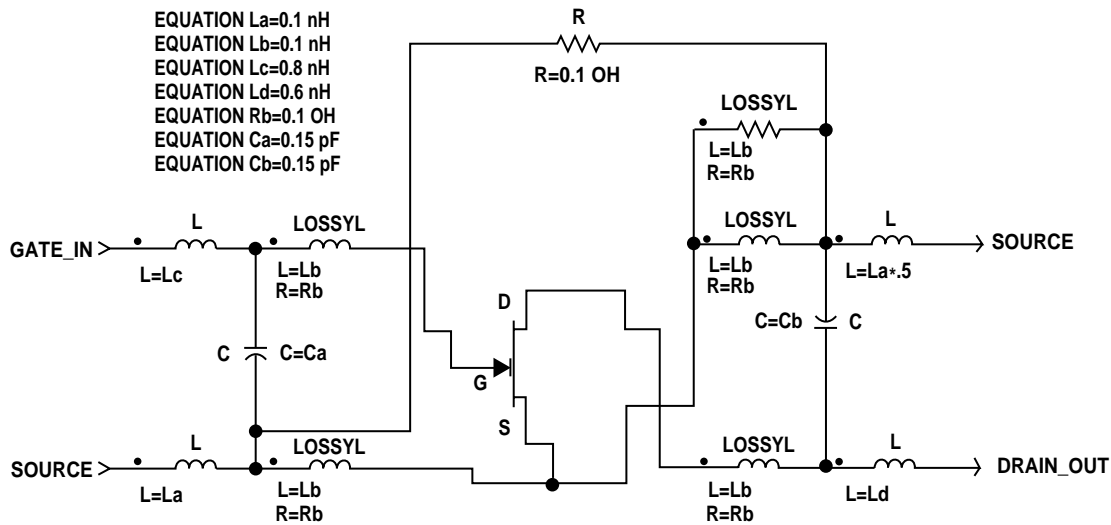

This model can be used as a design tool. It has been tested on MDS for various specifications. However, for more precise and accurate design, please refer to

the measured data in this data sheet. For future improvements Agilent reserves the right to change these models without prior notice.

ATF-35143 Die Model

| * STATZ MESFET MODEL * | | | | |
|------------------------|------------|------------|-----------|-----------|
| MODEL = FET | | | | |
| IDS model | Gate model | Parasitics | Breakdown | Noise |
| NFET=yes | DELTA=.2 | RG=1 | GSFWD=1 | FNC=01e+6 |
| PFET= | GSCAP=3 | RD=Rd | GSREV=0 | R=.17 |
| IDSMOD=3 | CGS=cgs pF | RS=Rs | GDFWD=1 | P=.65 |
| VTO=-0.95 | GDCAP=3 | LG=Lg nH | GDREV=0 | C=.2 |
| BETA= Beta | GCD=Cgd pF | LD=Ld nH | VJR=1 | |
| LAMBDA=0.09 | | LS=Ls nH | IS=1 nA | |
| ALPHA=4.0 | | CDS=Cds pF | IR=1 nA | |
| B=0.8 | | CRF=.1 | IMAX=.1 | |
| TNOM=27 | | RC=Rc | XTI= | |
| IDSTC= | | | N= | |
| VBI=.7 | | | EG= | |

Model scal factors (W=FET width in microns)

- EQUATION Cds=0.01*W/200
- EQUATION Beta=0.06*W/200
- EQUATION Rd=200/W
- EQUATION Rs=.5*200/W
- EQUATION Cgs=0.2*W/200
- EQUATION Cgd=0.04*W/200
- EQUATION Lg=0.03*200/W
- EQUATION Ld=0.03*200/W
- EQUATION Ls=0.01*200/W
- EQUATION Rc=500*200/W

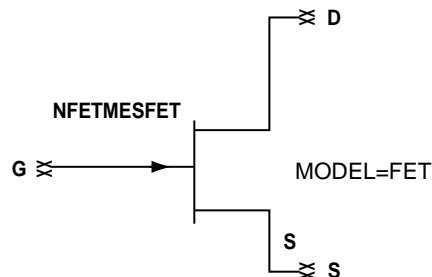

W=400 μm

Part Number Ordering Information

| Part Number | No. of Devices | Container |
|---------------|----------------|----------------|
| ATF-35143-TR1 | 3000 | 7" Reel |
| ATF-35143-TR2 | 10000 | 13" Reel |
| ATF-35143-BLK | 100 | antistatic bag |

Package Dimensions

Outline 43 (SOT-343/SC-70 4 lead)

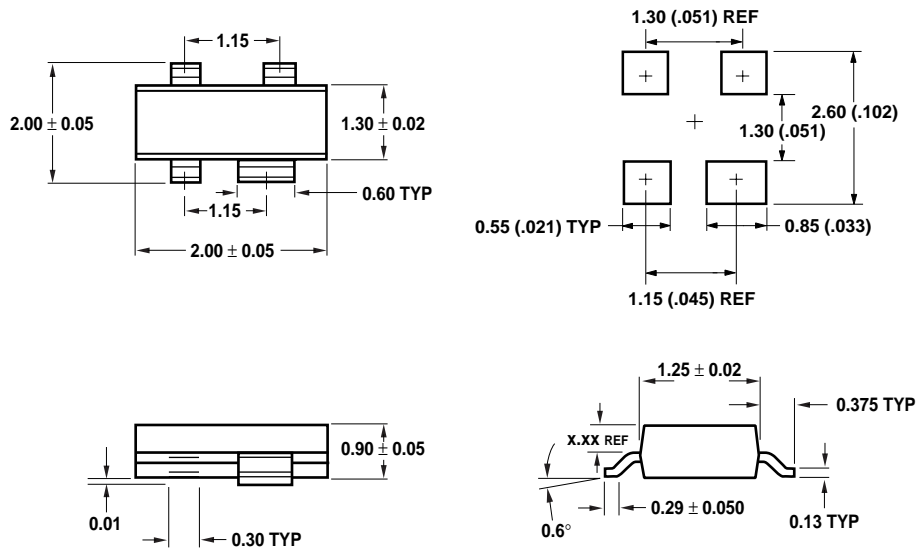

DIMENSIONS ARE IN MILLIMETERS (INCHES)

Device Orientation

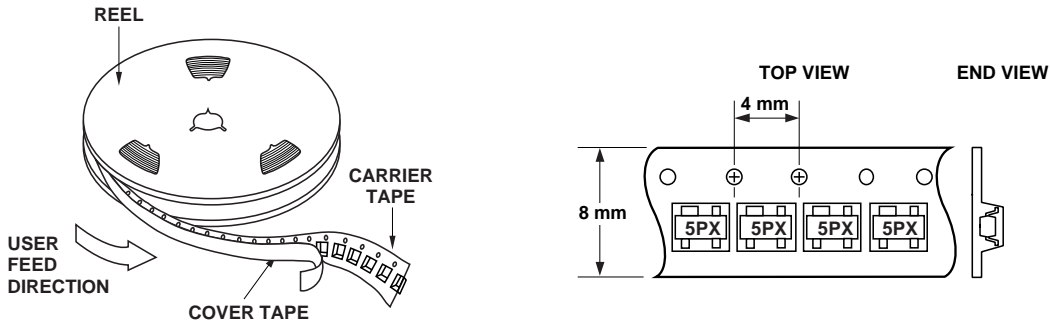

Tape Dimensions For Outline 4T

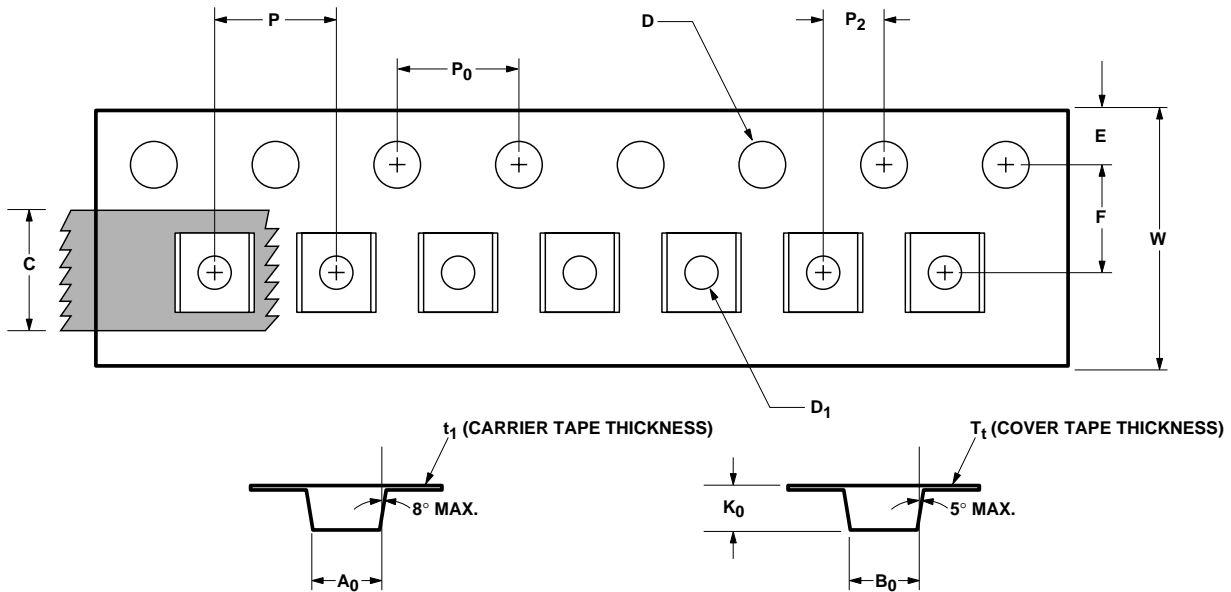

| DESCRIPTION | | SYMBOL | SIZE (mm) | SIZE (INCHES) |
|--|----------------------|---|---------------|------------------|
| CAVITY | LENGTH | A ₀ | 2.24 ± 0.10 | 0.088 ± 0.004 |
| | WIDTH | B ₀ | 2.34 ± 0.10 | 0.092 ± 0.004 |
| | DEPTH | K ₀ | 1.22 ± 0.10 | 0.048 ± 0.004 |
| | PITCH | P | 4.00 ± 0.10 | 0.157 ± 0.004 |
| | BOTTOM HOLE DIAMETER | D ₁ | 1.00 + 0.25 | 0.039 + 0.010 |
| | PERFORATION | DIAMETER | D | 1.55 ± 0.05 |
| PERFORATION | PITCH | P ₀ | 4.00 ± 0.10 | 0.157 ± 0.004 |
| | POSITION | E | 1.75 ± 0.10 | 0.069 ± 0.004 |
| | CARRIER TAPE | WIDTH | W | 8.00 ± 0.30 |
| CARRIER TAPE | THICKNESS | t ₁ | 0.255 ± 0.013 | 0.010 ± 0.0005 |
| | COVER TAPE | WIDTH | C | 5.4 ± 0.10 |
| COVER TAPE | TAPE THICKNESS | T _t | 0.062 ± 0.001 | 0.0025 ± 0.00004 |
| | DISTANCE | CAVITY TO PERFORATION (WIDTH DIRECTION) | F | 3.50 ± 0.05 |
| CAVITY TO PERFORATION (LENGTH DIRECTION) | | P ₂ | 2.00 ± 0.05 | 0.079 ± 0.002 |



Agilent Technologies
Innovating the HP Way

www.semiconductor.agilent.com

Data subject to change.

Copyright © 2000 Agilent Technologies, Inc.

Obsoletes 5968-5430E

5968-7826E (2/00)