

**SILICON MMIC LOW CURRENT AMPLIFIER
FOR MOBILE COMMUNICATIONS**

DESCRIPTION

The μ PC8179TB is a silicon monolithic integrated circuit designed as amplifier for mobile communications. This IC can realize low current consumption with external chip inductor which can not be realized on internal 50 Ω wideband matched IC. This low current amplifier operates on 3.0 V.

This IC is manufactured using NEC's 30 GHz f_{max} UHS0 (Ultra High Speed Process) silicon bipolar process. This process uses direct silicon nitride passivation film and gold electrodes. These materials can protect the chip surface from pollution and prevent corrosion/migration. Thus, this IC has excellent performance, uniformity and reliability.

FEATURES

- Low current consumption : $I_{CC} = 4.0$ mA TYP. @ $V_{CC} = 3.0$ V
- Supply voltage : $V_{CC} = 2.4$ to 3.3 V
- High efficiency : $P_{O(1\text{ dB})} = +3.0$ dBm TYP. @ $f = 1.0$ GHz
 $P_{O(1\text{ dB})} = +1.5$ dBm TYP. @ $f = 1.9$ GHz
 $P_{O(1\text{ dB})} = +1.0$ dBm TYP. @ $f = 2.4$ GHz
- Power gain : $G_P = 13.5$ dB TYP. @ $f = 1.0$ GHz
 $G_P = 15.5$ dB TYP. @ $f = 1.9$ GHz
 $G_P = 15.5$ dB TYP. @ $f = 2.4$ GHz
- Excellent isolation : $ISL = 44$ dB TYP. @ $f = 1.0$ GHz
 $ISL = 42$ dB TYP. @ $f = 1.9$ GHz
 $ISL = 41$ dB TYP. @ $f = 2.4$ GHz
- Operating frequency : 0.1 to 2.4 GHz (Output port LC matching)
- High-density surface mounting : 6-pin super minimold package (2.0 \times 1.25 \times 0.9 mm)
- Light weight : 7 mg (Standard value)

APPLICATION

- Buffer amplifiers on 0.1 to 2.4 GHz mobile communications system

Caution Electro-static sensitive devices

The information in this document is subject to change without notice. Before using this document, please confirm that this is the latest version.
 Not all devices/types available in every country. Please check with local NEC representative for availability and additional information.

ORDERING INFORMATION

Part Number	Package	Marking	Supplying Form
μPC8179TB-E3	6-pin super minimold	C3C	Embossed tape 8 mm wide. 1, 2, 3 pins face the perforation side of the tape. Qty 3 kpcs/reel.

Remark To order evaluation samples, please contact your local NEC sales office.
(Part number for sample order: μPC8179TB)

PIN CONNECTIONS

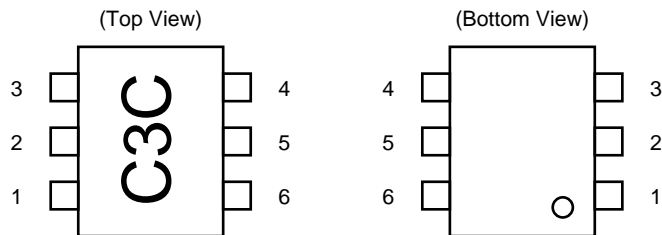

Pin No.	Pin Name
1	INPUT
2	GND
3	GND
4	OUTPUT
5	GND
6	V _{cc}

PRODUCT LINE-UP (T_A = +25 °C, V_{CC} = V_{out} = 3.0 V, Z_S = Z_L = 50 Ω)

Parameter Part No.	I _{CC} (mA)	1.0 GHz output port matching frequency			1.66 GHz output port matching frequency			1.9 GHz output port matching frequency			2.4 GHz output port matching frequency			Marking
		G _P (dB)	ISL (dB)	P _{O(1 dB)} (dBm)	G _P (dB)	ISL (dB)	P _{O(1 dB)} (dBm)	G _P (dB)	ISL (dB)	P _{O(1 dB)} (dBm)	G _P (dB)	ISL (dB)	P _{O(1 dB)} (dBm)	
μPC8178TB	1.9	11	39	-4.0	-	-	-	11.5	40	-7.0	11.5	38	-7.5	C3B
μPC8179TB	4.0	13.5	44	+3.0	-	-	-	15.5	42	+1.5	15.5	41	+1.0	C3C
μPC8128TB	2.8	12.5	39	-4.0	13	39	-4.0	13	37	-4.0	-	-	-	C2P
μPC8151TB	4.2	12.5	38	+2.5	15	36	+1.5	15	34	+0.5	-	-	-	C2U
μPC8152TB	5.6	23	40	-4.5	19.5	38	-8.5	17.5	35	-8.5	-	-	-	C2V

Remark Typical performance. Please refer to ELECTRICAL CHARACTERISTICS in detail.

SYSTEM APPLICATION EXAMPLE

Location examples in digital cellular

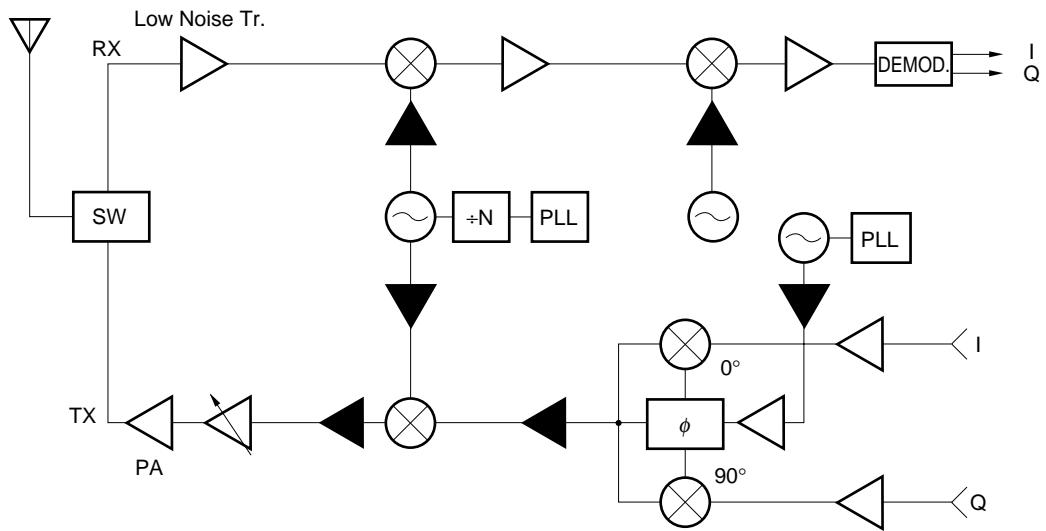

These ICs can be added to your system around ▲ parts, when you need more isolation or gain. The application herein, however, shows only examples, therefore the application can depend on your kit evaluation.

PIN EXPLANATION

Pin No.	Pin Name	Applied Voltage (V)	Pin Voltage (V) ^{Note}	Function and Applications	Internal Equivalent Circuit
1	INPUT	–	1.09	Signal input pin. A internal matching circuit, configured with resistors, enables 50 Ω connection over a wide band. This pin must be coupled to signal source with capacitor for DC cut.	
2 3 5	GND	0	–	Ground pin. This pin should be connected to system ground with minimum inductance. Ground pattern on the board should be formed as wide as possible. All the ground pins must be connected together with wide ground pattern to decrease impedance difference.	
4	OUTPUT	voltage as same as V _{CC} through external inductor	–	Signal output pin. This pin is designed as collector output. Due to the high impedance output, this pin should be externally equipped with LC matching circuit to next stage. For L, a size 1005 chip inductor can be chosen.	
6	V _{CC}	2.4 to 3.3	–	Power supply pin. This pin should be externally equipped with bypass capacitor to minimize its impedance.	

Note Pin voltage is measured at V_{CC} = 3.0 V.

ABSOLUTE MAXIMUM RATINGS

Parameter	Symbol	Conditions	Ratings	Unit
Supply Voltage	V _{CC}	T _A = +25 °C, Pin 4, Pin 6	3.6	V
Circuit Current	I _{CC}	T _A = +25 °C	15	mA
Power Dissipation	P _D	Mounted on double sided copper clad 50 × 50 × 1.6 mm epoxy glass PWB (T _A = +85 °C)	270	mW
Operating Ambient Temperature	T _A		-40 to +85	°C
Storage Temperature	T _{stg}		-55 to +150	°C
Input Power	P _{in}	T _A = +25 °C	+5	dBm

RECOMMENDED OPERATING CONDITIONS

Parameter	Symbol	MIN.	TYP.	MAX.	Unit	Remarks
Supply Voltage	V _{CC}	2.4	3.0	3.3	V	The same voltage should be applied to pin 4 and pin 6.
Operating Ambient Temperature	T _A	-40	+25	+85	°C	

ELECTRICAL CHARACTERISTICS

(Unless otherwise specified, T_A = +25 °C, V_{CC} = V_{out} = 3.0 V, Z_s = Z_L = 50 Ω, at LC matched frequency)

Parameter	Symbol	Conditions	MIN.	TYP.	MAX.	Unit
Circuit Current	I _{CC}	No signal	2.9	4.0	5.4	mA
Power Gain	G _P	f = 1.0 GHz, P _{in} = -30 dBm f = 1.9 GHz, P _{in} = -30 dBm f = 2.4 GHz, P _{in} = -30 dBm	11.0 13.0 13.0	13.5 15.5 15.5	15.5 17.5 17.5	dB
Isolation	ISL	f = 1.0 GHz, P _{in} = -30 dBm f = 1.9 GHz, P _{in} = -30 dBm f = 2.4 GHz, P _{in} = -30 dBm	39 37 36	44 42 41	- - -	dB
1 dB Gain Compression Output Power	P _{O(1dB)}	f = 1.0 GHz f = 1.9 GHz f = 2.4 GHz	-0.5 -2.0 -3.0	+3.0 +1.5 +1.0	- - -	dBm
Noise Figure	NF	f = 1.0 GHz f = 1.9 GHz f = 2.4 GHz	- - -	5.0 5.0 5.0	6.5 6.5 6.5	dB
Input Return Loss (Without matching circuit)	RL _{in}	f = 1.0 GHz, P _{in} = -30 dBm f = 1.9 GHz, P _{in} = -30 dBm f = 2.4 GHz, P _{in} = -30 dBm	4 4 6	7 7 9	- - -	dB

TEST CIRCUITS

<1> $f = 1.0 \text{ GHz}$

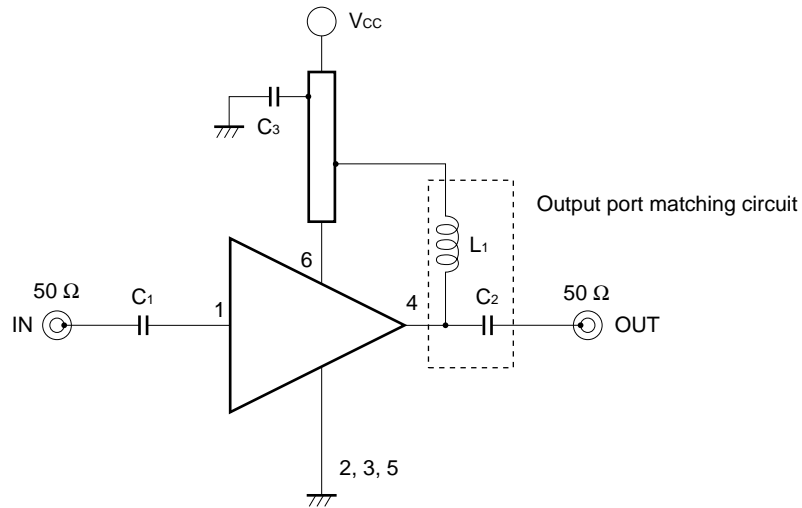

<2> $f = 1.9 \text{ GHz}$

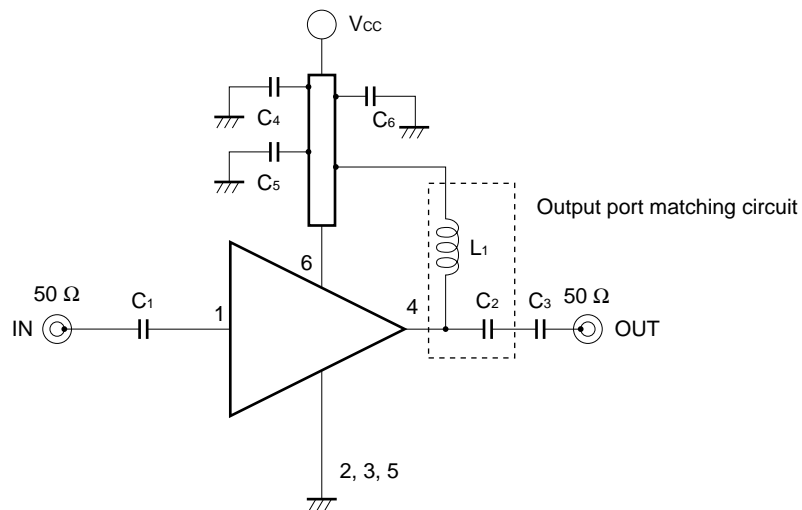

<3> $f = 2.4 \text{ GHz}$

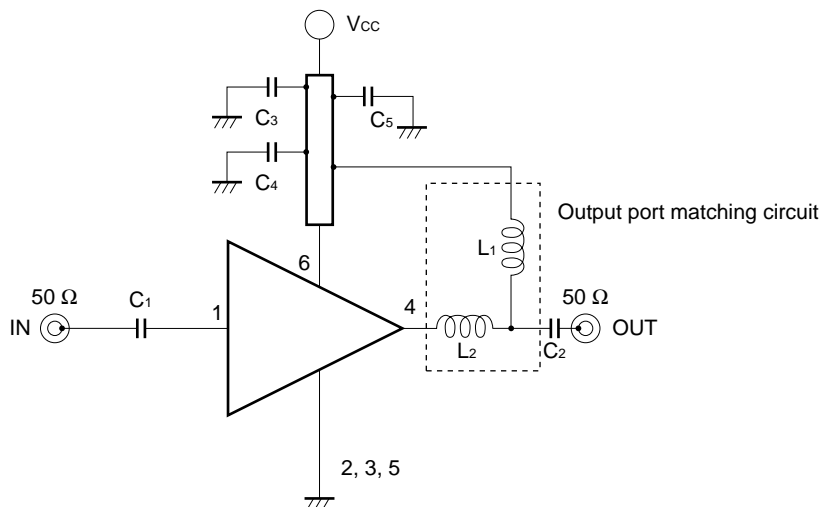
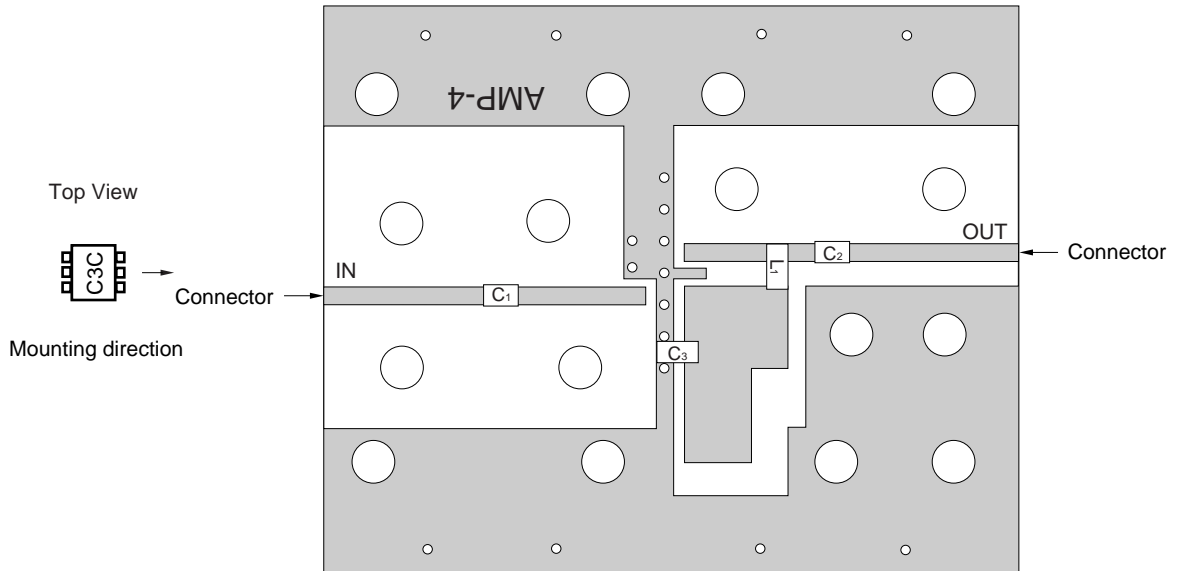

ILLUSTRATION OF THE TEST CIRCUIT ASSEMBLED ON EVALUATION BOARD

<1> $f = 1.0 \text{ GHz}$



COMPONENT LIST

1.0 GHz Output Port Matching	
C ₁	1 000 pF
C ₂	0.75 pF
C ₃	10 pF
L ₁	12 nH

<2> f = 1.9 GHz

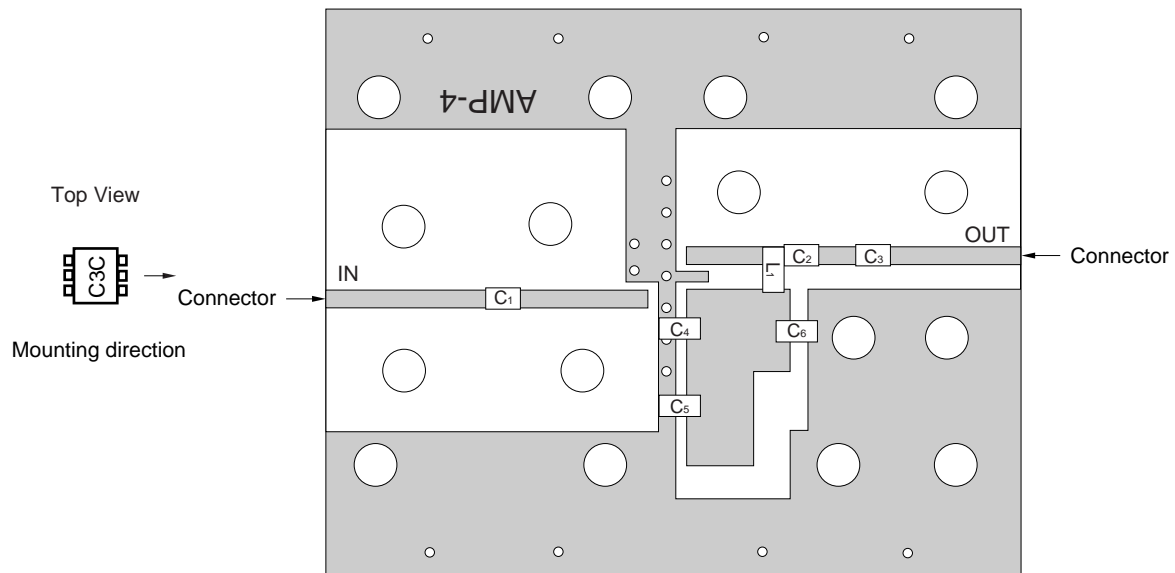

COMPONENT LIST

1.9 GHz Output Port Matching	
C1, C3, C5, C6	1 000 pF
C2	0.75 pF
C4	10 pF
L1	3.3 nH

<3> f = 2.4 GHz

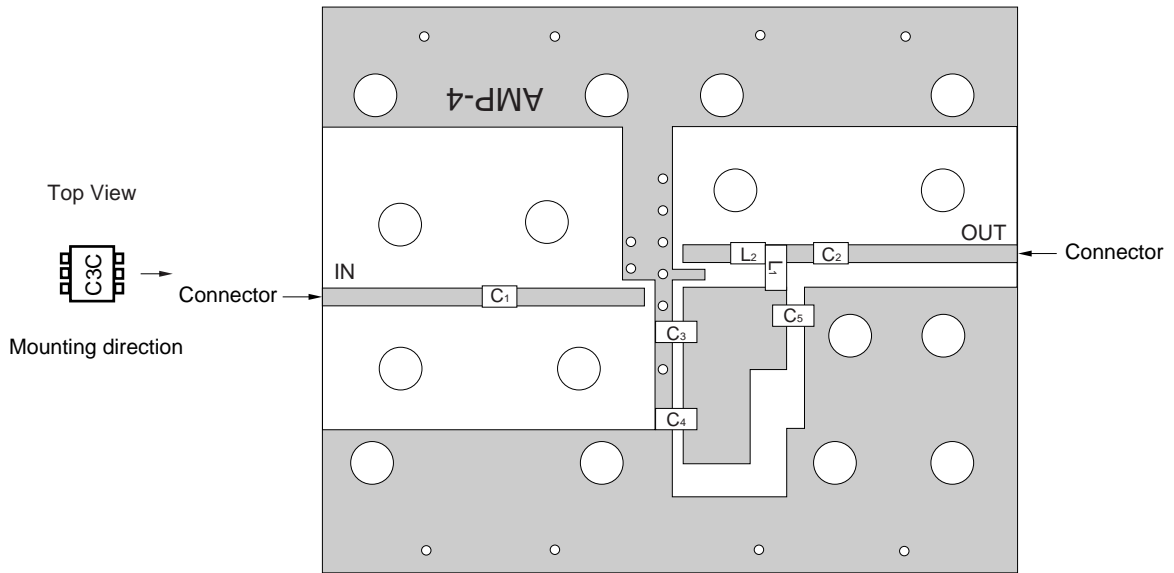

COMPONENT LIST

2.4 GHz Output Port Matching	
C ₁ , C ₂ , C ₄ , C ₅	1 000 pF
C ₃	10 pF
L ₁	1.8 nH
L ₂	2.7 nH

NOTES

- (*1) 42 × 35 × 0.4 mm double sided copper clad polyimide board
- (*2) Solder plated on pattern
- (*3) Back side: GND pattern
- (*4) ○: Through holes

TYPICAL CHARACTERISTICS (unless otherwise specified, T_A = +25°C)

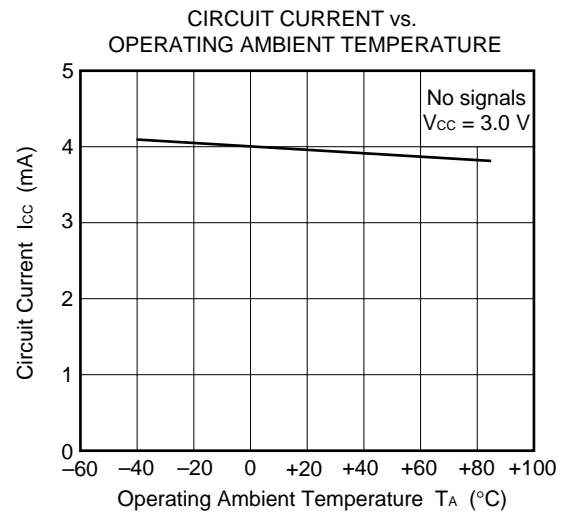
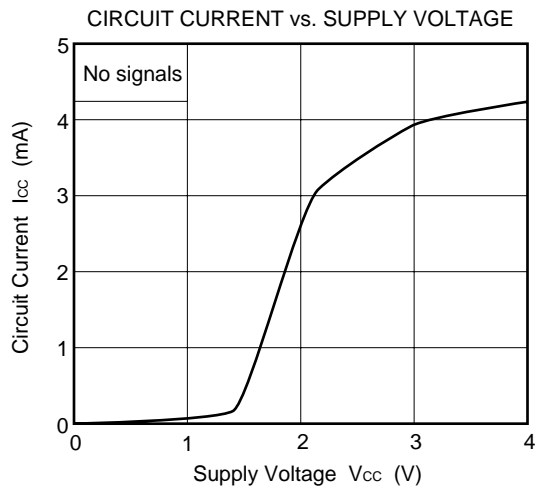

1.0 GHz OUTPUT PORT MATCHING

S-PARAMETER (monitored at connector on board)

T_A = +25°C, V_{CC} = V_{out} = 3.0 V

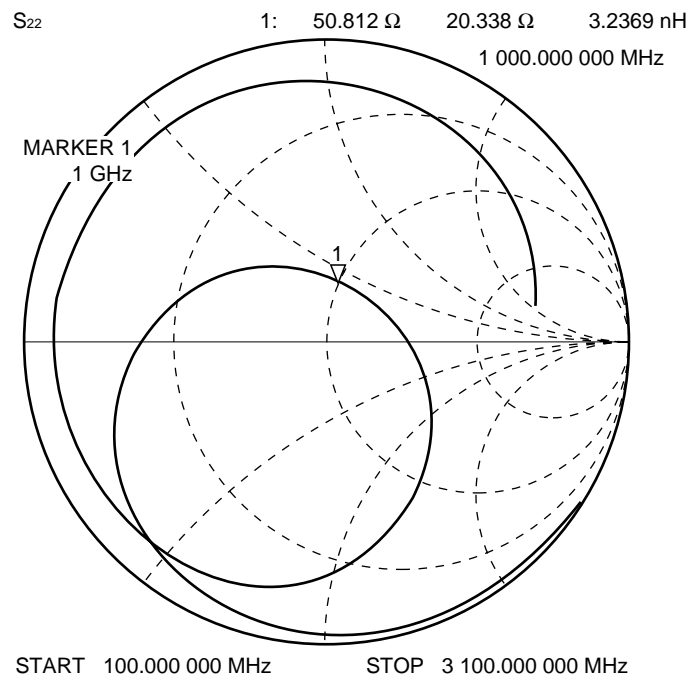
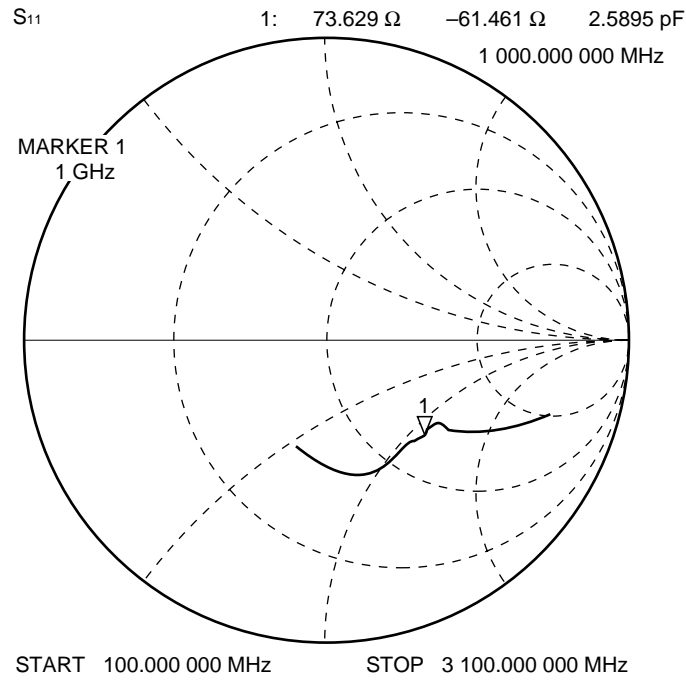

1.0 GHz OUTPUT PORT MATCHING

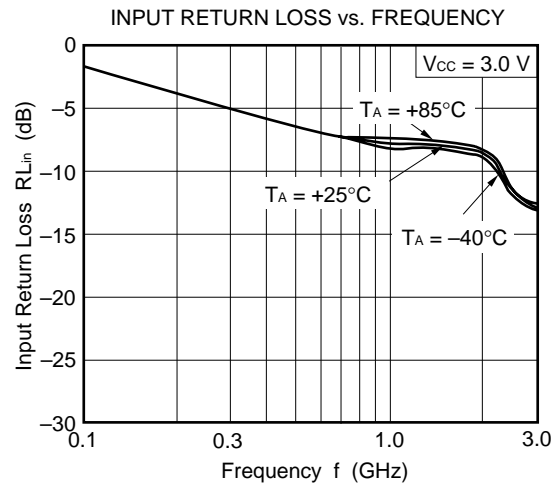
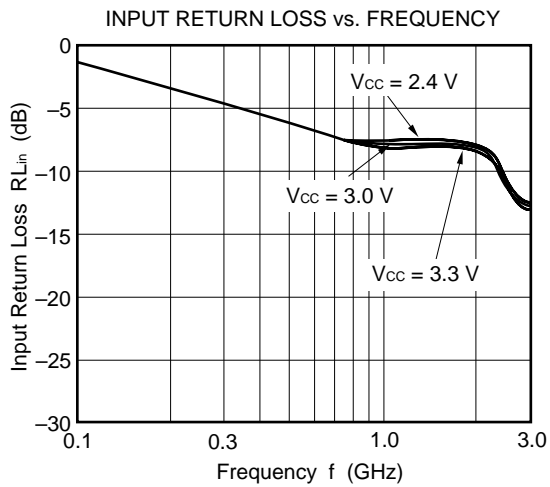
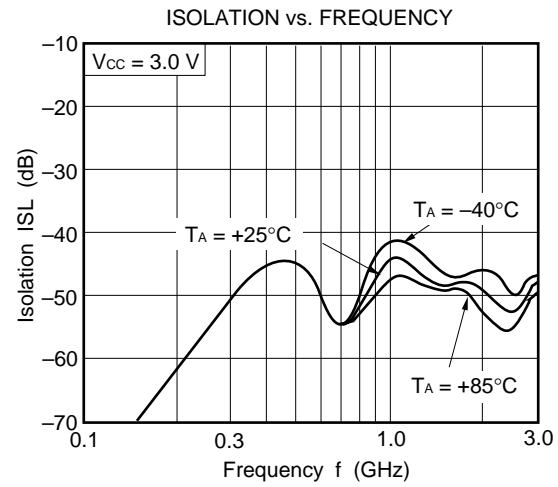
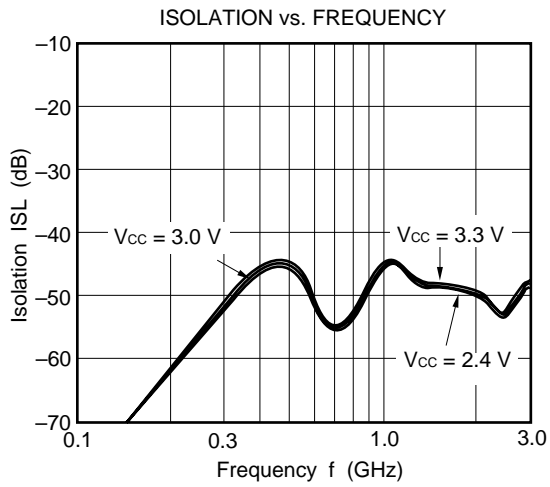
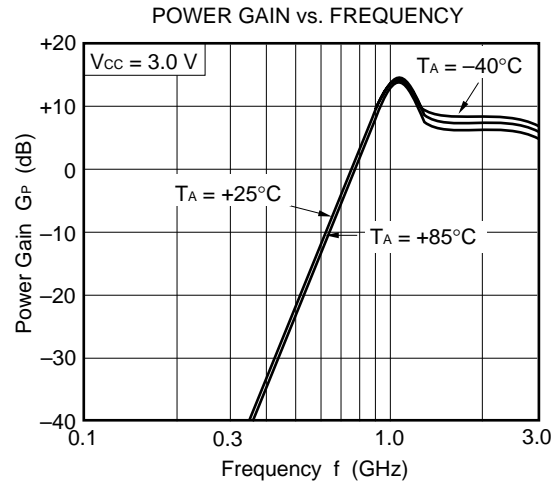
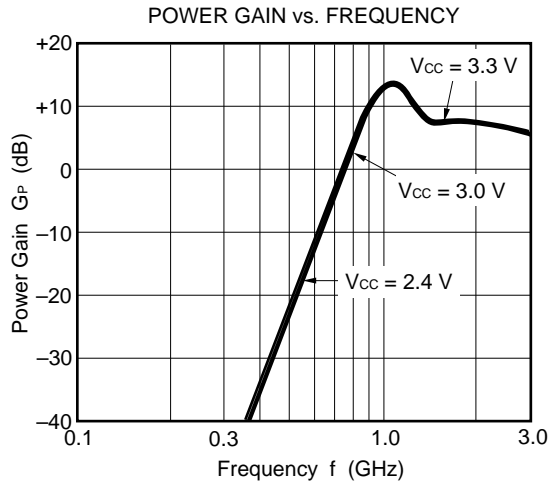

1.0 GHz OUTPUT PORT MATCHING

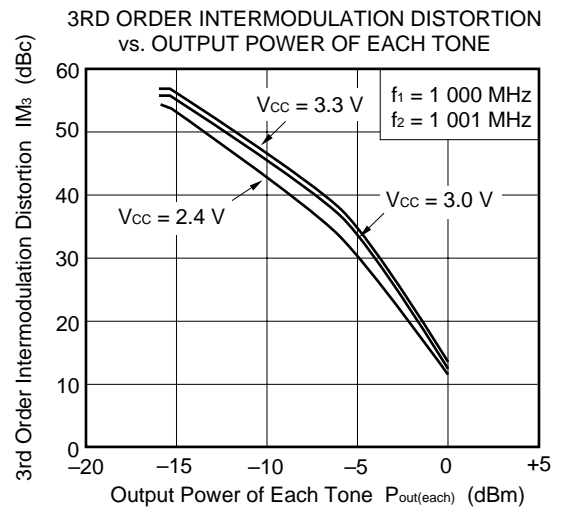
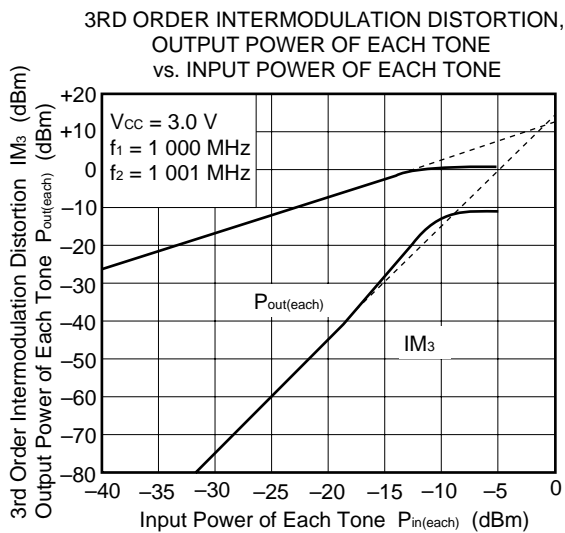
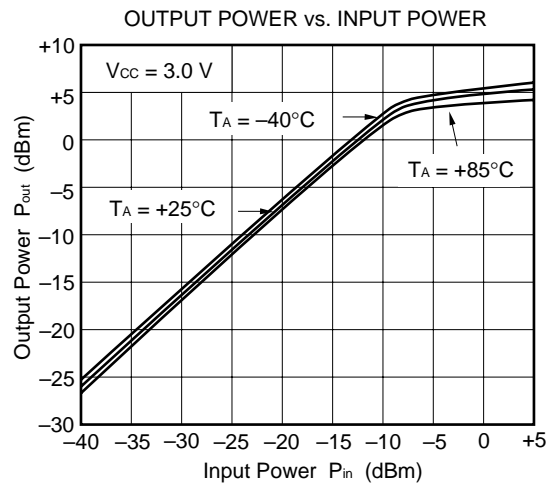
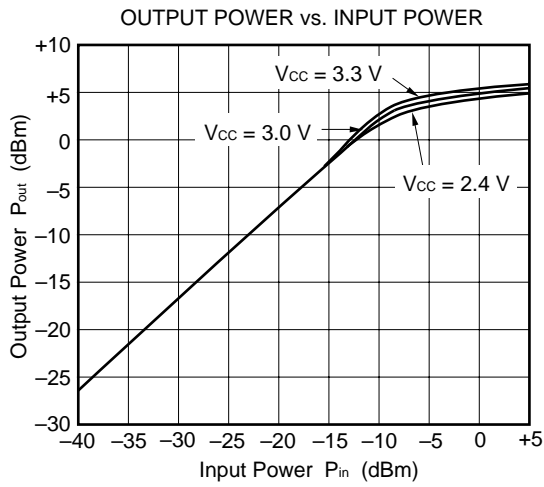
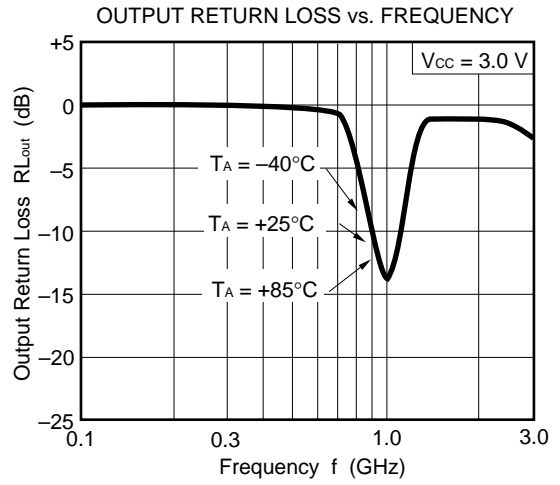
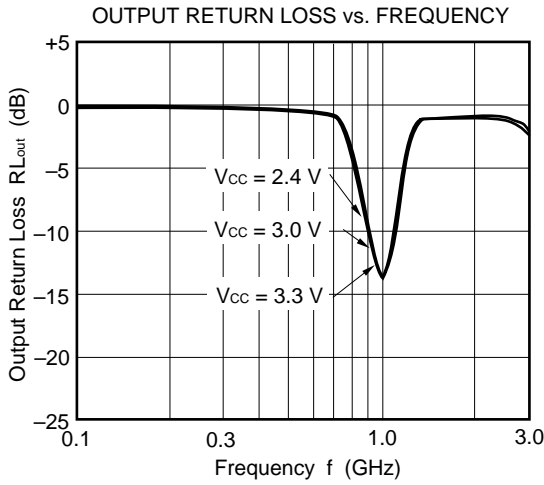

1.0 GHz OUTPUT PORT MATCHING

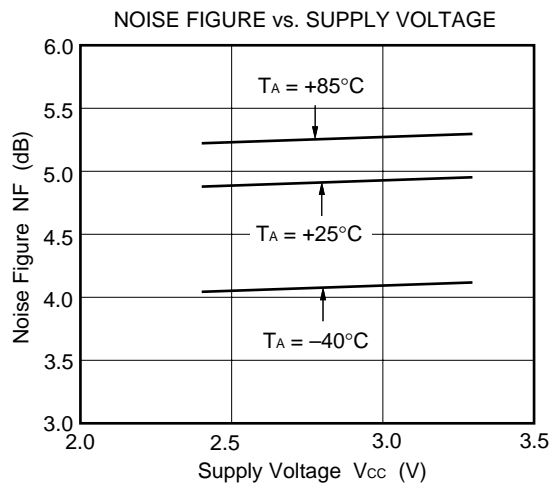

1.9 GHz OUTPUT PORT MATCHING

S-PARAMETER (monitored at connector on board)

$T_A = +25^\circ\text{C}$, $V_{CC} = V_{out} = 3.0\text{ V}$

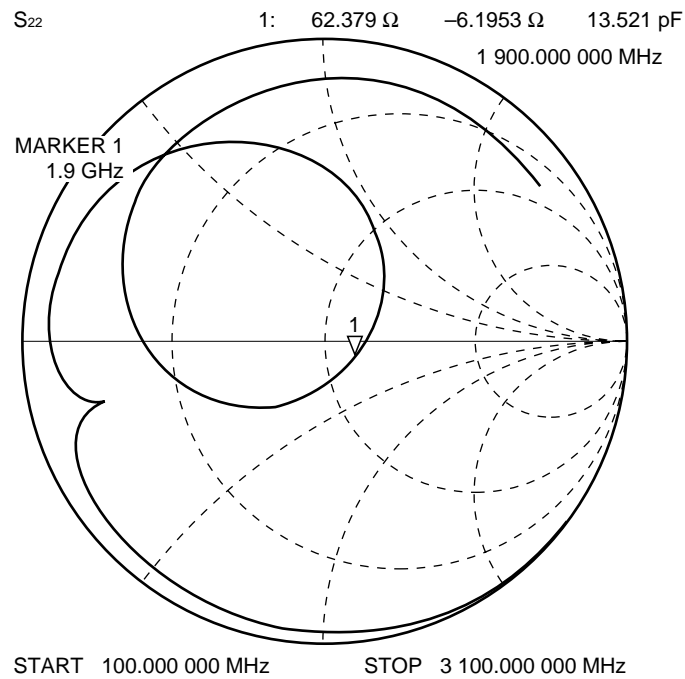
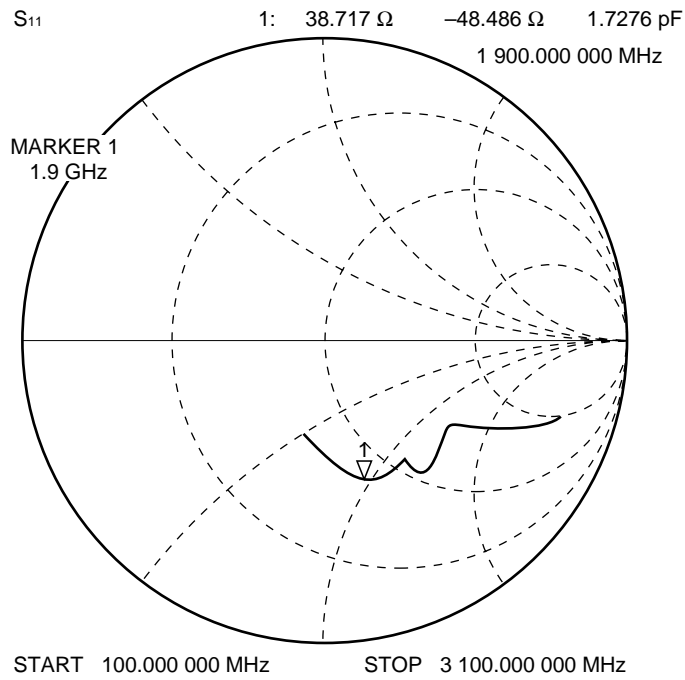

1.9 GHz OUTPUT PORT MATCHING

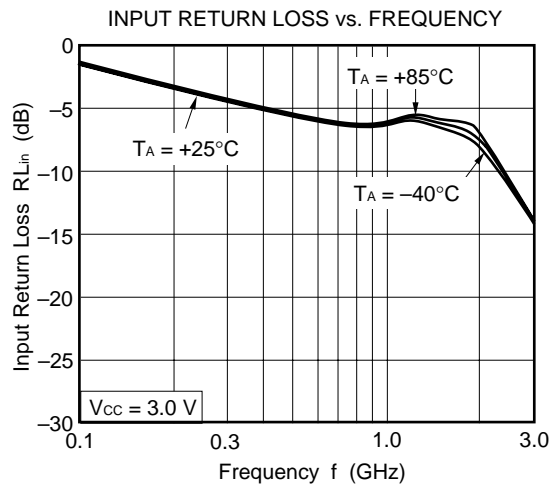
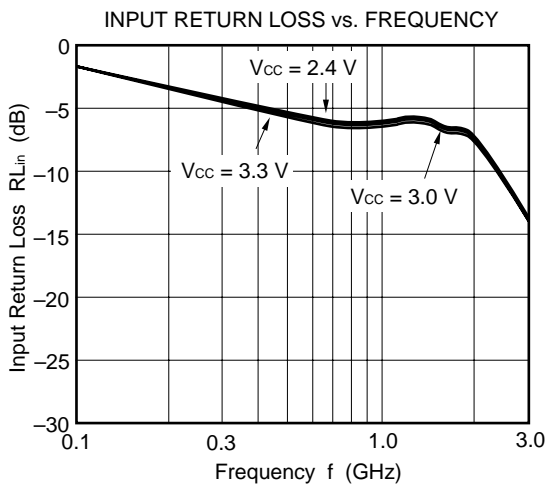
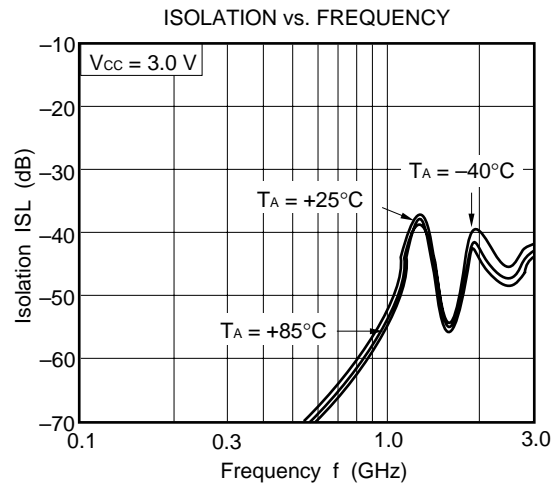
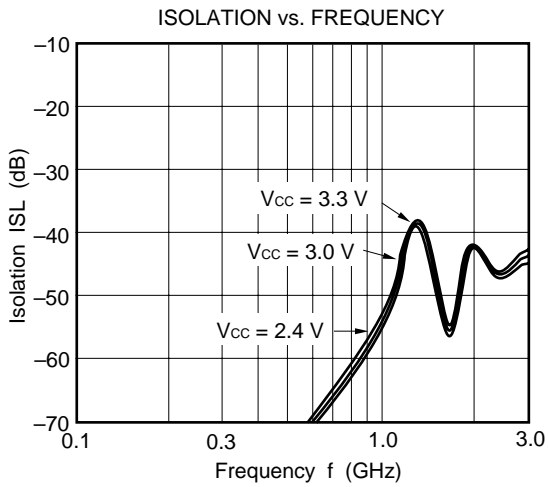
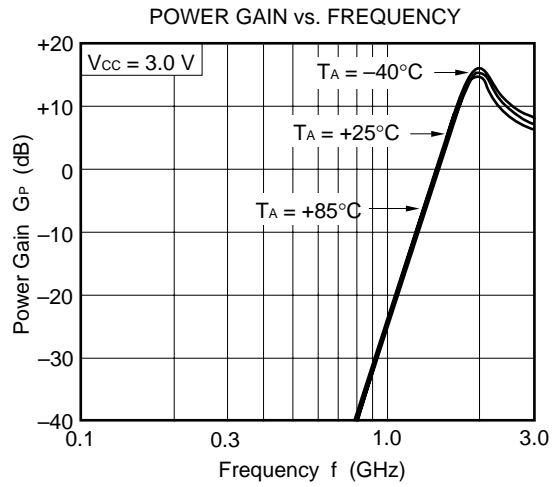
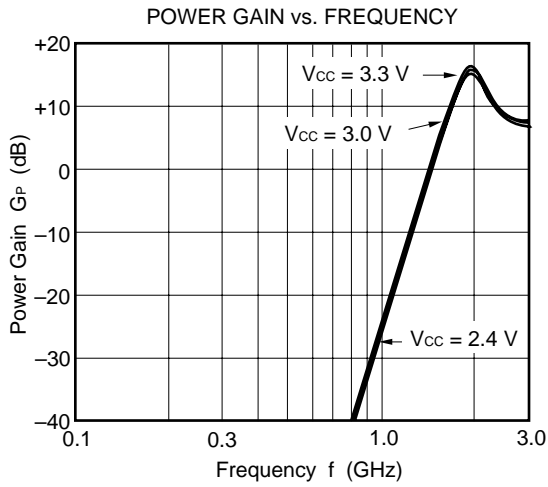

1.9 GHz OUTPUT PORT MATCHING

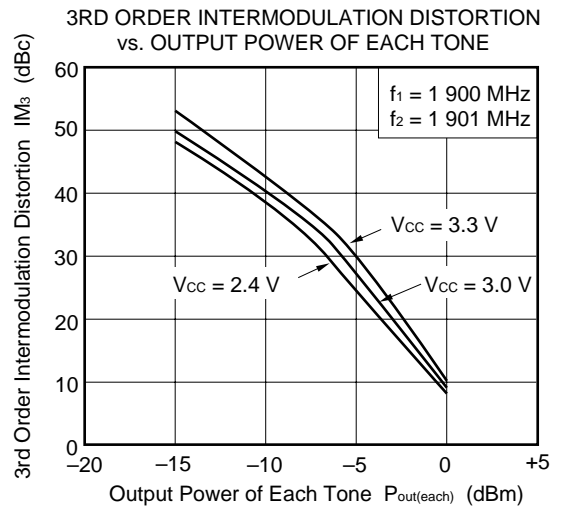
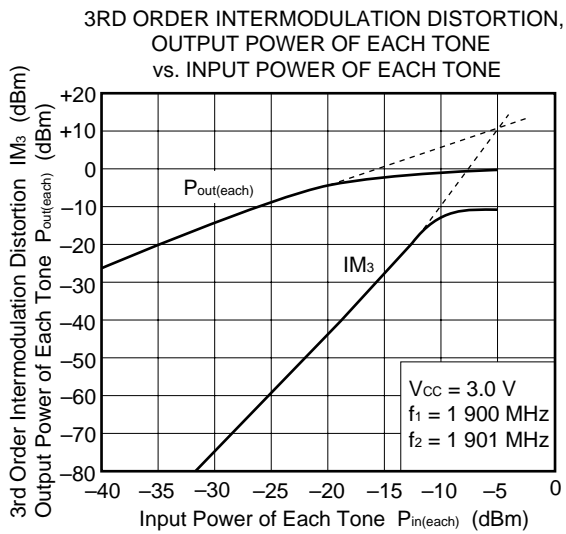
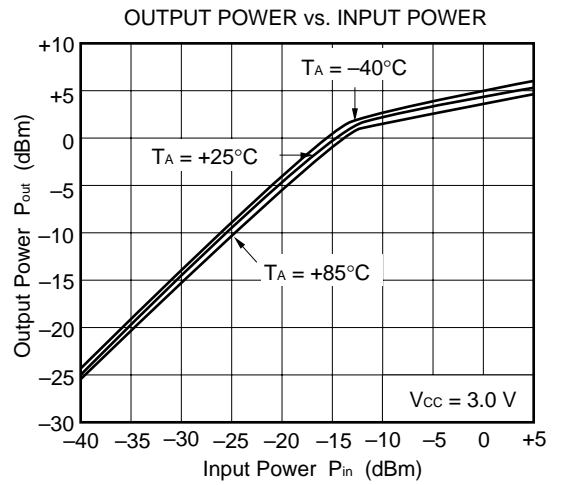
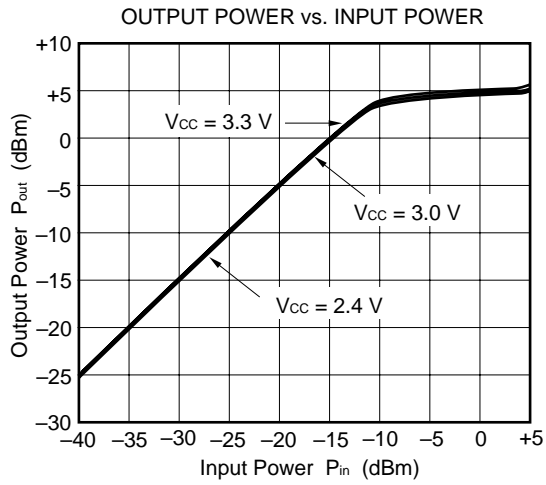
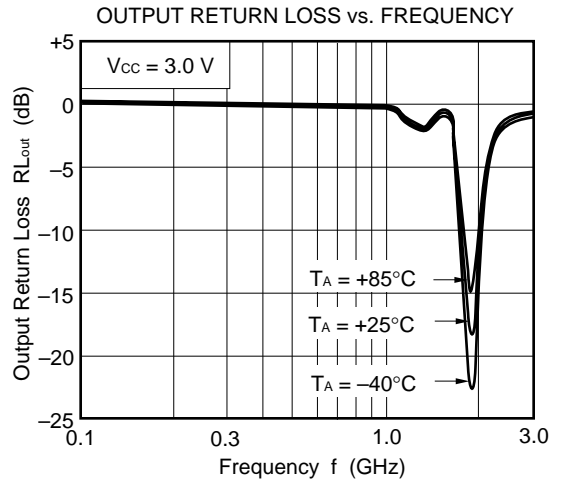
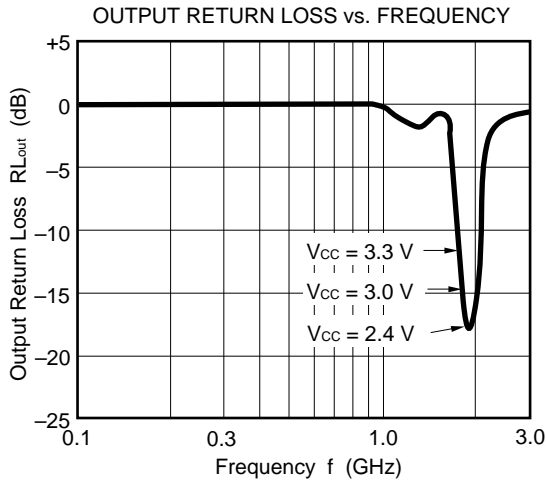

1.9 GHz OUTPUT PORT MATCHING

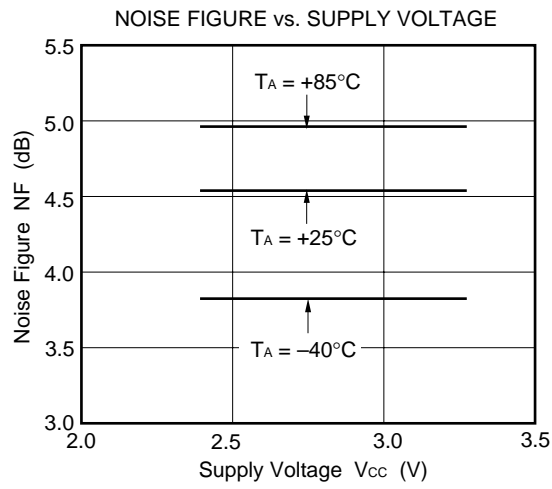

2.4 GHz OUTPUT PORT MATCHING

S-PARAMETER (monitored at connector on board)

$T_A = +25^\circ\text{C}$, $V_{CC} = V_{out} = 3.0\text{ V}$

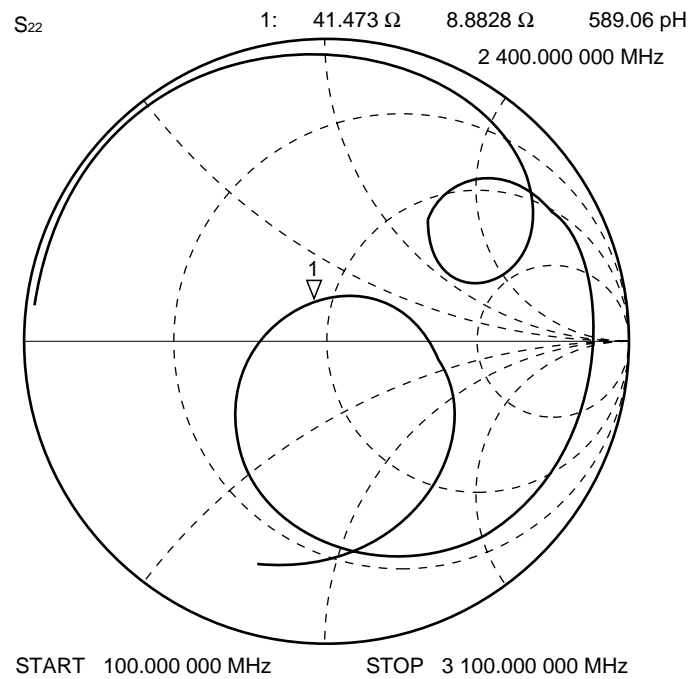
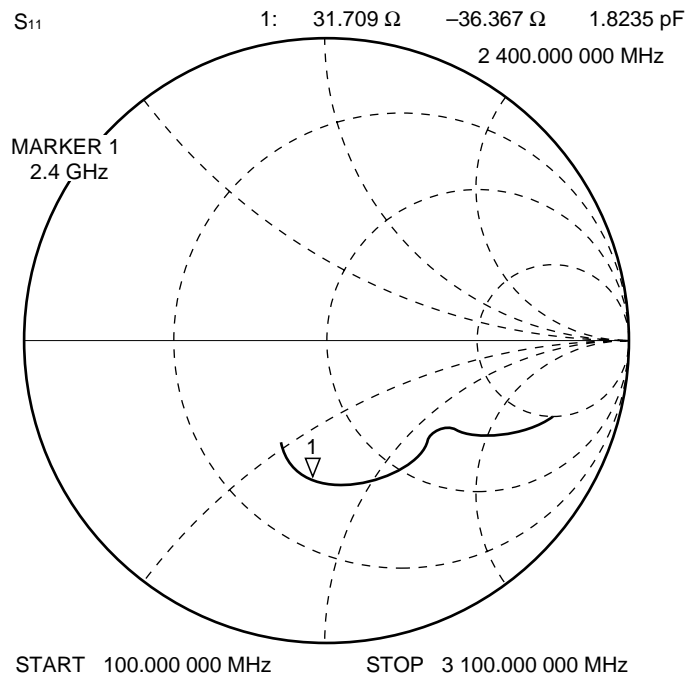

2.4 GHz OUTPUT PORT MATCHING

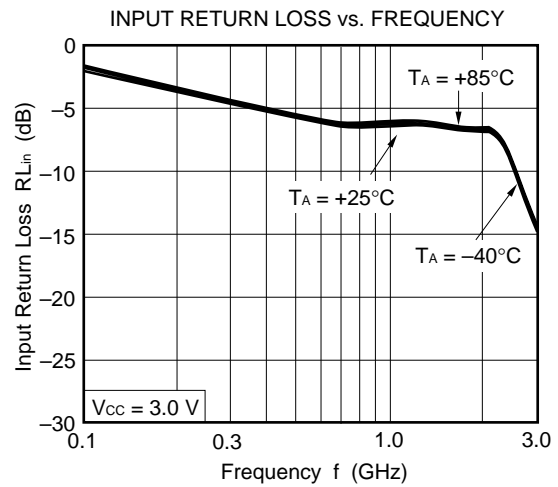
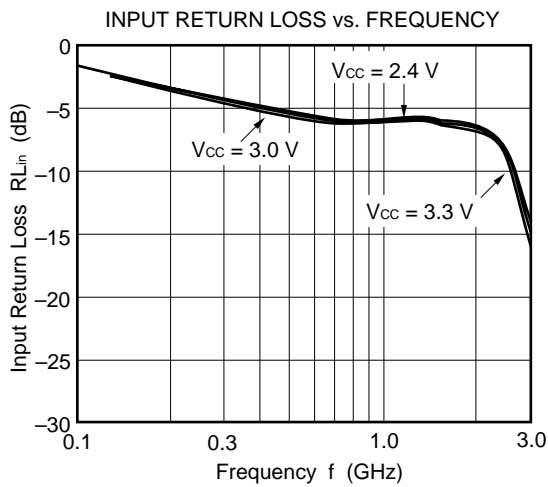
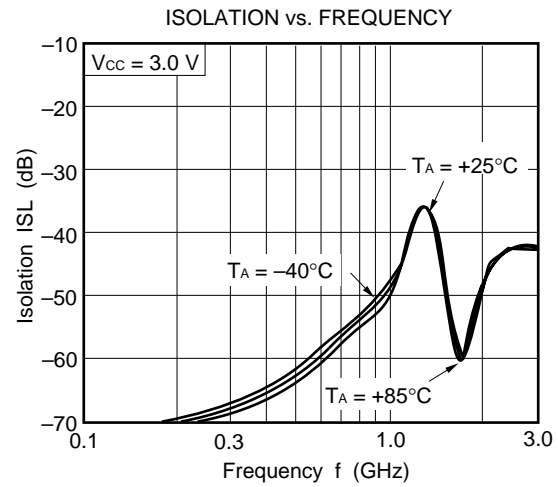
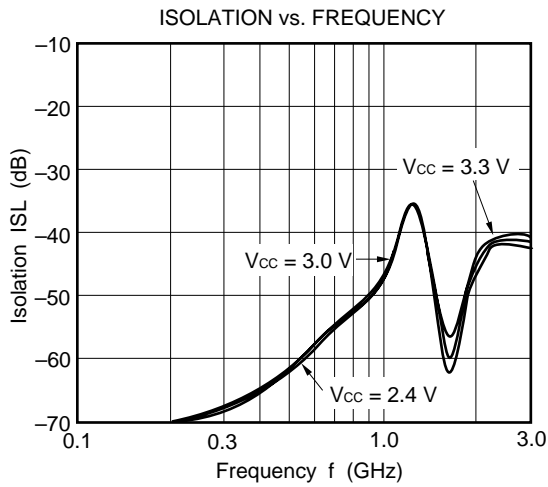
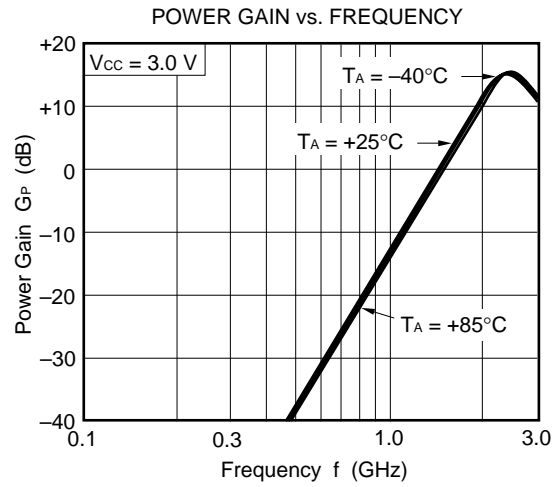
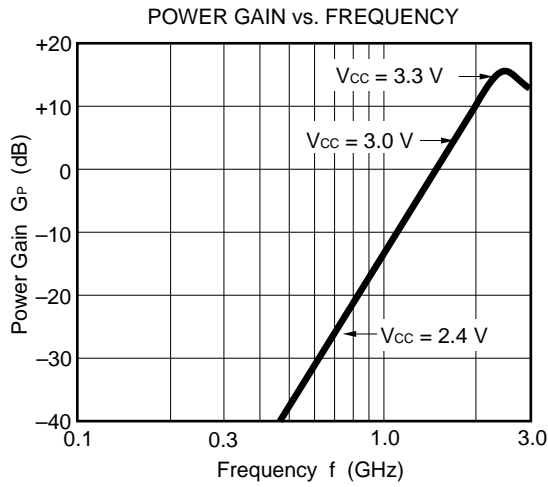

2.4 GHz OUTPUT PORT MATCHING

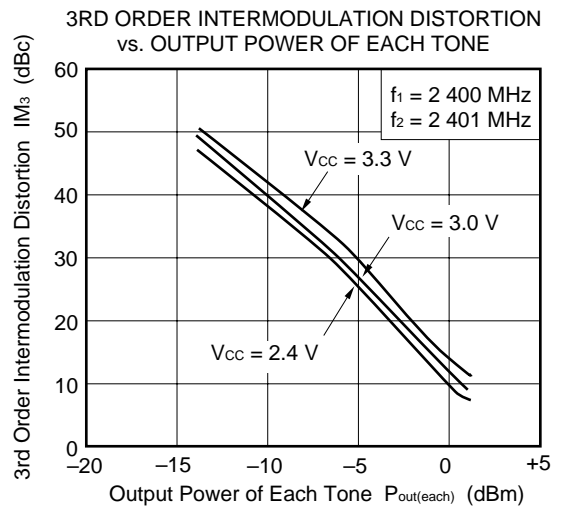
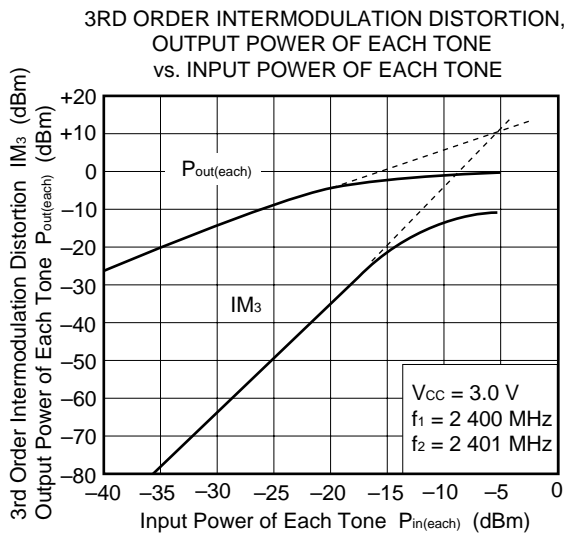
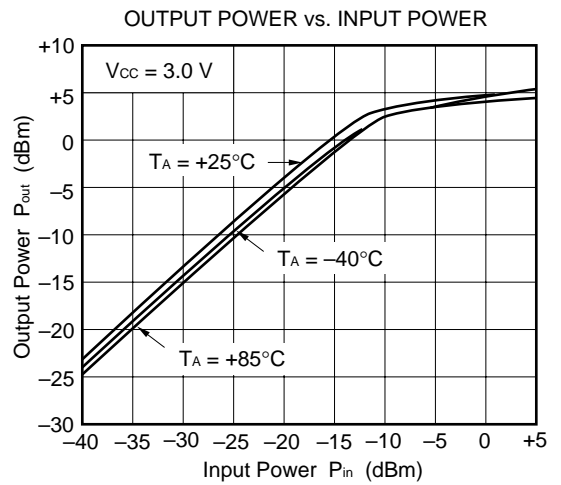
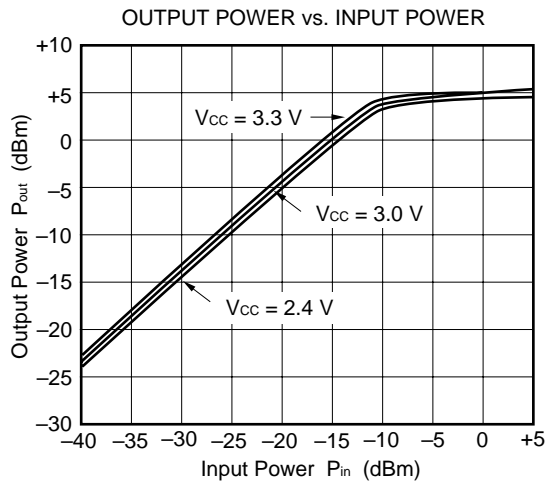
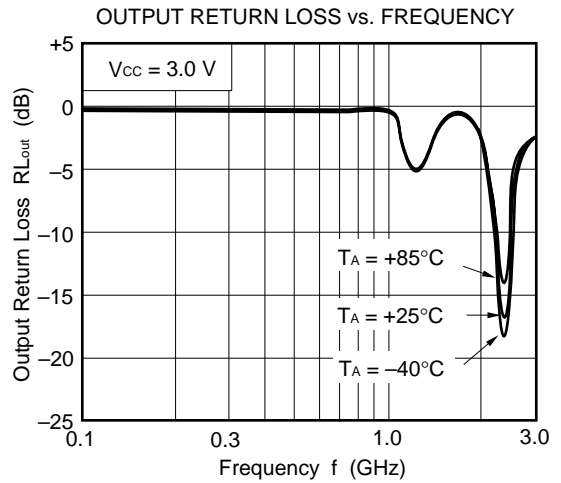
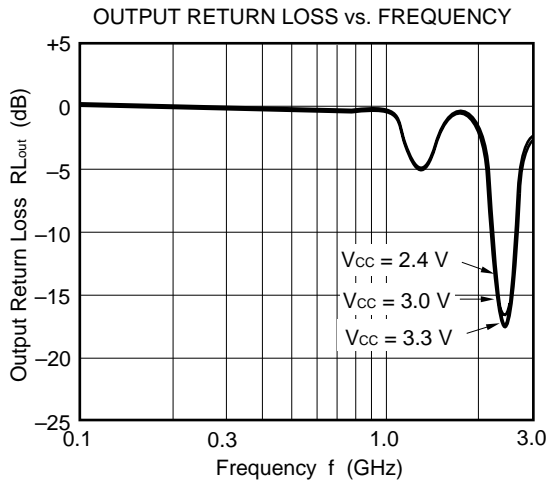

2.4 GHz OUTPUT PORT MATCHING

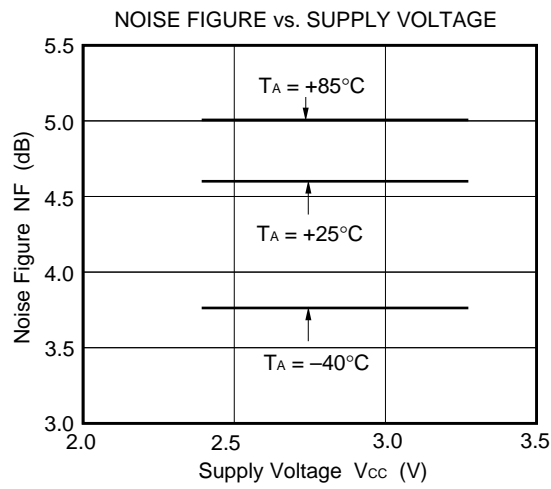

Remark The graphs indicate nominal characteristics.

S-PARAMETER ($V_{CC} = V_{out} = 3.0\text{ V}$)

S₁₁-FREQUENCY

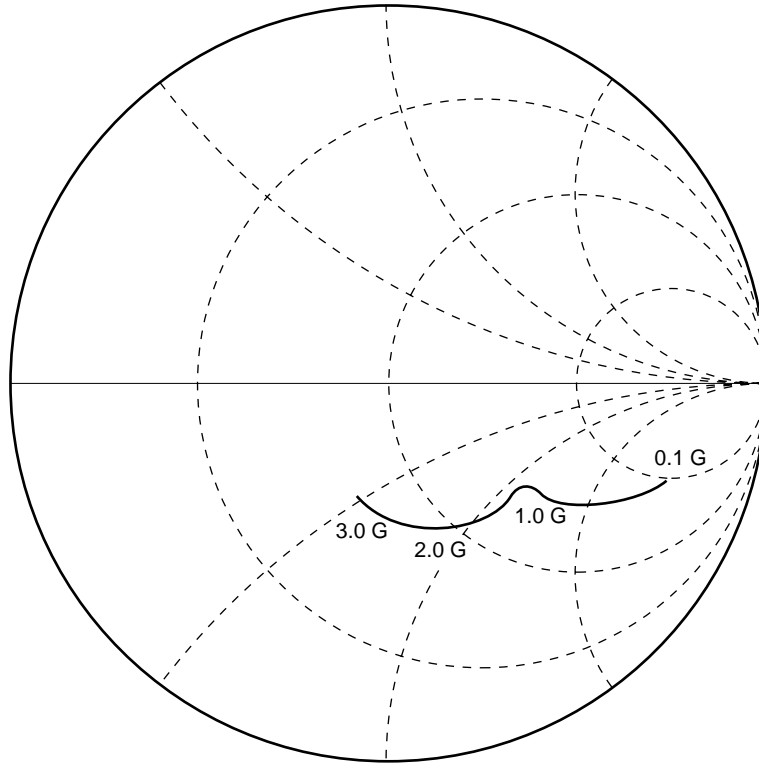

S₂₂-FREQUENCY

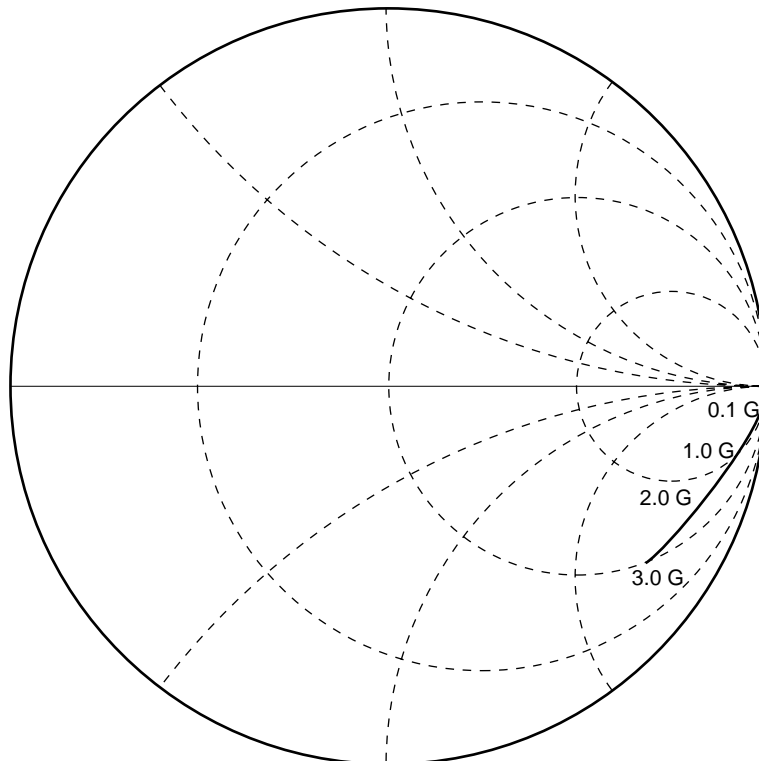

TYPICAL S-PARAMETER VALUES (T_A = +25°C)

V_{CC} = V_{out} = 3.0 V, I_{CC} = 4.0 mA

FREQUENCY MHz	S ₁₁		S ₂₁		S ₁₂		S ₂₂	
	MAG.	ANG.	MAG.	ANG.	MAG.	ANG.	MAG.	ANG.
100.0000	0.824	-17.1	1.181	-177.7	0.002	108.8	0.996	-2.4
200.0000	0.692	-25.9	1.181	-172.4	0.003	64.7	0.986	-4.0
300.0000	0.594	-29.2	1.247	-167.4	0.004	51.3	0.980	-5.8
400.0000	0.533	-30.7	1.370	-164.1	0.005	55.8	0.965	-7.5
500.0000	0.499	-31.1	1.514	-162.4	0.005	60.6	0.958	-8.6
600.0000	0.474	-32.0	1.677	-162.9	0.006	46.6	0.950	-10.1
700.0000	0.460	-32.7	1.885	-163.8	0.006	42.9	0.941	-11.2
800.0000	0.450	-34.0	2.050	-166.3	0.006	45.9	0.935	-12.4
900.0000	0.441	-35.6	2.237	-169.2	0.005	42.1	0.929	-13.8
1000.0000	0.438	-37.7	2.460	-173.1	0.007	34.0	0.918	-14.9
1100.0000	0.431	-39.8	2.627	-177.3	0.007	46.9	0.914	-16.0
1200.0000	0.426	-42.0	2.772	178.4	0.005	27.7	0.903	-17.0
1300.0000	0.427	-44.8	2.965	173.2	0.005	40.2	0.895	-18.3
1400.0000	0.417	-48.1	3.123	168.0	0.004	24.4	0.891	-19.5
1500.0000	0.413	-50.6	3.199	161.8	0.006	45.5	0.884	-20.4
1600.0000	0.408	-54.6	3.351	156.8	0.005	44.6	0.877	-21.1
1700.0000	0.398	-57.6	3.345	151.2	0.003	42.4	0.867	-22.1
1800.0000	0.387	-61.6	3.403	145.5	0.005	42.7	0.861	-23.0
1900.0000	0.380	-64.9	3.361	140.9	0.005	59.5	0.859	-24.4
2000.0000	0.366	-69.1	3.375	136.3	0.004	45.4	0.852	-25.1
2100.0000	0.352	-72.1	3.350	132.3	0.003	58.3	0.846	-25.9
2200.0000	0.341	-75.6	3.304	127.9	0.003	73.9	0.847	-26.4
2300.0000	0.330	-79.4	3.347	124.8	0.006	81.1	0.839	-27.4
2400.0000	0.320	-82.4	3.325	121.2	0.006	98.3	0.839	-28.2
2500.0000	0.304	-85.6	3.275	117.3	0.006	100.5	0.838	-29.1
2600.0000	0.296	-88.2	3.284	113.7	0.004	114.6	0.834	-29.7
2700.0000	0.285	-91.7	3.283	111.0	0.005	104.8	0.830	-30.6
2800.0000	0.272	-94.3	3.224	106.5	0.005	114.1	0.831	-31.4
2900.0000	0.267	-96.9	3.333	104.3	0.008	127.8	0.837	-32.0
3000.0000	0.256	-99.5	3.251	101.1	0.009	126.3	0.831	-33.4
3100.0000	0.248	-101.9	3.381	96.0	0.008	134.1	0.833	-34.0

PACKAGE DIMENSIONS

6 PIN SUPER MINIMOLD (UNIT: mm)

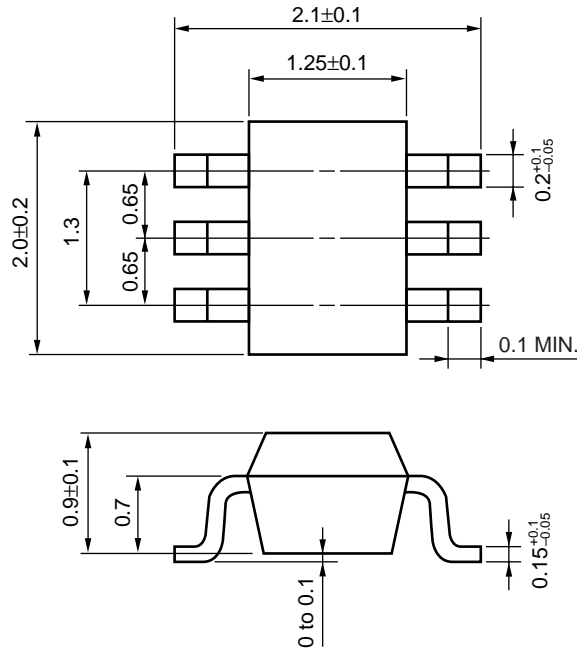

NOTES ON CORRECT USE

- (1) Observe precautions for handling because of electro-static sensitive devices.
- (2) Form a ground pattern as widely as possible to minimize ground impedance (to prevent undesired oscillation). All the ground pins must be connected together with wide ground pattern to decrease impedance difference.
- (3) The bypass capacitor should be attached to Vcc line.
- (4) The inductor (L) should be attached between output and Vcc pins. The L and series capacitor (C) values should be adjusted for applied frequency to match impedance to next stage.
- (5) The DC capacitor must be attached to input pin.

RECOMMENDED SOLDERING CONDITIONS

This product should be soldered under the following recommended conditions. For soldering methods and conditions other than those recommended below, contact your NEC sales representative.

Soldering Method	Soldering Conditions	Recommended Condition Symbol
Infrared Reflow	Package peak temperature: 235°C or below Time: 30 seconds or less (at 210°C) Count: 3, Exposure limit: None ^{Note}	IR35-00-3
VPS	Package peak temperature: 215°C or below Time: 40 seconds or less (at 200°C) Count: 3, Exposure limit: None ^{Note}	VP15-00-3
Wave Soldering	Soldering bath temperature: 260°C or below Time: 10 seconds or less Count: 1, Exposure limit: None ^{Note}	WS60-00-1
Partial Heating	Pin temperature: 300°C Time: 3 seconds or less (per side of device) Exposure limit: None ^{Note}	—

Note After opening the dry pack, keep it in a place below 25°C and 65% RH for the allowable storage period.

Caution Do not use different soldering methods together (except for partial heating).

For details of recommended soldering conditions for surface mounting, refer to information document **SEMICONDUCTOR DEVICE MOUNTING TECHNOLOGY MANUAL (C10535E)**.

[MEMO]

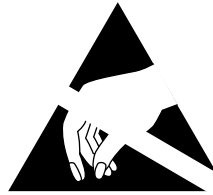

ATTENTION

OBSERVE PRECAUTIONS
FOR HANDLING
ELECTROSTATIC
SENSITIVE
DEVICES

- **The information in this document is current as of August, 2000. The information is subject to change without notice. For actual design-in, refer to the latest publications of NEC's data sheets or data books, etc., for the most up-to-date specifications of NEC semiconductor products. Not all products and/or types are available in every country. Please check with an NEC sales representative for availability and additional information.**
- No part of this document may be copied or reproduced in any form or by any means without prior written consent of NEC. NEC assumes no responsibility for any errors that may appear in this document.
- NEC does not assume any liability for infringement of patents, copyrights or other intellectual property rights of third parties by or arising from the use of NEC semiconductor products listed in this document or any other liability arising from the use of such products. No license, express, implied or otherwise, is granted under any patents, copyrights or other intellectual property rights of NEC or others.
- Descriptions of circuits, software and other related information in this document are provided for illustrative purposes in semiconductor product operation and application examples. The incorporation of these circuits, software and information in the design of customer's equipment shall be done under the full responsibility of customer. NEC assumes no responsibility for any losses incurred by customers or third parties arising from the use of these circuits, software and information.
- While NEC endeavours to enhance the quality, reliability and safety of NEC semiconductor products, customers agree and acknowledge that the possibility of defects thereof cannot be eliminated entirely. To minimize risks of damage to property or injury (including death) to persons arising from defects in NEC semiconductor products, customers must incorporate sufficient safety measures in their design, such as redundancy, fire-containment, and anti-failure features.
- NEC semiconductor products are classified into the following three quality grades:
 "Standard", "Special" and "Specific". The "Specific" quality grade applies only to semiconductor products developed based on a customer-designated "quality assurance program" for a specific application. The recommended applications of a semiconductor product depend on its quality grade, as indicated below. Customers must check the quality grade of each semiconductor product before using it in a particular application.
 - "Standard": Computers, office equipment, communications equipment, test and measurement equipment, audio and visual equipment, home electronic appliances, machine tools, personal electronic equipment and industrial robots
 - "Special": Transportation equipment (automobiles, trains, ships, etc.), traffic control systems, anti-disaster systems, anti-crime systems, safety equipment and medical equipment (not specifically designed for life support)
 - "Specific": Aircraft, aerospace equipment, submersible repeaters, nuclear reactor control systems, life support systems and medical equipment for life support, etc.

The quality grade of NEC semiconductor products is "Standard" unless otherwise expressly specified in NEC's data sheets or data books, etc. If customers wish to use NEC semiconductor products in applications not intended by NEC, they must contact an NEC sales representative in advance to determine NEC's willingness to support a given application.

(Note)

- (1) "NEC" as used in this statement means NEC Corporation and also includes its majority-owned subsidiaries.
- (2) "NEC semiconductor products" means any semiconductor product developed or manufactured by or for NEC (as defined above).