



APT5010B2VFR

500V 47A 0.100Ω

POWER MOS V[®]

FREDFET

Power MOS V[®] is a new generation of high voltage N-Channel enhancement mode power MOSFETs. This new technology minimizes the JFET effect, increases packing density and reduces the on-resistance. Power MOS V[®] also achieves faster switching speeds through optimized gate layout.

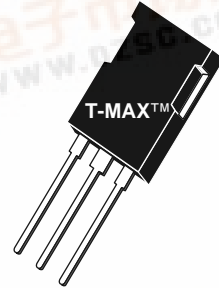

- Fast Recovery Body Diode
- Lower Leakage
- Faster Switching
- 100% Avalanche Tested
- New T-MAX[™] Package (Clip-mounted TO-247 Package)

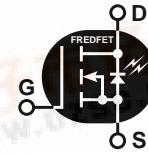

MAXIMUM RATINGS

All Ratings: T_C = 25°C unless otherwise specified.

Symbol	Parameter	APT5010B2VFR	UNIT
V _{DSS}	Drain-Source Voltage	500	Volts
I _D	Continuous Drain Current @ T _C = 25°C	47	Amps
I _{DM}	Pulsed Drain Current ^①	188	
V _{GS}	Gate-Source Voltage Continuous	±30	Volts
V _{GSM}	Gate-Source Voltage Transient	±40	
P _D	Total Power Dissipation @ T _C = 25°C	520	Watts
	Linear Derating Factor	4.16	W/°C
T _J , T _{STG}	Operating and Storage Junction Temperature Range	-55 to 150	°C
T _L	Lead Temperature: 0.063" from Case for 10 Sec.	300	
I _{AR}	Avalanche Current ^① (Repetitive and Non-Repetitive)	47	Amps
E _{AR}	Repetitive Avalanche Energy ^①	50	mJ
E _{AS}	Single Pulse Avalanche Energy ^④	2500	

STATIC ELECTRICAL CHARACTERISTICS

Symbol	Characteristic / Test Conditions	MIN	TYP	MAX	UNIT
BV _{DSS}	Drain-Source Breakdown Voltage (V _{GS} = 0V, I _D = 250μA)	500			Volts
I _{D(on)}	On State Drain Current ^② (V _{DS} > I _{D(on)} × R _{DS(on)} Max, V _{GS} = 10V)	47			Amps
R _{DS(on)}	Drain-Source On-State Resistance ^② (V _{GS} = 10V, 0.5 I _{D(Cont.)})			0.100	Ohms
I _{DSS}	Zero Gate Voltage Drain Current (V _{DS} = V _{DSS} , V _{GS} = 0V)			250	μA
	Zero Gate Voltage Drain Current (V _{DS} = 0.8 V _{DSS} , V _{GS} = 0V, T _C = 125°C)			1000	
I _{GSS}	Gate-Source Leakage Current (V _{GS} = ±30V, V _{DS} = 0V)			±100	nA
V _{GS(th)}	Gate Threshold Voltage (V _{DS} = V _{GS} , I _D = 2.5mA)	2		4	Volts

CAUTION: These Devices are Sensitive to Electrostatic Discharge. Proper Handling Procedures Should Be Followed.

APT Website - <http://www.advancedpower.com>

DYNAMIC CHARACTERISTICS

APT5010B2VFR

Symbol	Characteristic	Test Conditions	MIN	TYP	MAX	UNIT
C _{iss}	Input Capacitance	V _{GS} = 0V V _{DS} = 25V f = 1 MHz		7400	8900	pF
C _{oss}	Output Capacitance			1000	1400	
C _{riss}	Reverse Transfer Capacitance			380	570	
Q _g	Total Gate Charge ③	V _{GS} = 10V V _{DD} = 0.5 V _{DSS} I _D = I _D [Cont.] @ 25°C		312	470	nC
Q _{gs}	Gate-Source Charge			50	75	
Q _{gd}	Gate-Drain ("Miller") Charge			127	190	
t _{d(on)}	Turn-on Delay Time	V _{GS} = 15V V _{DD} = 0.5 V _{DSS} I _D = I _D [Cont.] @ 25°C R _G = 0.6Ω		14	30	ns
t _r	Rise Time			16	32	
t _{d(off)}	Turn-off Delay Time			54	80	
t _f	Fall Time			5	10	

SOURCE-DRAIN DIODE RATINGS AND CHARACTERISTICS

Symbol	Characteristic / Test Conditions	MIN	TYP	MAX	UNIT
I _S	Continuous Source Current (Body Diode)			47	Amps
I _{SM}	Pulsed Source Current ① (Body Diode)			188	
V _{SD}	Diode Forward Voltage ② (V _{GS} = 0V, I _S = -I _D [Cont.])			1.3	Volts
dv/dt	Peak Diode Recovery dv/dt ⑥			5	V/ns
t _{rr}	Reverse Recovery Time (I _S = -I _D [Cont.], di/dt = 100A/μs)	T _j = 25°C		250	ns
		T _j = 125°C		500	
Q _{rr}	Reverse Recovery Charge (I _S = -I _D [Cont.], di/dt = 100A/μs)	T _j = 25°C		1.6	μC
		T _j = 125°C		5.5	
I _{RRM}	Peak Recovery Current (I _S = -I _D [Cont.], di/dt = 100A/μs)	T _j = 25°C		15	Amps
		T _j = 125°C		27	

THERMAL CHARACTERISTICS

Symbol	Characteristic	MIN	TYP	MAX	UNIT
R _{θJC}	Junction to Case			0.24	°C/W
R _{θJA}	Junction to Ambient			40	

① Repetitive Rating: Pulse width limited by maximum junction temperature.

② Pulse Test: Pulse width < 380 μs, Duty Cycle < 2%

③ See MIL-STD-750 Method 3471

④ Starting T_j = +25°C, L = 2.26mH, R_G = 25Ω, Peak I_L = 47A

⑤ These dimensions are equal to the TO-247 without mounting hole

⑥ I_S ≤ -I_D [Cont.], di/dt = 100A/μs, V_{DD} ≤ V_{DSS}, T_j ≤ 150°C, R_G = 2.0Ω, V_R = 200V.

APT Reserves the right to change, without notice, the specifications and information contained herein.

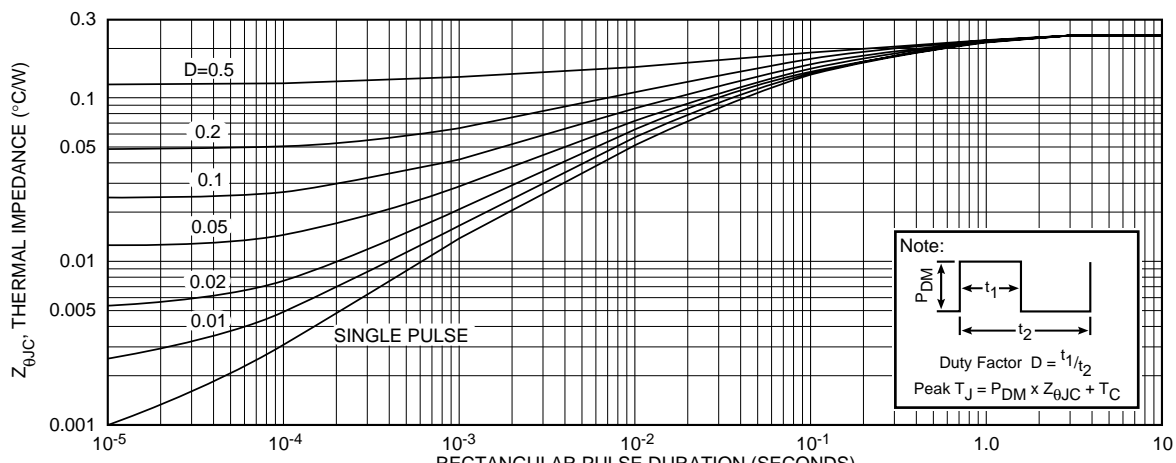

APT5010B2VFR

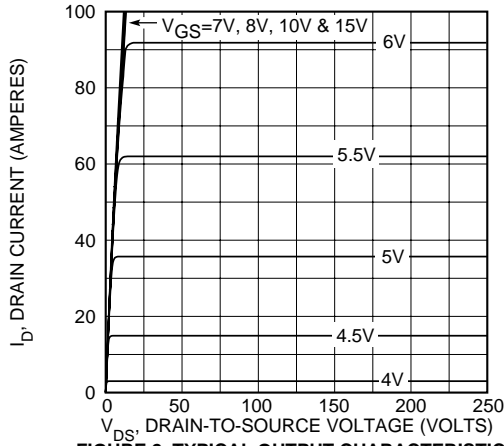

FIGURE 2, TYPICAL OUTPUT CHARACTERISTICS

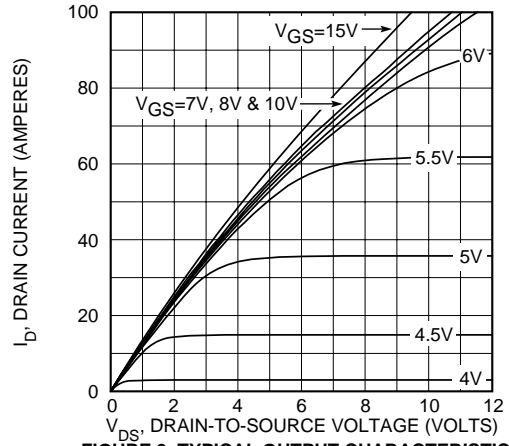

FIGURE 3, TYPICAL OUTPUT CHARACTERISTICS

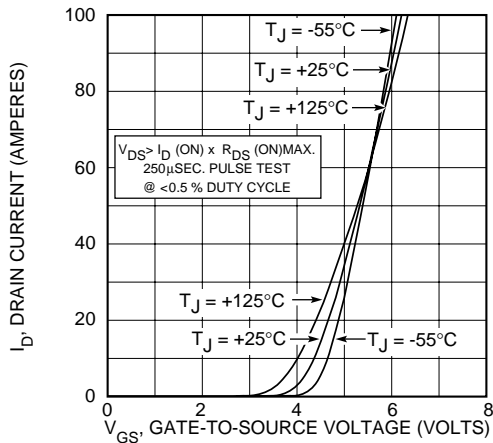

FIGURE 4, TYPICAL TRANSFER CHARACTERISTICS

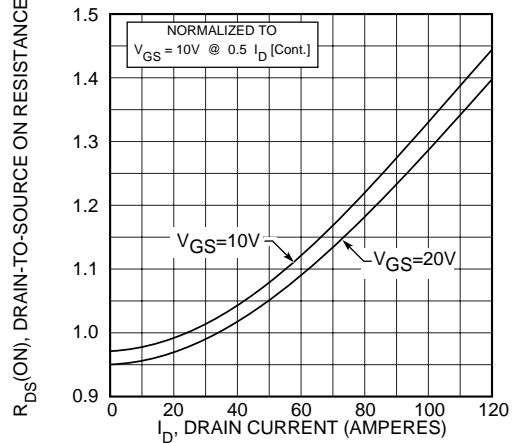

FIGURE 5, $R_{DS(ON)}$ vs DRAIN CURRENT

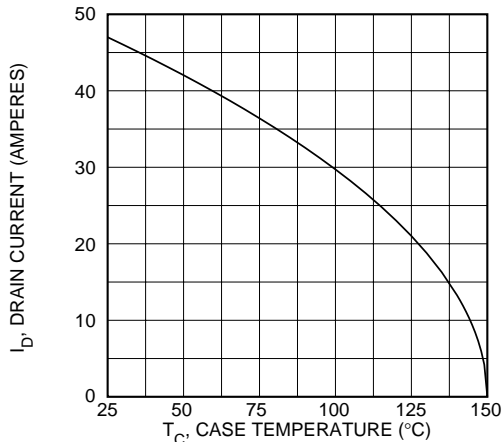

FIGURE 6, MAXIMUM DRAIN CURRENT vs CASE TEMPERATURE

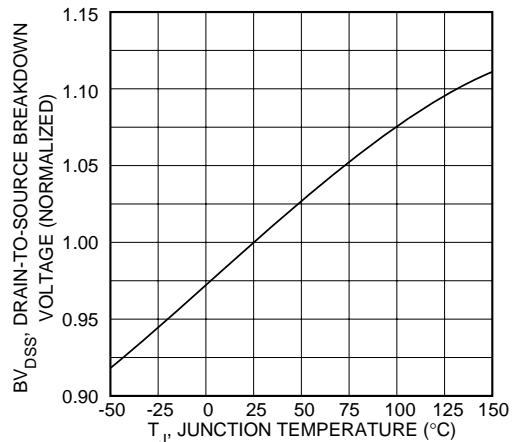

FIGURE 7, BREAKDOWN VOLTAGE vs TEMPERATURE

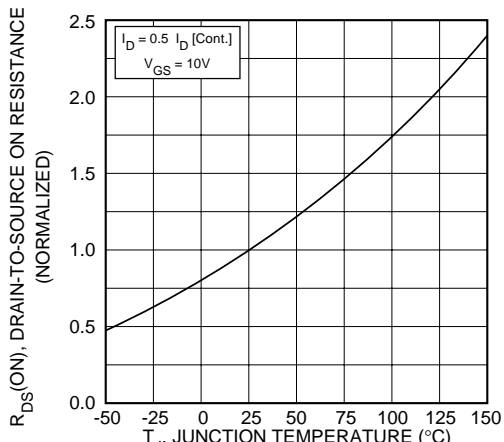

FIGURE 8, ON-RESISTANCE vs. TEMPERATURE

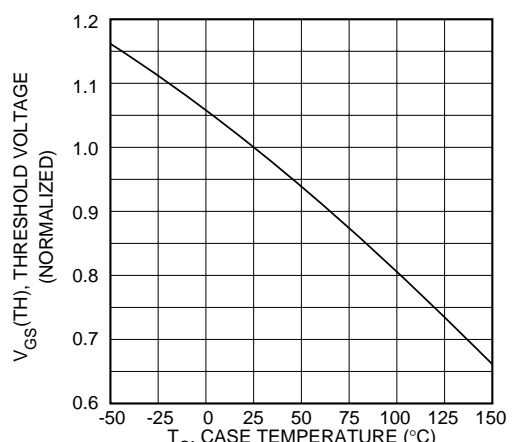

FIGURE 9, THRESHOLD VOLTAGE vs TEMPERATURE

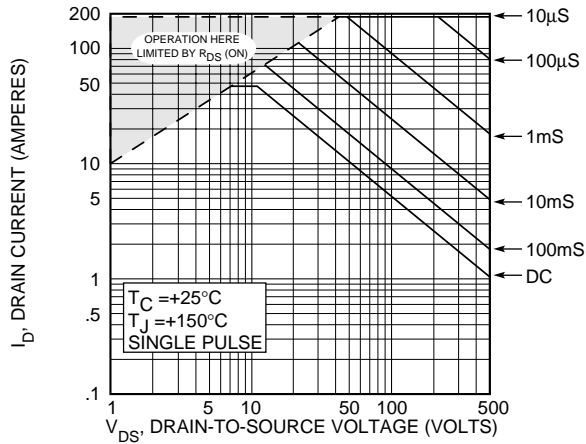

FIGURE 10, MAXIMUM SAFE OPERATING AREA

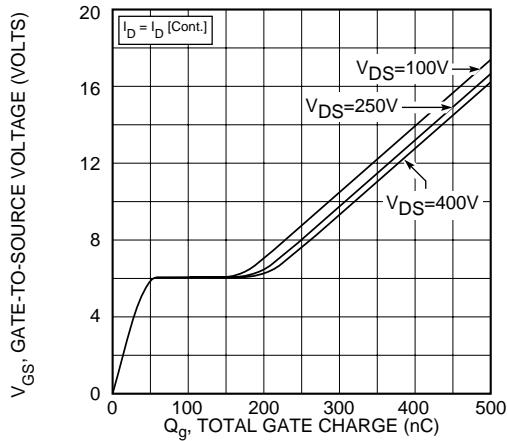

FIGURE 12, GATE CHARGES vs GATE-TO-SOURCE VOLTAGE

APT5010B2VFR

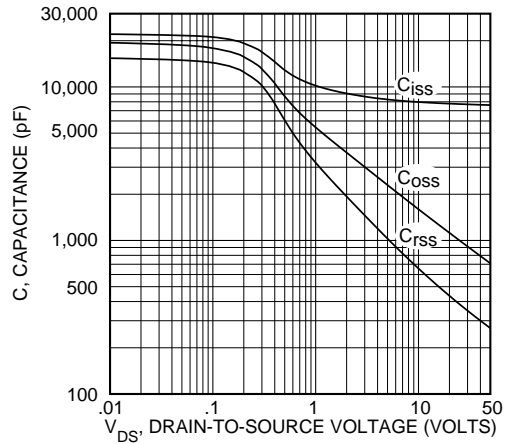

FIGURE 11, TYPICAL CAPACITANCE vs DRAIN-TO-SOURCE VOLTAGE

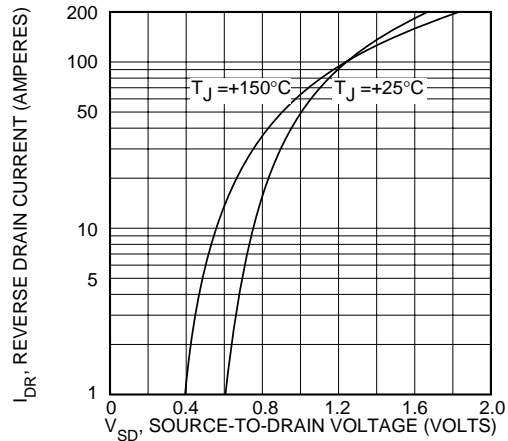
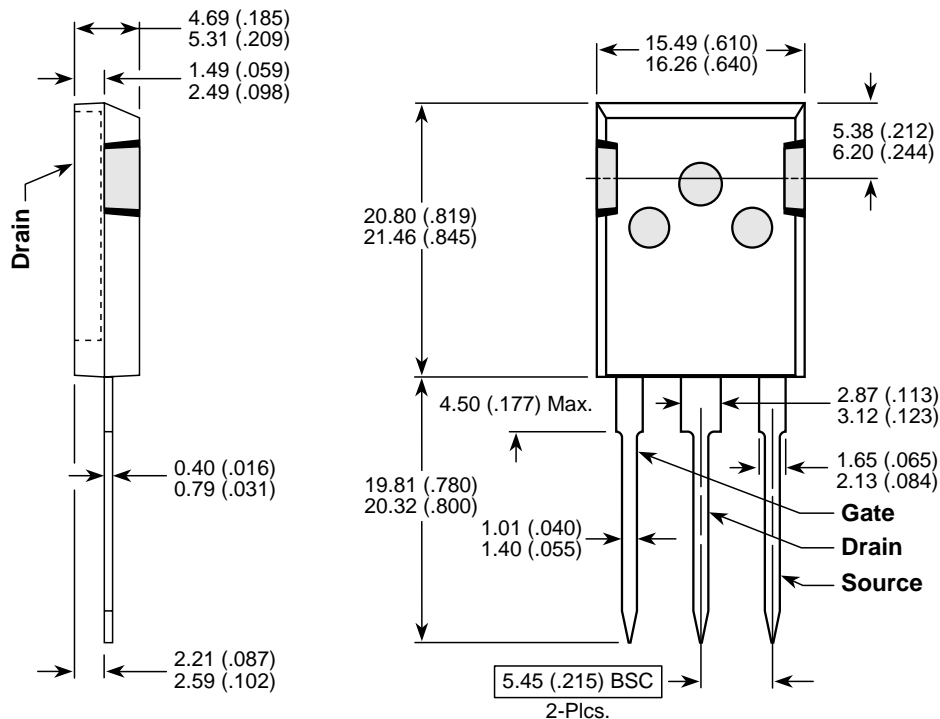

FIGURE 13, TYPICAL SOURCE-DRAIN DIODE FORWARD VOLTAGE

T-MAX™ Package Outline ⑤



Dimensions in Millimeters and (Inches)