

No.924E

2SB880/2SD1190

Silicon PNP/NPN Epitaxial Planar Type
Darlington Transistor
FOR VARIOUS DRIVERS

Applications

- Motor drivers, printer hammer drivers, relay drivers, voltage regulators

Features

- High DC current gain
- Large current capacity and wide ASO
- Low saturation voltage

(): 2SB880

Absolute Maximum Ratings/ $T_a=25^\circ\text{C}$

			unit
Collect-to-Base Voltage	V_{CB0}	(-)70	V
Collector-to-Emitter Voltage	V_{CE0}	(-)60	V
Emitter-to-Base Voltage	V_{EB0}	(-)6	V
Collector Current	I_C	(-)4	A
Peak Collector Current	i_{cp}	(-)6	A
Collector Dissipation	P_C	1.75	W
		$T_c=25^\circ\text{C}$	30
Junction Temperature	T_j	150	$^\circ\text{C}$
Storage Temperature	T_{stg}	-55 to +150	$^\circ\text{C}$

Electrical Characteristics/ $T_a=25^\circ\text{C}$

			min	typ	max	unit
Collector Cut-off Current	I_{CB0}	$V_{CB}=(-)40, I_E=0$			(-)0.1	mA
Emitter Cut-off Current	I_{EB0}	$V_{EB}=(-)5V, I_C=0$			(-)3.0	mA
DC Current Gain	h_{FE}	$V_{CE}=(-)2V, I_C=(-)2A$	2000	5000		
Gain Band-width Product	f_T	$V_{CE}=(-)5V, I_C=(-)2A$		20		MHz
Collector to Emitter Saturation Voltage	$V_{CE(sat)}$	$I_C=(-)2A, I_B=(-)4mA$		0.9	(-)1.5	V
				(-1.0)		
Base to Emitter Saturation Voltage	$V_{BE(sat)}$	$I_C=(-)2A, I_B=(-)4mA$			(-)2.0	V
Collector to Base Breakdown Voltage	$V_{(BR)CB0}$	$I_C=(-)5mA, I_E=0$	(-)70			V
Collector to Emitter Breakdown Voltage	$V_{(BR)CE0}$	$I_C=(-)50mA, R_{BE}=\infty$	(-)60			V
Turn-on Time	t_{on}	At Specified Test Circuit		(0.5)0.6		μs
Storage Time	t_{stg}	"		(1.4)2.7		μs
Fall Time	t_f	"		(1.2)1.6		μs

Specified Test Circuit

(For PNP, the polarity is reversed.)

$PW=50\mu\text{s}, \text{Duty Cycle} \leq 1\%$
 $500I_{B1} = -500I_{B2} = I_C = 2A$

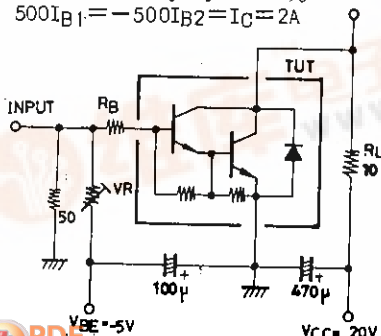

Electrical Connection

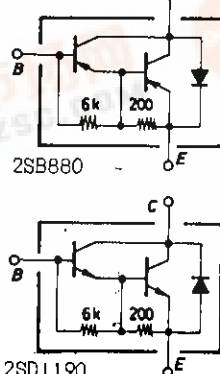

Package Dimensions 2010B

(unit: mm)

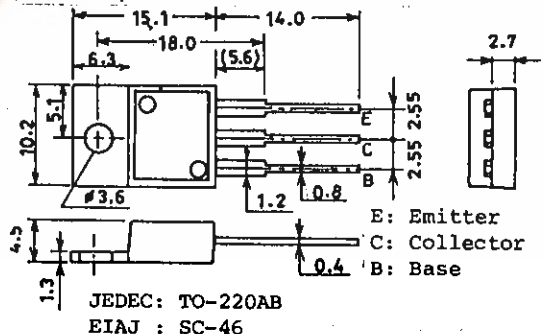

Unit (resistance: Ω , capacitance: F)

2SB880/2SD1190

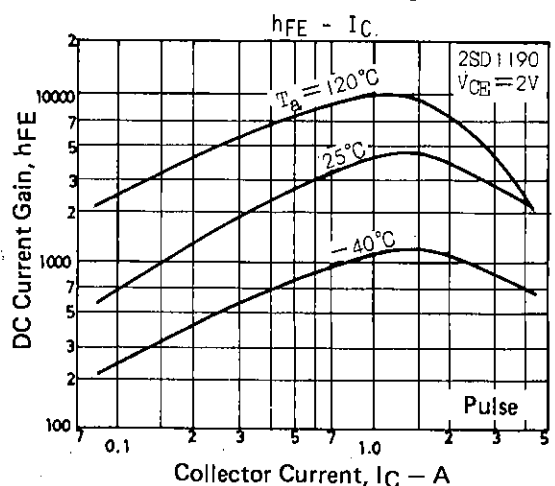
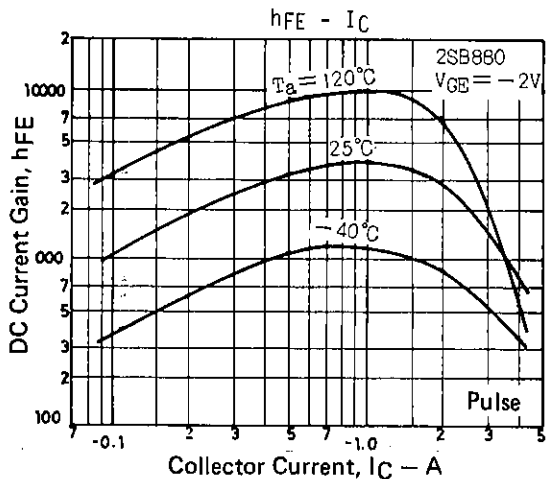
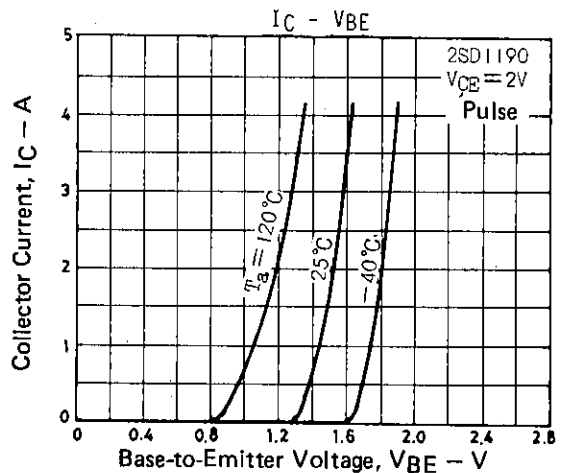
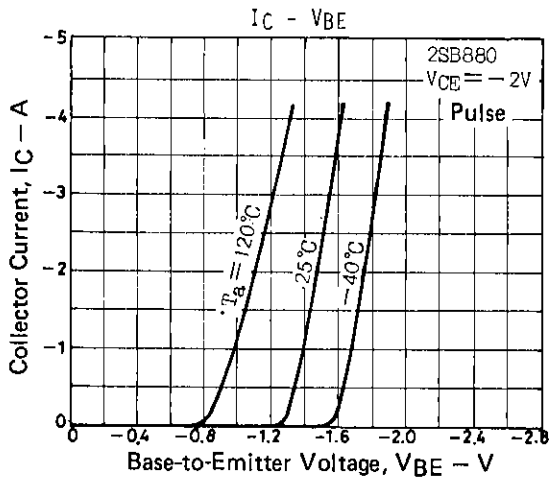
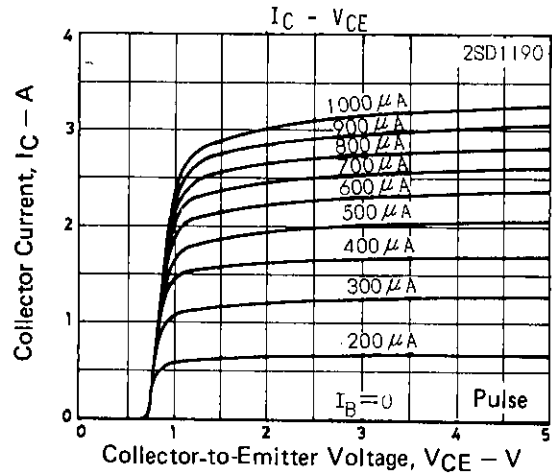
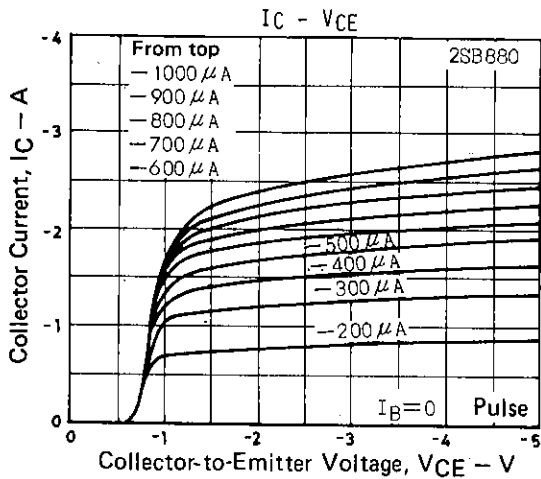
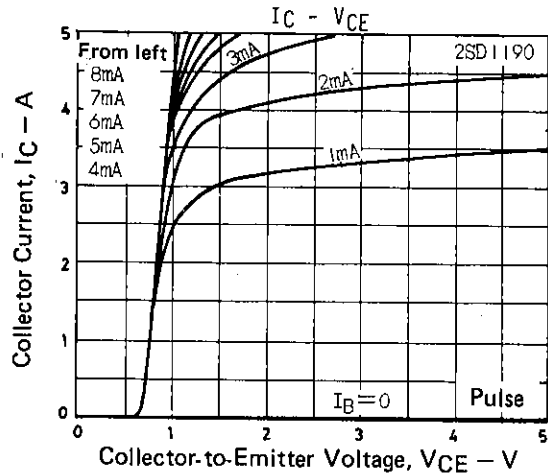
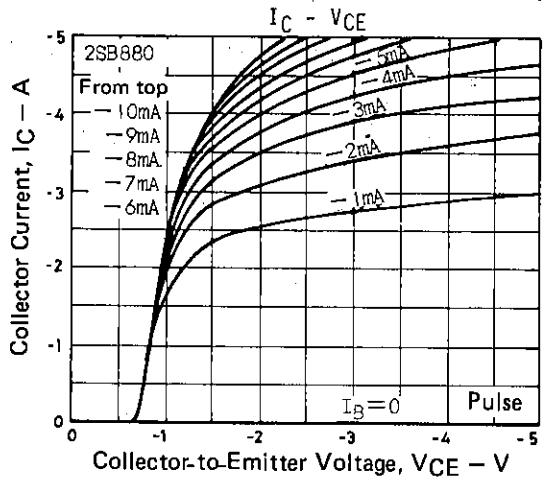

2SB880/2SD1190

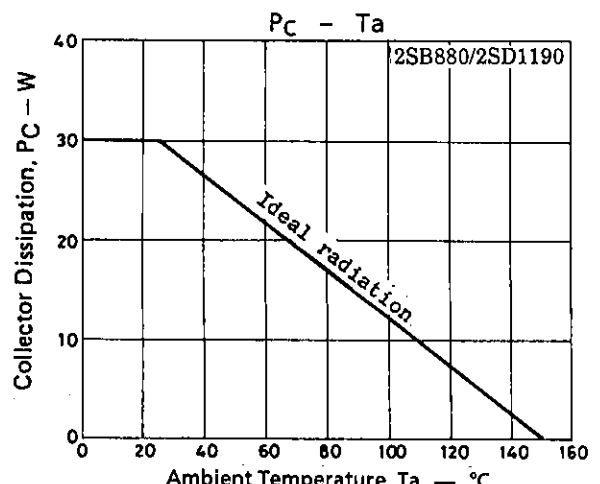
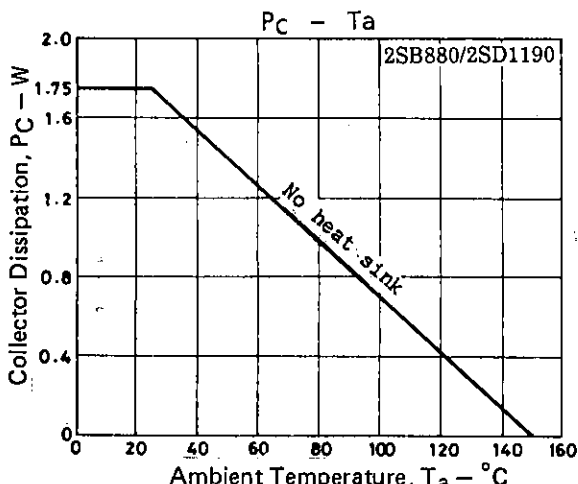
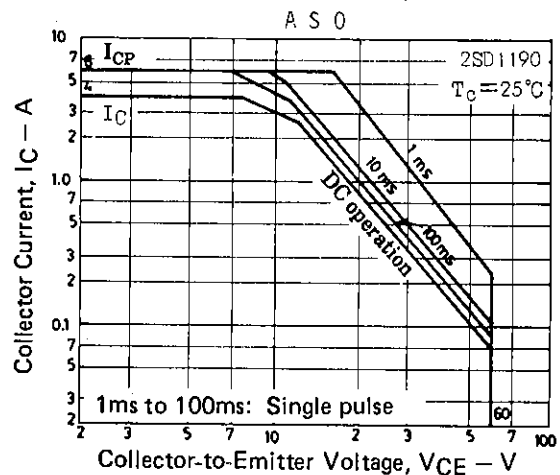
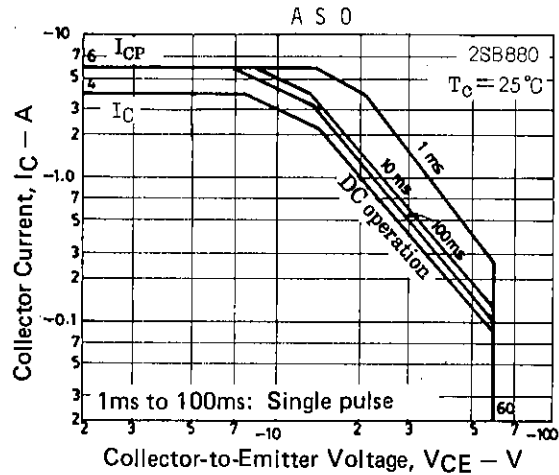
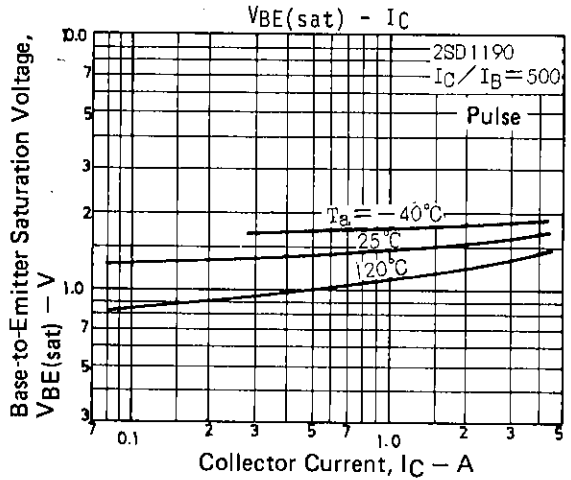
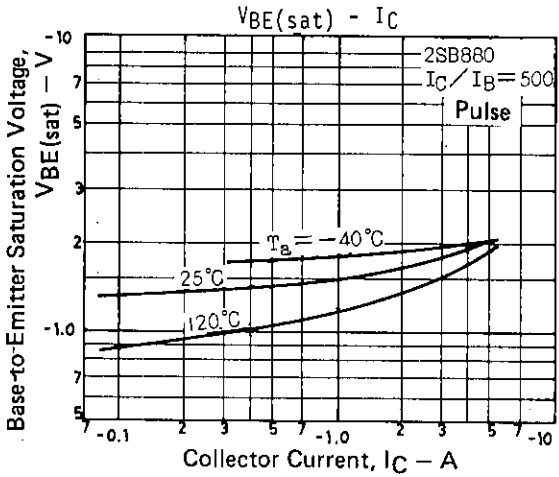
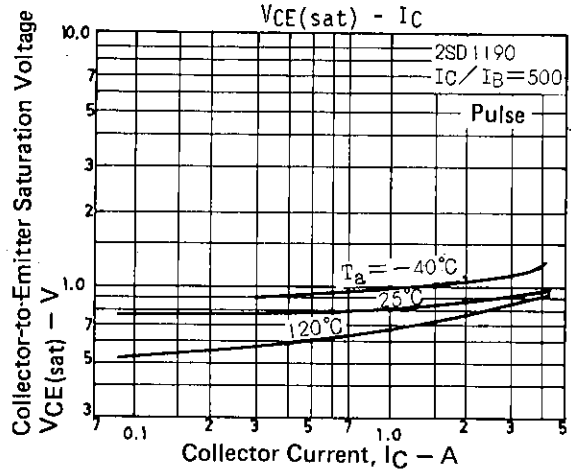
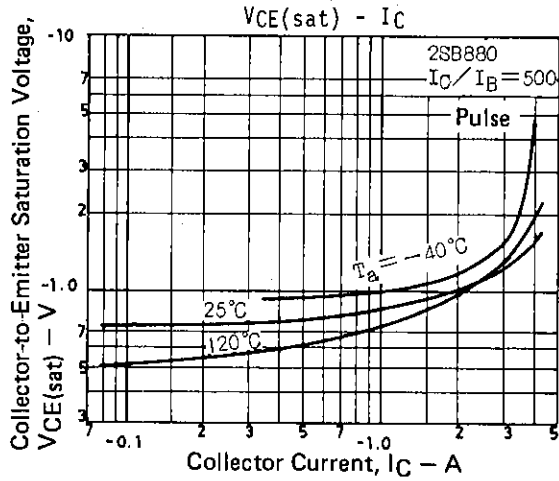

- No products described or contained herein are intended for use in surgical implants, life-support systems, aerospace equipment, nuclear power control systems, vehicles, disaster/crime-prevention equipment and the like, the failure of which may directly or indirectly cause injury, death or property loss.
- Anyone purchasing any products described or contained herein for an above-mentioned use shall:
 - ① Accept full responsibility and indemnify and defend SANYO ELECTRIC CO., LTD., its affiliates, subsidiaries and distributors and all their officers and employees, jointly and severally, against any and all claims and litigation and all damages, cost and expenses associated with such use:
 - ② Not impose any responsibility for any fault or negligence which may be cited in any such claim or litigation on SANYO ELECTRIC CO., LTD., its affiliates, subsidiaries and distributors or any of their officers and employees jointly or severally.
- Information (including circuit diagrams and circuit parameters) herein is for example only; it is not guaranteed for volume production. SANYO believes information herein is accurate and reliable, but no guarantees are made or implied regarding its use or any infringements of intellectual property rights or other rights of third parties.