

BA4234L BA4235L

T-77-05-07

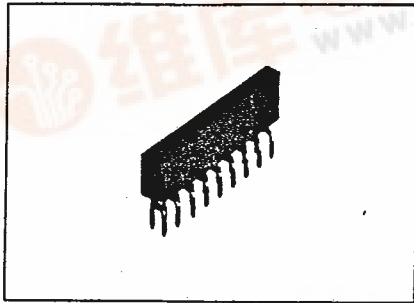

Dimensions (Unit: mm)

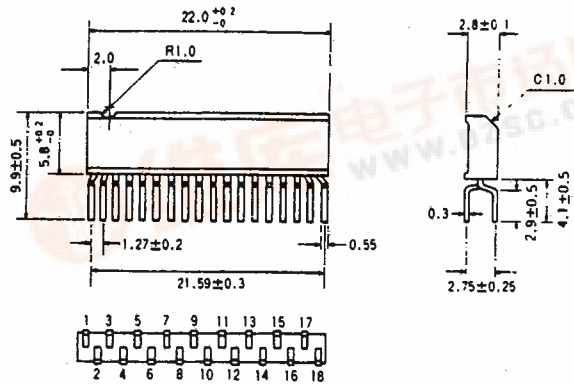

Fig. 1

The BA4234L and 4235L are single-chip FM IF systems with their S-shaped FM discrimination curves opposite (symmetrical) to each other.

The FM section of the devices consists of a differential IF amplifier, double-balanced quadrature detector, and IF muting circuit for weak signals. The AM section consists of a local oscillator, double-balanced mixer, IF amplifier, detector, and AGC circuit.

The devices also contain an audio amplifier and LED drivers for FM/AM tuning indicators.

Block Diagram

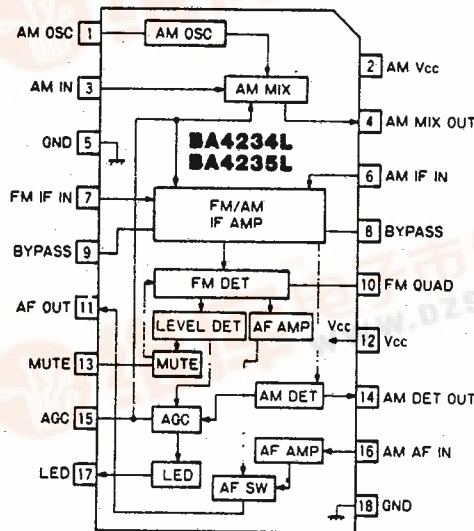

Fig. 2

Features

1. Two different S-shaped FM discrimination curves are available depending on the AFC circuit used: reverse curve with the BA4234L, and forward curve with the BA4235L.
2. Wide supply voltage range of 3.0 – 12V.
3. Built-in AM local oscillator, mixer, and detector circuits assure stable AM operations from LW through SW.
4. High margin to AM input overload (with shunt AGC).
5. Built-in muting circuit for a weak FM signal reduces inter-station white noise and off-tuned side peaks. The muting circuit can be turned on or off with an external switch.
6. Built-in FM/AM tuning indicator drivers with direct LED driving capability.
7. Single-pin output for the FM and AM circuits allows coupling to the following stage (MPX, etc.) without a selector switch.
8. Exclusive frequency response setting pin for the AM circuit allows the FM and AM circuits to have independent frequency responses. This facilitates coupling to the MPX circuit.
9. Switching between FM and AM modes can be performed with DC level switching.

Absolute Maximum Ratings (Ta=25°C)

Parameter	Symbol	Limits	Unit
Supply voltage	Vcc	16	V
Power dissipation	Pd	550*	mW
Operating temperature range	Topr	-25~75	°C
Storage temperature range	Tstg	-55~125	°C

* Derating is done at 5.5mW/°C for operation above Ta=25°C

Recommended Operating Conditions

Parameter	Symbol	Min.	Typ.	Max.	Unit	Conditions
Supply voltage	Vcc	3.0	6.0	12	V	—

Applications

- FM/AM portable radios
- Radio cassette recorders
- Home stereo systems
- Car stereo systems



Electrical Characteristics/FM Section (Ta=25°C, VCC=5.5V, VIN=100dBμV, fIN=10.7MHz, fm=1kHz, Δf=22.5kHz)

Parameter	Symbol	Min	Typ	Max	Unit	Conditions	Test circuit
Quiescent current	I _Q	—	8	12	mA	MUTE OFF	Fig 3
Detector output	V _{OUT}	60	90	120	mV	—	Fig 3
Total harmonic distortion	THD	—	0.06	0.25	%	—	Fig 3
Signal-to-noise ratio	S/N	64	70	—	dB	—	Fig 3
Limiting sensitivity	V _{IN(LIM)}	28	32	36	dBμV	V _{OUT} =-3dB	Fig.3
LED turn-on sensitivity	V _{IN(LED)}	45	50	55	dBμV	I _{LED} =1mA	Fig 3
Noise under no input	N	-20	-30	—	dB	V _{IN} =-20dBμV	Fig 3
Noise rejection ratio	NS	-38	—	—	dB	MUTE ON/OFF	Fig 3

Electrical Characteristics/AM Section (Ta=25°C, VCC=5.5V, VIN=1MHz, fm=1kHz, MOD=30%)

Parameter	Symbol	Min	Typ	Max	Unit	Conditions	Test circuit
Detector output	V _{OUT}	60	90	125	mV	—	Fig 3
Total harmonic distortion	THD	—	0.6	2	%	—	Fig 3
Signal-to-noise ratio	S/N	44	52	—	dB	—	Fig 3
Maximum sensitivity	V _{IN(MAX)}	9	13	17	dBμV	V _{OUT} =10mV	Fig 3
LED turn-on sensitivity	V _{IN(LED)}	19	24	29	dBμV	I _{LED} =1mA	Fig 3

Test Circuit

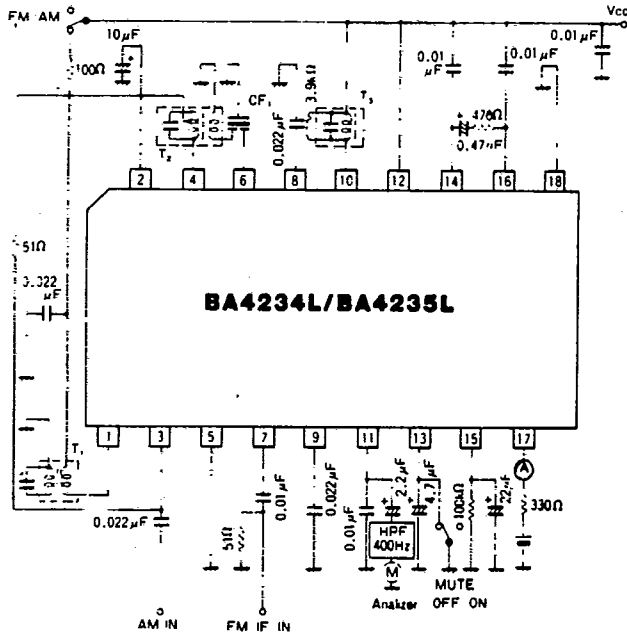

- T₁ : AM OSC
- T₂ : AM IFT
- T₃ : FM DET
- CF₁: AM ceramic filter

Fig. 3

Application Board Schematic Diagram

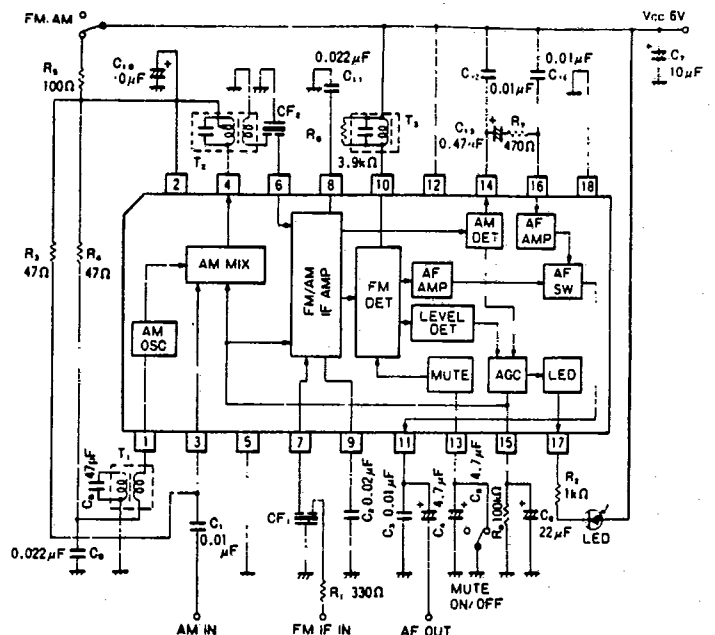

- T₁ : AM OSC
 - T₂ : AM IFT
 - T₃ : FM DET
 - CF₁: FM ceramic filter
 - CF₂: AM ceramic filter
- Note: The electrical characteristic curves are obtained from this application circuit.

Fig. 4

RF and IF Amplifiers

Application Example

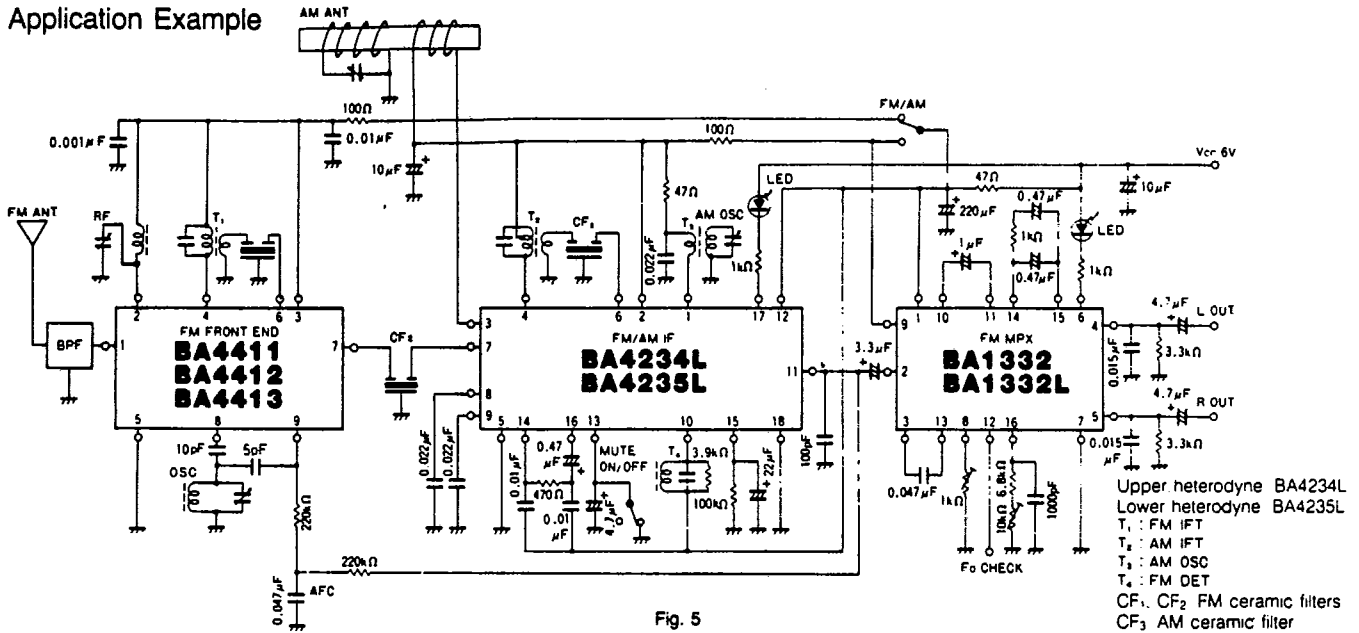

Fig. 5

Precautions for Use

1. Leakage from AM local oscillation or noise applied to the AM IF input pin (pin 6) may cause a tuning indicator drive error or a sensitivity drop. Use the shortest possible wiring path from the AM ceramic filter output to the IF input pin (pin 6).
2. Ground the FM detection coil at the output section GND or at Vcc. If it is grounded at the input section GND, unstable operation may occur because of feedback.
3. When observing the S-shaped FM discrimination curve with an oscilloscope and sweep generator, turn off the muting. If the muting is left on, the muting circuit time constant may cause an observation error.
4. Note that the FM muting level varies depending on the noise level at the FM front end.
5. The value of the stabilizing resistor for

- the AM local oscillator should be from 0 to 47Ω.
6. A ceramic discriminator can be used in place of the FM quadrature coil to allow for an alignment-free FM IF circuit.

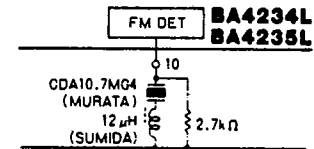

Fig. 6

Specifications of Inductors

- 1 T₂ FM IFT (455kHz) 2150-2173-157 (by Sumida)

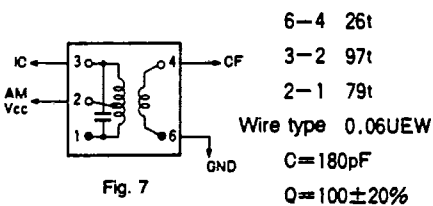

Fig. 7

- 2 T₃ AM OSC coil 2157-2239-295 (by Sumida)

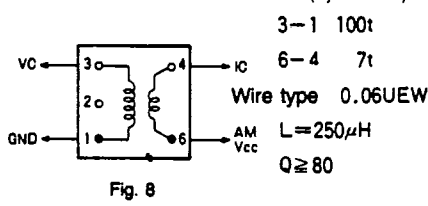

Fig. 8

- 3 T₄ FM DET (10.7MHz) 2153-409-090 (by Sumida)

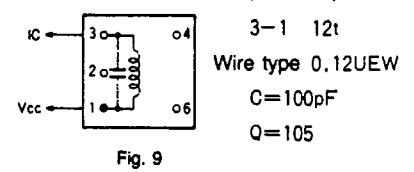

Fig. 9

Electrical Characteristic Curves

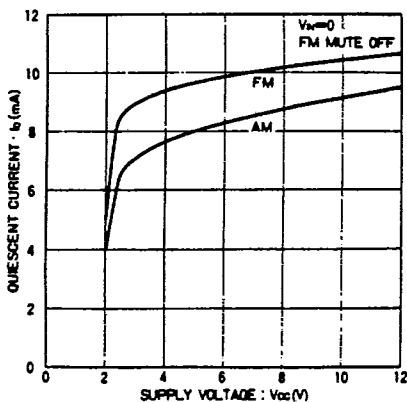

Fig. 10 Quiescent current vs. supply voltage

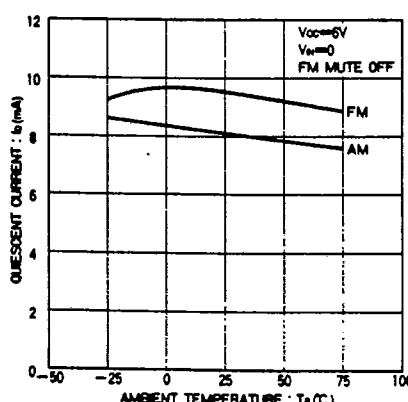

Fig. 11 Quiescent current vs. ambient temperature

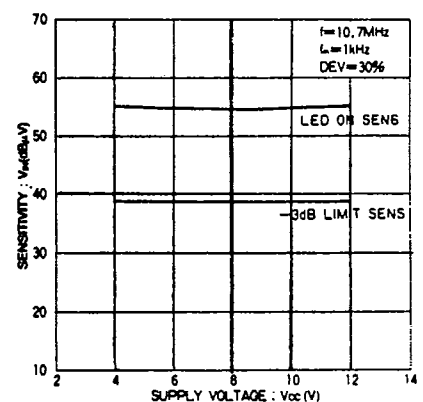

Fig. 12 FM sensitivity vs. supply voltage

Electrical Characteristic Curves

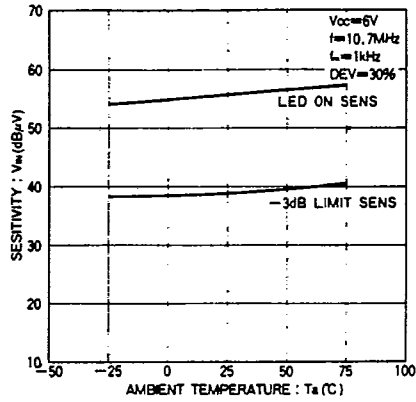

Fig. 13 FM sensitivity vs. ambient temperature

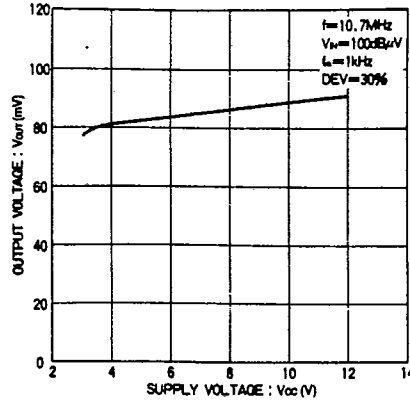

Fig. 14 FM detector output voltage vs. supply voltage

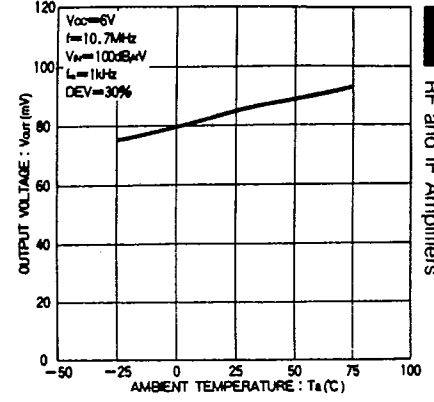

Fig. 15 FM detector output voltage vs. ambient temperature

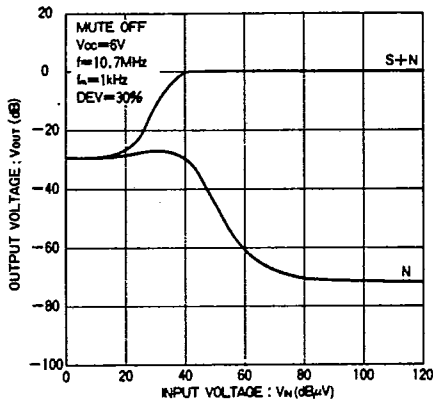

Fig. 16 FM detector output voltage (muting off) vs. input voltage

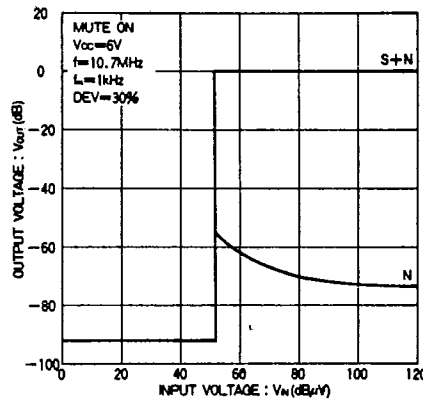

Fig. 17 FM detector output voltage (muting on) vs. input voltage

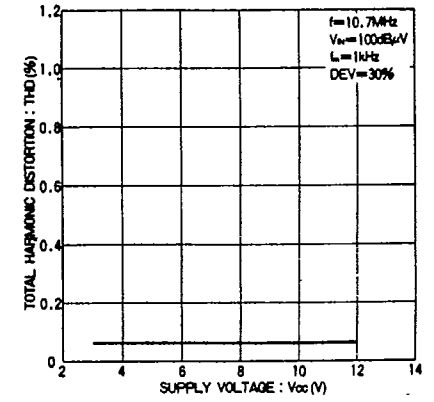

Fig. 18 FM total harmonic distortion vs. supply voltage

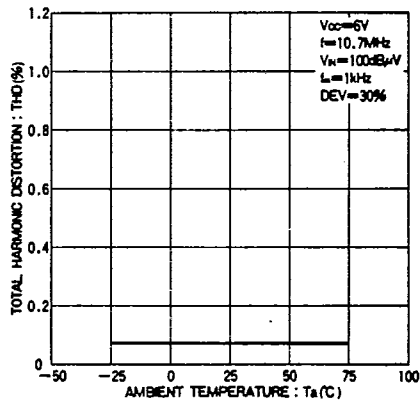

Fig. 19 FM total harmonic distortion vs. ambient temperature

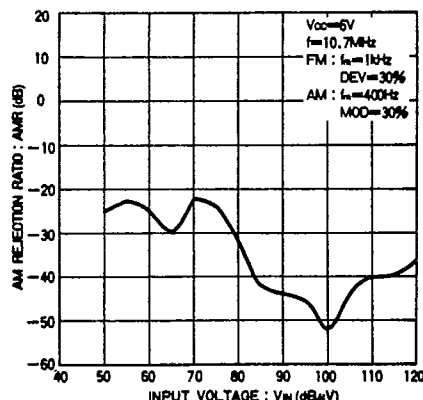

Fig. 20 FMAM rejection ratio vs. input voltage

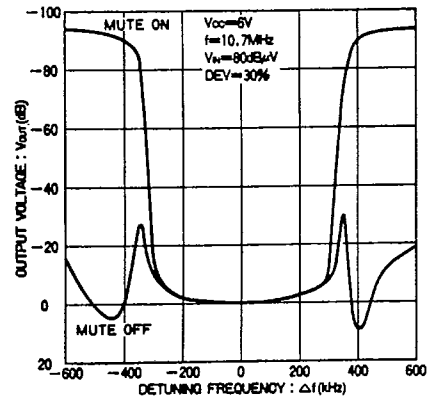

Fig. 21 FM detector output voltage vs. detuning frequency

T-77-05-07

Electrical Characteristic Curves

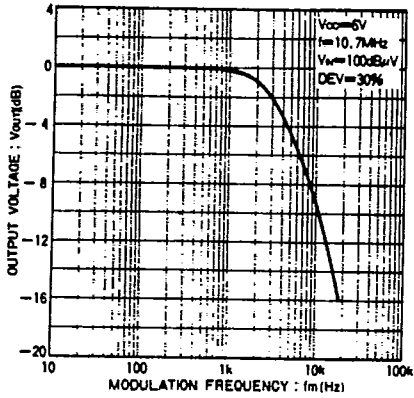

Fig. 22 FM detector output voltage vs. modulation frequency

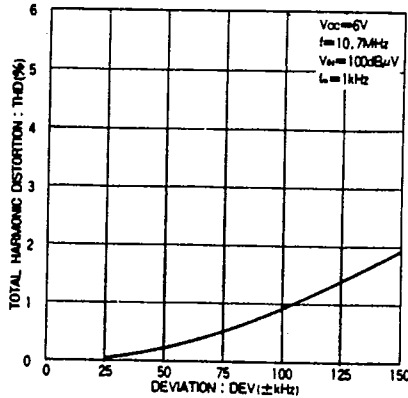

Fig. 23 FM total harmonic distortion vs. deviation

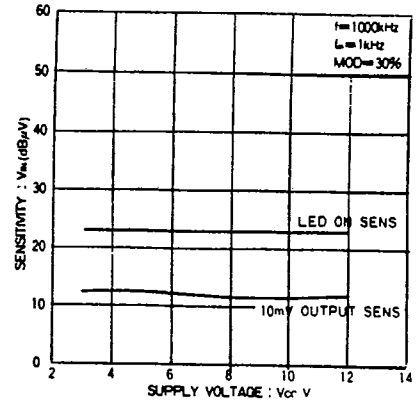

Fig. 24 AM sensitivity vs. supply voltage

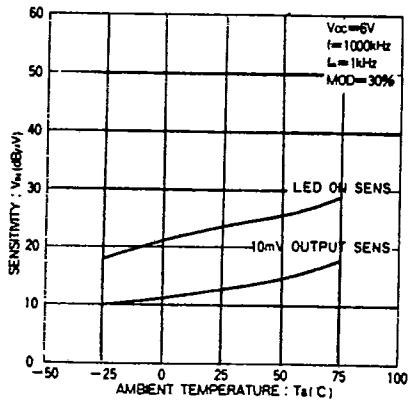

Fig. 25 AM sensitivity vs. ambient temperature

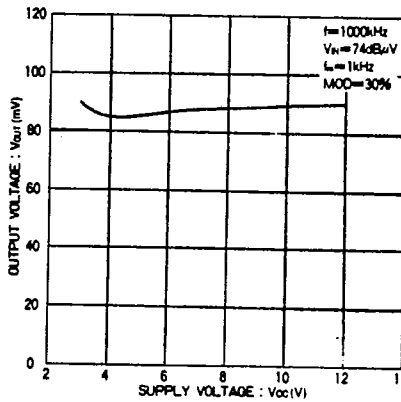

Fig. 26 AM detector output voltage vs. supply voltage

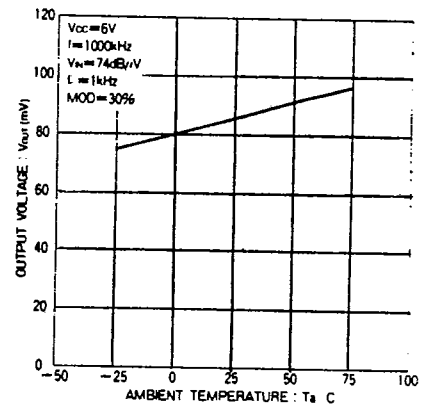

Fig. 27 AM detector output voltage vs. ambient temperature

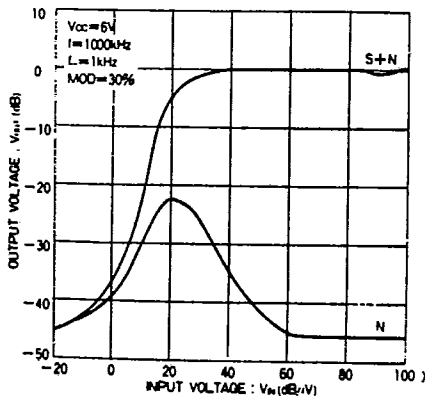

Fig. 28 AM detector output voltage vs. input voltage

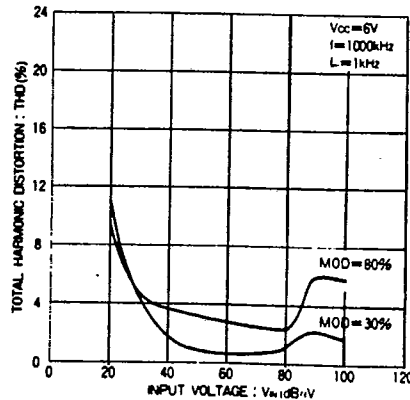

Fig. 29 AM total harmonic distortion vs. input voltage

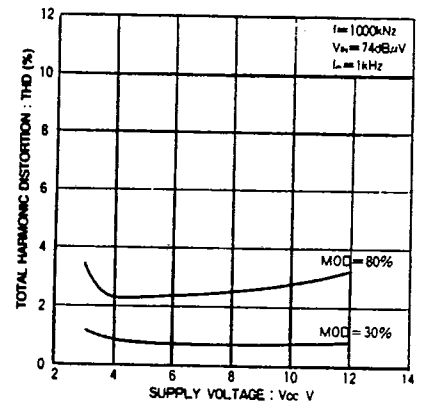

Fig. 30 AM total harmonic distortion vs. supply voltage

Electrical Characteristic Curves

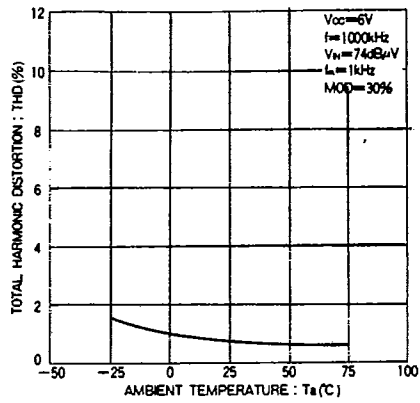

Fig. 31 AM total harmonic distortion vs. ambient temperature

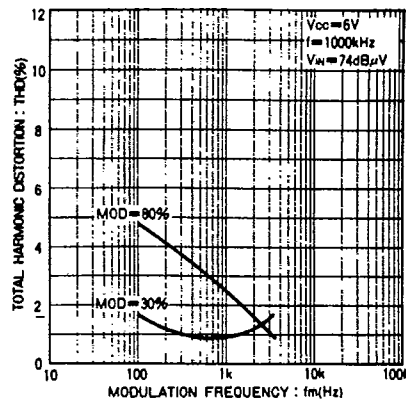

Fig. 32 Total harmonic distortion vs. modulation frequency

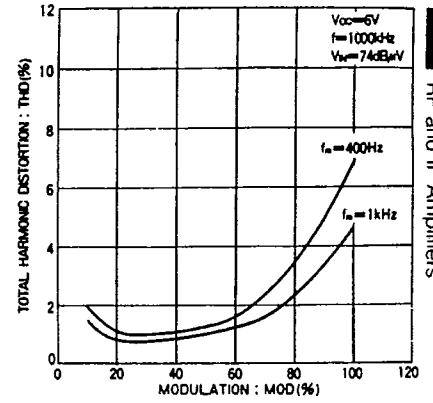

Fig. 33 AM total harmonic distortion vs. modulation frequency

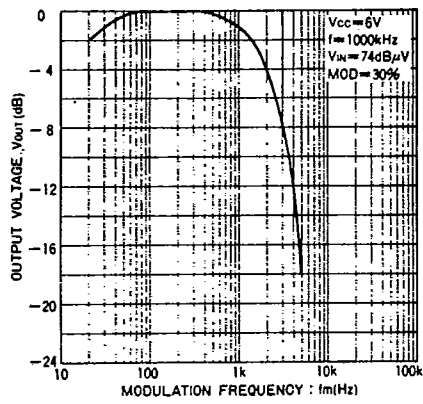

Fig. 34 AM detector output voltage vs. modulation frequency