

Dual Voltage-controlled Amplifier

BA7655A / BA7655AF

The BA7655A and BA7655AF are dual voltage-controlled amplifier ICs designed for use in camcorders and VCRs. By varying the control voltage the amplifier gain can be varied from -6dB to +6dB. When the control pin voltage drops below 1V the amplifier enters Power Save Mode which mutes the output and reduces the current drawn by the IC.

●Applications

Video cassette recorders and camcorders

●Features

- 1) Wide bandwidth.
- 2) Wide dynamic range.
- 3) Low power consumption.
- 4) Output muting possible.
- 5) Low voltage gain temperature drift.

●Block diagram

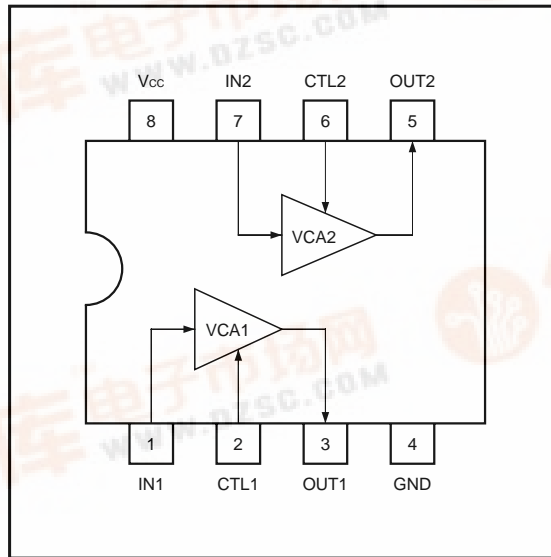

●Pin descriptions

Pin No.	Pin name	Function
1	IN1	Input 1
2	CTL1	Control 1
3	OUT1	Output 1
4	GND	GND
5	OUT2	Output 2
6	CTL2	Control 2
7	IN2	Input 2
8	Vcc	Power supply

●Input circuits

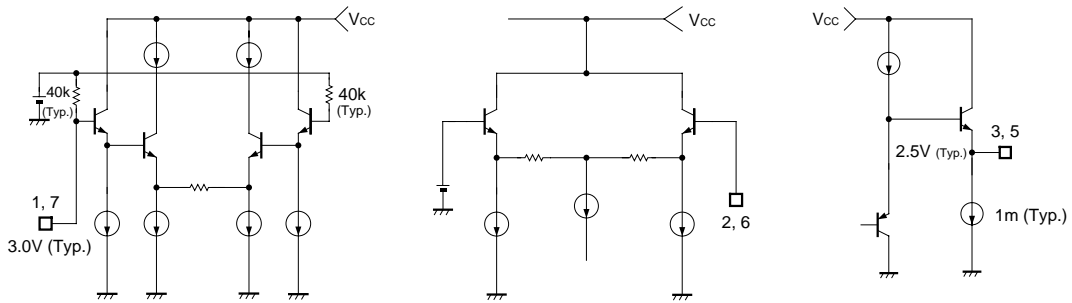

●Absolute maximum ratings

Parameter	Symbol	Limits	Unit
Power supply voltage	V _{CCMax.}	8.0	V
Power dissipation	P _d	500 (BA7655A : DIP8)*1 350 (BA7655AF : SOP8)*2	mW
Operating temperature	T _{opr}	- 20 ~ + 80	°C
Storage temperature	T _{stg}	- 55 ~ + 125	°C

*1 Reduced by 5.0mW for each increase in Ta of 1°C over 25°C.

*2 Reduce by 3.5mW for each increase in Ta of 1°C over 25°C, when mounted on a 50mm × 50mm.

●Recommended operating conditions (Ta = 25°C)

Parameter	Symbol	Limits	Unit
Power supply voltage	V _{CC}	4.5 ~ 5.5	V

●Electrical characteristics (unless otherwise noted , Ta = 25°C , Vcc = 5.0V)

Parameter		Symbol	Min.	Typ.	Max.	Unit	Voltage	Conditions
Supply current	One channel	ICC1	—	4.6	7.0	mA	3.0	Set control voltage to 1V or less, when only one channel is used.
	Both channels	ICC2	—	7.8	12.0			
Maximum output voltage		VMax.	2.5	2.8	—	V _{P-P}	5.0	f = 1kHz, THD = 1%
Frequency characteristics		Gf	-1.0	0.0	1.0	dB	3.0	f = 13MHz / 1MHz, V _{IN} = 0.5V _{P-P}
Minimum voltage gain		GVMin.	-8.0	-6.0	-4.0	dB	2.0	f = 1MHz
Maximum voltage gain		GVMax.	4.0	6.0	8.0	dB	5.0	f = 1MHz
Secondary harmonic distortion		2HD	—	-40	—	dB	3.0	f = 5.0M, V _{IN} = 1V _{P-P}
Audio distortion		AD	—	1.0	—	%	3.0	f = 1kHz, V _{IN} = 1V _{P-P}
Muting output voltage		VMUTE	—	—	100	mV	1.0	Set control voltage to 1 V or less
Video	S / N *	V S / N	—	-60	—	dB	3.0	
Audio	S / N *	A S / N	—	-60	—	dB	3.0	

* Items marked with an asterisk are reference values.

○ Not designed for radiation resistance.

●Circuit operation

The gain of a VCA (voltage-controlled amplifier) can be varied by an external control voltage. By varying the control voltage from 2V to 5V (in the case of a 5V power supply), the gain of the amplifiers in this IC can be varied over the range -6dB to +6dB (see Figs. 1 and 2 below).

When only one of the two amplifiers is being used, by setting the voltage on the CTL pin of the unused amplifier to 1V or less, it can be put into Power Save Mode. In Power Save Mode, the circuit current for the IC is cut by 40%, and the output is muted.

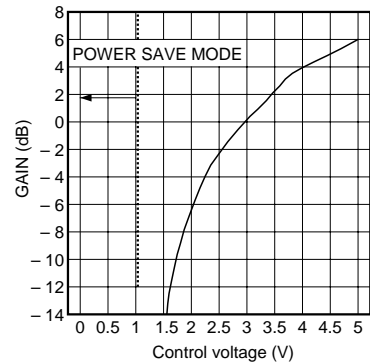

Fig. 1 Voltage gain vs. control voltage characteristics

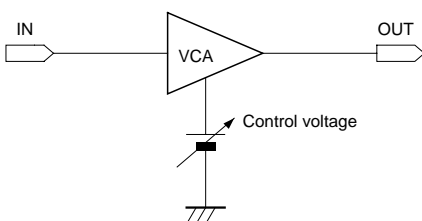

Fig. 2

CTL Voltage	Status
2V ~ 5V	Variable gain
1V or less	Power save

●Electrical characteristic curves

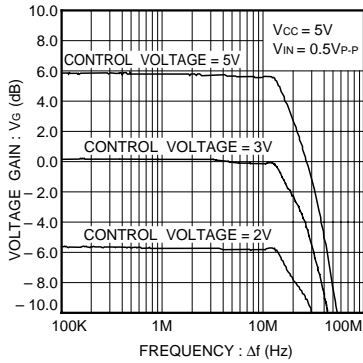

Fig. 3 Voltage gain vs. frequency

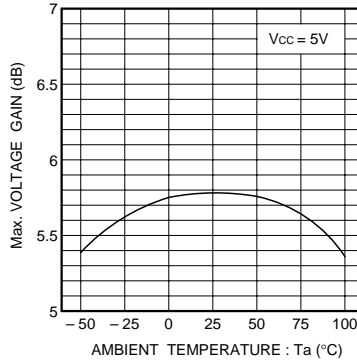

Fig. 4 Maximum voltage gain vs. ambient temperature

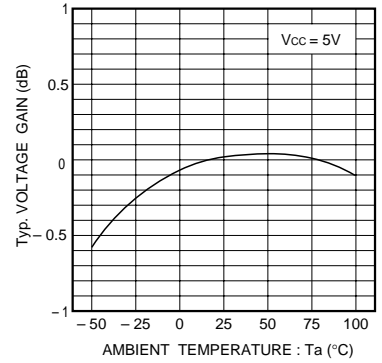

Fig. 5 Voltage gain vs. temperature

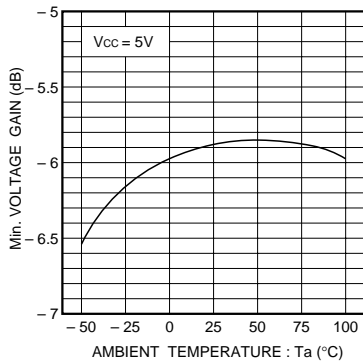
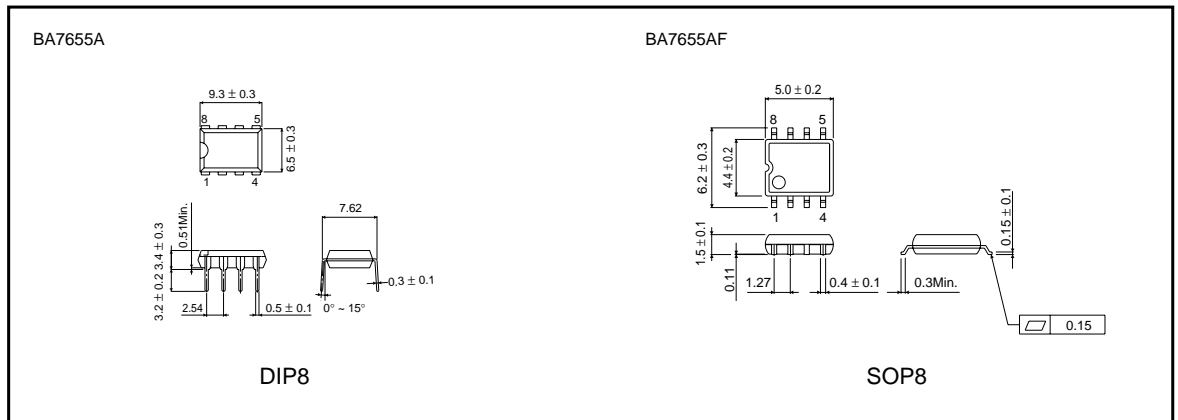

Fig. 6 Minimum voltage gain vs. temperature

●External dimensions (Units: mm)



DIP8

SOP8