

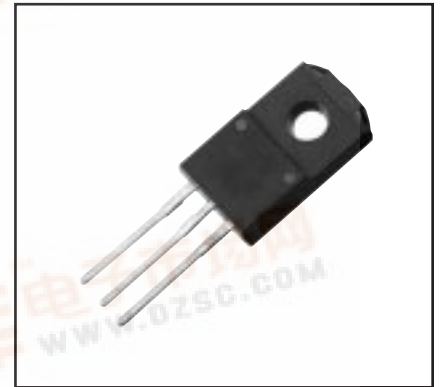

## BCR10PM

Powerex, Inc., 200 Hillis Street, Youngwood, Pennsylvania 15697-1800 (412) 925-7272

### Isolated Triac 10 Amperes/400-600 Volts

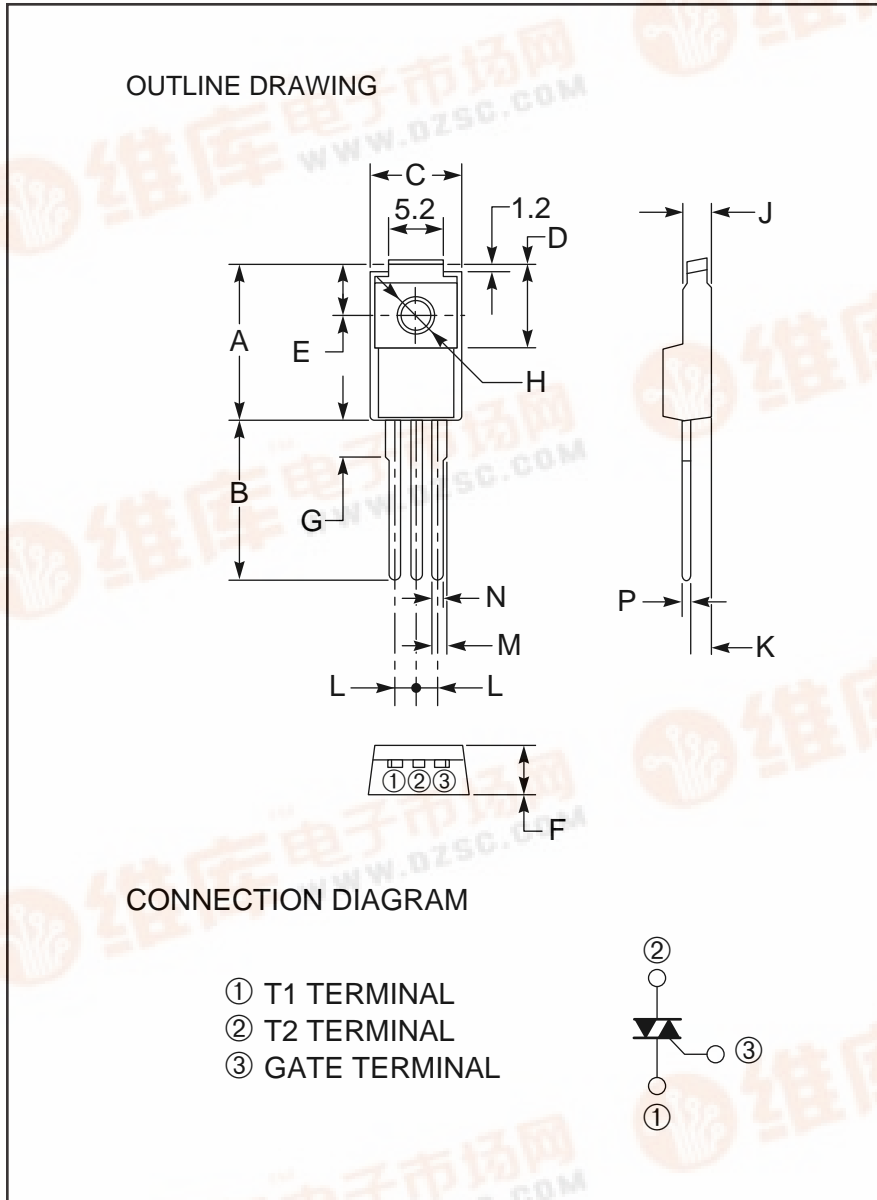

#### Description:

A triac is a solid state silicon AC switch which may be gate triggered from an off-state to an on-state for either polarity of applied voltage.

#### Features:

- Full Molded Isolation Package
- Glass Passivation
- 1500 V<sub>RMS</sub> Isolation Voltage
- UL Recognition
- Excellent Surge Capability
- Selected for Inductive Loads

#### Applications:

- AC Switch
- Motor Controls
- Lighting
- Switch Mode Power Supply

#### Ordering Information:

Example: Select the complete eight, nine or ten digit part number you desire from the table - i.e. BCR10PM-8 is a 400 Volt, 10 Ampere Triac.

Type	V <sub>DRM</sub> Volts	Code	Inductive Load*
BCR10PM	400	-8	L
	600	-12	

\*For inductive load, add L.

Outline Drawing (Conforms to TO-220F)

Dimensions	Inches	Millimeters
A	0.67	17.0
B	0.49 Min.	12.5 Min.
C	0.39	10.0
D	0.33	8.5
E	0.20	5.0
F	0.18	4.5
G	0.14	3.6

Dimensions	Inches	Millimeters
H	0.126 ±0.008 Dia.	3.2 ±0.2 Dia.
J	0.11	2.8
K	0.102	2.6
L	0.10	2.5
M	0.039	1.0
N	0.031	0.8
P	0.020	0.5

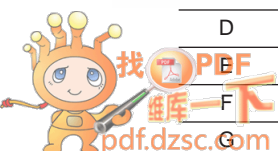



Powerex, Inc., 200 Hillis Street, Youngwood, Pennsylvania 15697-1800 (412) 925-7272

**BCR10PM**

**Isolated Triac**

10 Amperes/400-600 Volts

**Absolute Maximum Ratings,  $T_a = 25\text{ }^\circ\text{C}$  unless otherwise specified**

Ratings	Symbol	BCR10PM-8	BCR10PM-12	Units
Repetitive Peak Off-state Voltage	$V_{DRM}$	400	600	Volts
Non-repetitive Peak Off-state Voltage	$V_{DSM}$	500	720	Volts
On-state Current, $T_c = 85^\circ\text{C}$	$I_{T(RMS)}$	10	10	Amperes
Non-repetitive Peak Surge, One Cycle (60 Hz)	$I_{TSM}$	100	100	Amperes
$I^2t$ for Fusing, $t = 8.3\text{ msec}$	$I^2t$	41.6	41.6	$\text{A}^2\text{sec}$
Peak Gate Power Dissipation, 20 $\mu\text{sec}$	$P_{GM}$	5	5	Watts
Average Gate Power Dissipation	$P_{G(avg)}$	0.5	0.5	Watts
Peak Gate Current	$I_{GM}$	2	2	Amperes
Peak Gate Voltage	$V_{GM}$	10	10	Volts
Storage Temperature	$T_{stg}$	-40 to 125	-40 to 125	$^\circ\text{C}$
Operating Junction Temperature	$T_j$	-40 to 125	-40 to 125	$^\circ\text{C}$
Isolation Voltage	$V_{iso}$	1500	1500	Volts
Weight	-	2	2	Grams



Powerex, Inc., 200 Hillis Street, Youngwood, Pennsylvania 15697-1800 (412) 925-7272

**BCR10PM**  
**Isolated Triac**  
 10 Amperes/400-600 Volts

**Electrical and Thermal Characteristics,  $T_j = 25\text{ }^\circ\text{C}$  unless otherwise specified**

Characteristics	Symbol	Test Conditions (Trigger Mode)				BCR10PM			Units
		$V_D$	$R_L$	$R_G$	$T_j$	Min.	Typ.	Max.	
Gate Parameters									
DC Gate Trigger Current									
MT2+ Gate+	$I_{GT}$	6V	6 $\Omega$	330 $\Omega$	25 $^\circ\text{C}$	–	–	30	mA
MT2+ Gate–		6V	6 $\Omega$	330 $\Omega$	25 $^\circ\text{C}$	–	–	30	mA
MT2– Gate–		6V	6 $\Omega$	330 $\Omega$	25 $^\circ\text{C}$	–	–	30	mA
DC Gate Trigger Voltage									
MT2+ Gate+	$V_{GT}$	6V	6 $\Omega$	330 $\Omega$	25 $^\circ\text{C}$	–	–	1.5	Volts
MT2+ Gate–		6V	6 $\Omega$	330 $\Omega$	25 $^\circ\text{C}$	–	–	1.5	Volts
MT2– Gate–		6V	6 $\Omega$	330 $\Omega$	25 $^\circ\text{C}$	–	–	1.5	Volts
DC Gate Non-trigger Voltage									
All	$V_{GD}$	1/2 $V_{DRM}$	–	–	125 $^\circ\text{C}$	0.2	–	–	Volts



Powerex, Inc., 200 Hillis Street, Youngwood, Pennsylvania 15697-1800 (412) 925-7272

**BCR10PM**

**Isolated Triac**

10 Amperes/400-600 Volts

**Electrical and Thermal Characteristics,  $T_j = 25\text{ }^\circ\text{C}$  unless otherwise specified**

Characteristics	Symbol	Test Conditions	Min.	Typ.	Max.	Units
Thermal Resistance, Junction-to-case	$R_{th(j-c)}$	–	–	–	3.5	$^\circ\text{C/W}$
Thermal Resistance, Junction-to-ambient	$R_{th(j-a)}$	–	–	–	60	$^\circ\text{C/W}$
Voltage – Blocking State Repetitive Off-state Current	$I_{DRM}$	Gate Open Circuited, $V_D = V_{DRM}$ , $T_j = 125^\circ\text{C}$	–	–	2.0	mA
Current – Conducting State Peak On-state Voltage	$V_{TM}$	$T_c = 25^\circ\text{C}$ , $I_{TM} = 15\text{A}$	–	–	1.5	Volts
Critical Rate-of-rise of Commutating Off-state Voltage (Commutating $dv/dt$ )	$(dv/dt)_c$	–	–	–	–	$\text{V}/\mu\text{s}$

▲ for inductive load (L)  
(Switching)

$\Delta$ Part Number	$V_{DRM}$ (Volts)	Commutating $dv/dt$ , $(dv/dt)_c$ ( $\text{V}/\mu\text{sec}$ )		Test Condition	Commutating Voltage & Current Waveform (Inductive Load)
		Minimum	Test Condition		
BCR10PM-8L	400	10	$T_j = 125^\circ\text{C}$ ,	Rate of Decay On-state Commutating Current $(di/dt)_c = -5\text{A/msec}$ ; Peak Off-state Voltage $V_D = 400\text{V}$	
BCR10PM-12L	600	10			



Powerex, Inc., 200 Hillis Street, Youngwood, Pennsylvania 15697-1800 (412) 925-7272

**BCR10PM**  
**Isolated Triac**  
 10 Amperes/400-600 Volts

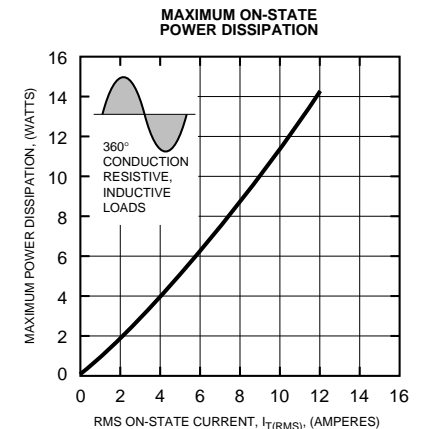
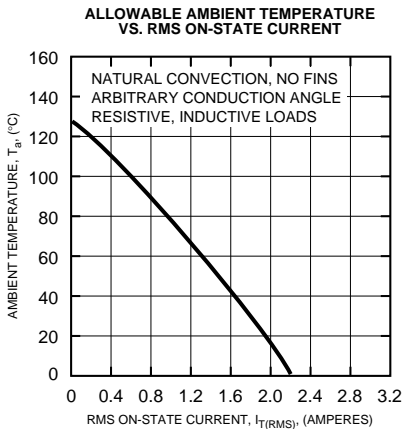
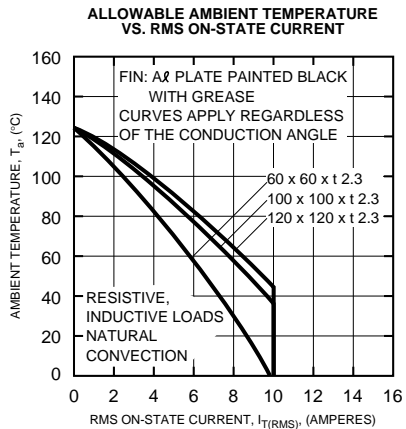
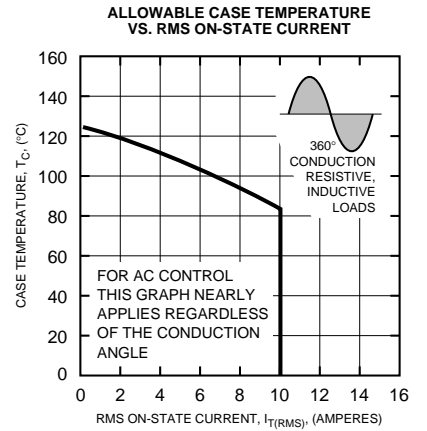
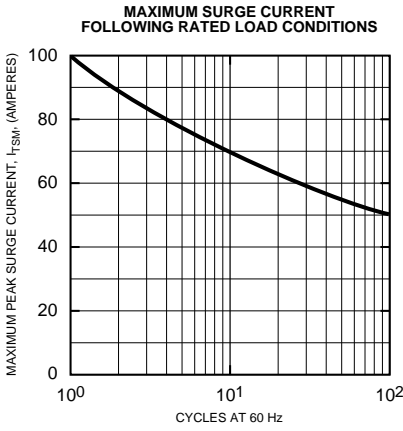
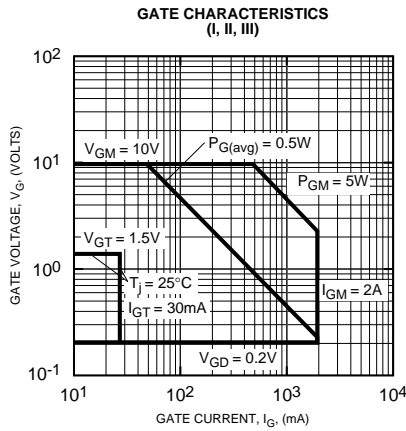
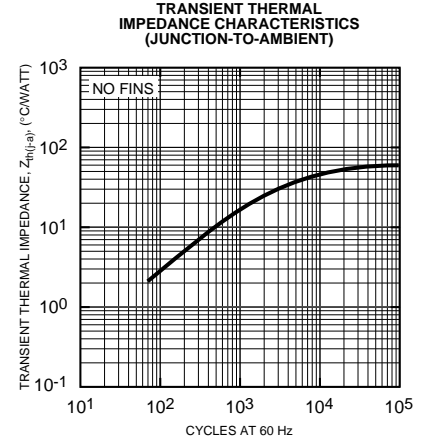
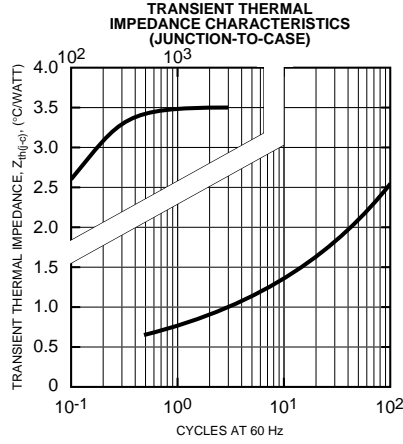
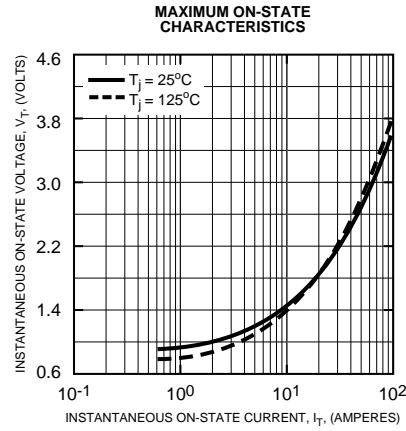



Powerex, Inc., 200 Hillis Street, Youngwood, Pennsylvania 15697-1800 (412) 925-7272

**BCR10PM**  
**Isolated Triac**  
 10 Amperes/400-600 Volts

**GATE TRIGGER CURRENT VS. JUNCTION TEMPERATURE (TYPICAL)**

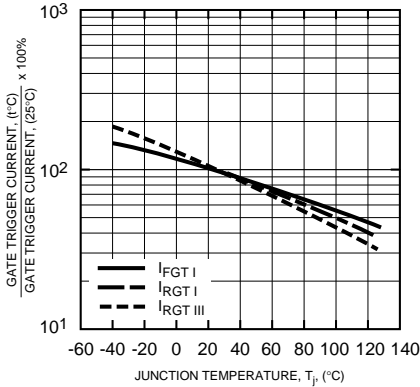

**GATE TRIGGER VOLTAGE VS. JUNCTION TEMPERATURE (TYPICAL)**

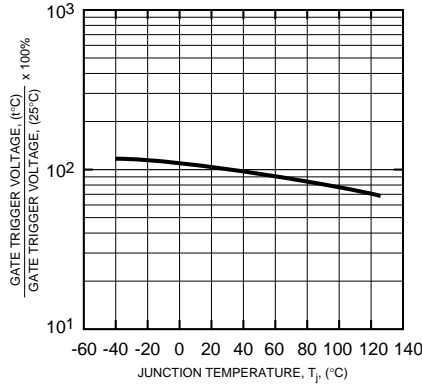

**LATCHING CURRENT VS. JUNCTION TEMPERATURE (TYPICAL)**

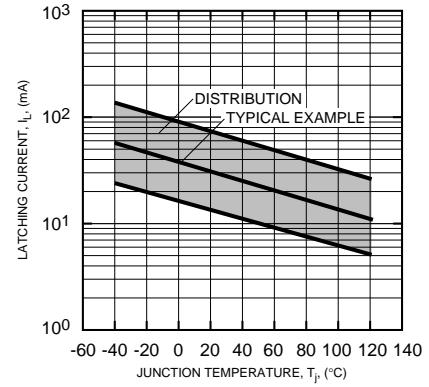

**BREAKOVER VOLTAGE VS. JUNCTION TEMPERATURE (TYPICAL)**

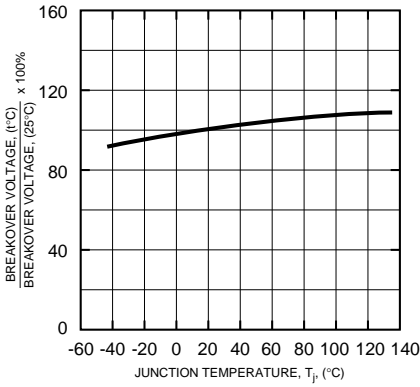

**BREAKOVER VOLTAGE VS. RATE OF RISE OF OFF-STATE VOLTAGE (TYPICAL)**

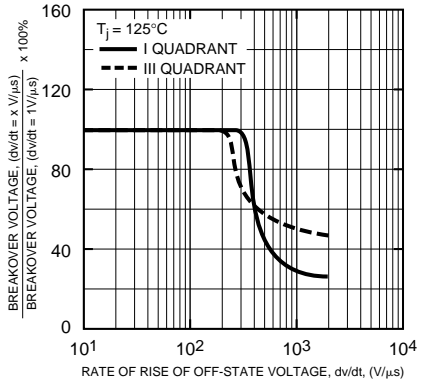

**REPETITIVE PEAK OFF-STATE CURRENT VS. JUNCTION TEMPERATURE (TYPICAL)**

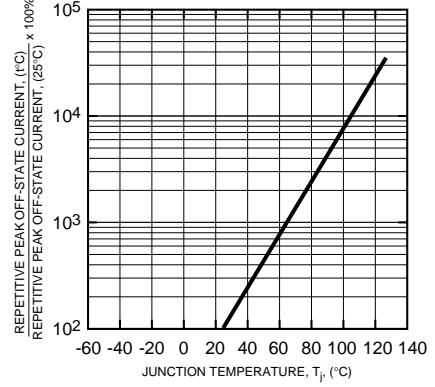

**COMMUTATION CHARACTERISTICS (TYPICAL)**

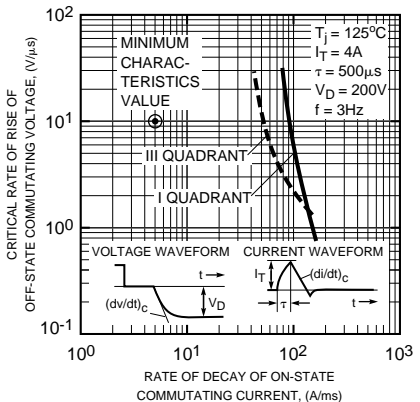

**GATE TRIGGER CURRENT VS. GATE CURRENT PULSE WIDTH (TYPICAL)**

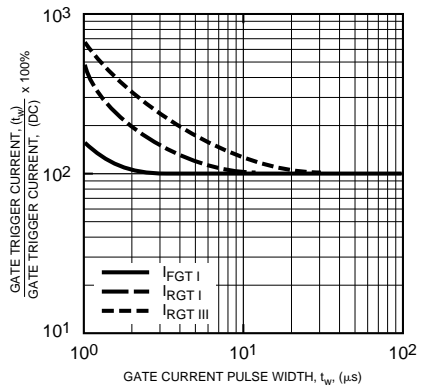

**GATE TRIGGER CHARACTERISTICS TEST CIRCUITS**

