

FAIRCHILD
SEMICONDUCTOR™

October 1987
Revised January 1999

CD4043BC • CD4044BC

Quad 3-STATE NOR R/S Latches • Quad 3-STATE NAND R/S Latches

General Description

The CD4043BC are quad cross-couple 3-STATE CMOS NOR latches, and the CD4044BC are quad cross-couple 3-STATE CMOS NAND latches. Each latch has a separate Q output and individual SET and RESET inputs. There is a common 3-STATE ENABLE input for all four latches. A logic "1" on the ENABLE input connects the latch states to the Q outputs. A logic "0" on the ENABLE input disconnects the latch states from the Q outputs resulting in an open circuit condition on the Q output. The 3-STATE feature allows common bussing of the outputs.

Features

- Wide supply voltage range: 3V to 15V
- Low power: 100 nW (typ.)
- High noise immunity: $0.45 V_{DD}$ (typ.)
- Separate SET and RESET inputs for each latch
- NOR and NAND configuration
- 3-STATE output with common output enable

Applications

- Multiple bus storage
- Strobed register
- Four bits of independent storage with output enable
- General digital logic

Ordering Code:

Order Number	Package Number	Package Description
CD4043BCM	M16A	16-Lead Small Outline Integrated Circuit (SOIC), JEDEC MS-012, 0.150" Narrow Body
CD4043BCN	N16E	16-Lead Plastic Dual-In-Line Package (PDIP), JEDEC MS-001, 0.300" Wide
CD4044BCM	M16A	16-Lead Small Outline Integrated Circuit (SOIC), JEDEC MS-012, 0.150" Narrow Body
CD4044BCSJ	M16D	16-Lead Small Outline Package (SOP), EIAJ TYPE II, 5.3mm Wide
CD4044BCN	N16E	16-Lead Plastic Dual-In-Line Package (PDIP), JEDEC MS-001, 0.300" Wide

Devices also available in Tape and Reel. Specify by appending the suffix letter "X" to the ordering code.

Connection Diagrams

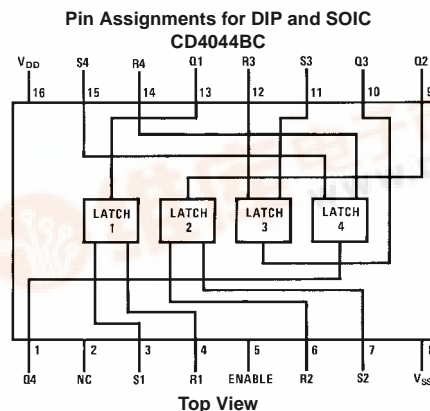
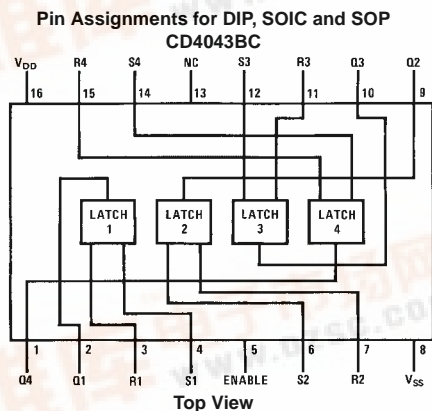

CD4043BC • CD4044BC Quad 3-STATE NOR R/S Latches • Quad 3-STATE NAND R/S Latches



Block Diagrams

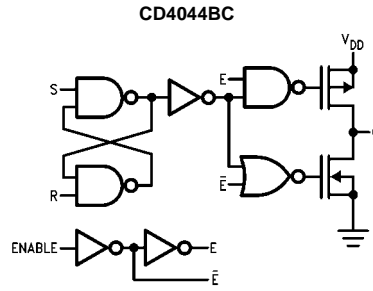
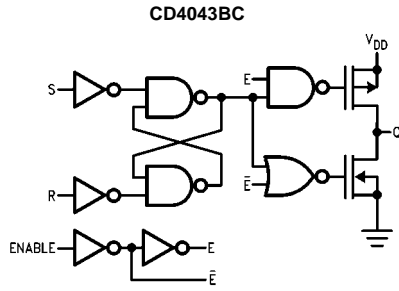

Truth Tables

CD4043BC

S	R	E	Q
X	X	0	OC
0	0	1	NC
1	0	1	1
0	1	1	0
1	1	1	Δ

CD4044BC

S	R	E	Q
X	X	0	OC
1	1	1	NC
0	1	1	1
1	0	1	0
0	0	1	ΔΔ

OC = 3-STATE
 NC = No change
 X = Don't care
 Δ = Dominated by S = 1 input
 ΔΔ = Dominated by R = 0 input

Absolute Maximum Ratings (Note 1)

(Note 2)

Supply Voltage (V_{DD})	-0.5V to +18V
Input Voltage (V_{IN})	-0.5V to $V_{DD} + 0.5V$
Storage Temperature Range (T_S)	-65°C to +150°C
Power Dissipation (P_D)	
Dual-In-Line	700 mW
Small Outline	500 mW
Lead Temperature (T_L)	
(Soldering, 10 seconds)	260°C

Recommended Operating Conditions

(Note 2)

Supply Voltage (V_{DD})	3.0V to 15V
Input Voltage (V_{IN})	0 to V_{DD} V
Operating Temperature Range (T_A)	
CD4043BC, CD4044BC	-40°C to +85°C

Note 1: "Absolute Maximum Ratings" are those values beyond which the safety of the device cannot be guaranteed; they are not meant to imply that the devices should be operated at these limits. The tables of "Recommended Operating Conditions" and "Electrical Characteristics" provide conditions for actual device operation.

Note 2: $V_{SS} = 0V$ unless otherwise specified.

DC Electrical Characteristics (Note 2)

Symbol	Parameter	Conditions	-40°C		+25°C			+85°C		Units
			Min	Max	Min	Typ	Max	Min	Max	
I_{DD}	Quiescent Device Current	$V_{DD} = 5V, V_{IN} = V_{DD}$ or V_{SS}		20		0.01	20		150	μA
		$V_{DD} = 10V, V_{IN} = V_{DD}$ or V_{SS}		40		0.01	40		300	μA
		$V_{DD} = 15V, V_{IN} = V_{DD}$ or V_{SS}		80		0.02	80		600	μA
V_{OL}	LOW Level Output Voltage	$ I_O \leq 1 \mu A, V_{IL} = 0V, V_{IH} = V_{DD}$								
		$V_{DD} = 5.0V$		0.05		0	0.05		0.05	V
		$V_{DD} = 10V$		0.05		0	0.05		0.05	V
		$V_{DD} = 15V$		0.05		0	0.05		0.05	V
V_{OH}	HIGH Level Output Voltage	$ I_O \leq 1 \mu A, V_{IL} = 0V, V_{IH} = V_{DD}$								
		$V_{DD} = 5.0V$	4.95		4.95	5.0		4.95		V
		$V_{DD} = 10V$	9.95		9.95	10		9.95		V
		$V_{DD} = 15V$	14.95		14.95	15		14.95		V
V_{IL}	LOW Level Input Voltage	$ I_O \leq 1 \mu A$								
		$V_{DD} = 5.0V, V_O = 0.5V$ or $4.5V$		1.5		2.25	1.5		1.5	V
		$V_{DD} = 10V, V_O = 1.0V$ or $9.0V$		3.0		4.5	3.0		3.0	V
		$V_{DD} = 15V, V_O = 1.5V$ or $13.5V$		4.0		6.75	4.0		4.0	V
V_{IH}	HIGH Level Input Voltage	$ I_O \leq 1 \mu A$								
		$V_{DD} = 5.0V, V_O = 0.5V$ or $4.5V$	3.5		3.5			3.5		V
		$V_{DD} = 10V, V_O = 1.0V$ or $9.0V$	7.0		7.0			7.0		V
		$V_{DD} = 15V, V_O = 1.5V$ or $13.5V$	11		11			11		V
I_{OL}	LOW Level Output Current (Note 3)	$V_{IL} = 0V, V_{IH} = V_{DD}$								
		$V_{DD} = 5.0V, V_O = 0.4V$	0.52		0.44	0.88		0.36		mA
		$V_{DD} = 10V, V_O = 0.5V$	1.3		1.1	2.2		0.9		mA
		$V_{DD} = 15V, V_O = 1.5V$	3.6		3.0	6.0		2.4		mA
I_{OH}	HIGH Level Output Current (Note 3)	$V_{IL} = 0V, V_{IH} = V_{DD}$								
		$V_{DD} = 5.0V, V_O = 4.6V$	-0.52		-0.44	-0.32		-0.36		mA
		$V_{DD} = 10V, V_O = 9.5V$	-1.3		-1.1	-0.8		-0.9		mA
		$V_{DD} = 15V, V_O = 13.5V$	-3.6		-3.0	-2.4		-2.4		mA
I_{IN}	Input Current	$V_{DD} = 15V, V_{IN} = 0V$	-0.3			-0.3			-1.0	μA
		$V_{DD} = 15V, V_{IN} = 15V$	0.3			0.3			1.0	μA

Note 3: I_{OH} and I_{OL} are tested one output at a time.

AC Electrical Characteristics (Note 4)

$T_A = 25^\circ\text{C}$, $C_L = 50\text{ pF}$, $R_L = 200\text{ k}$, input $t_r = t_f = 20\text{ ns}$, unless otherwise noted

Symbol	Parameter	Conditions	Min	Typ	Max	Units
t_{PLH}, t_{PHL}	Propagation Delay S or R to Q	$V_{DD} = 5.0\text{V}$ $V_{DD} = 10\text{V}$ $V_{DD} = 15\text{V}$		175 75 60	350 175 120	ns
t_{PZH}, t_{PHZ}	Propagation Delay Enable to Q (HIGH)	$V_{DD} = 5.0\text{V}$ $V_{DD} = 10\text{V}$ $V_{DD} = 15\text{V}$		115 55 40	230 110 80	ns
t_{PZL}, t_{PLZ}	Propagation Delay Enable to Q (LOW)	$V_{DD} = 5.0\text{V}$ $V_{DD} = 10\text{V}$ $V_{DD} = 15\text{V}$		100 50 40	200 100 80	ns
t_{THL}, t_{TLH}	Transition Time	$V_{DD} = 5.0\text{V}$ $V_{DD} = 10\text{V}$ $V_{DD} = 15\text{V}$		100 50 40	200 100 80	ns
t_{WO}	Minimum SET or RESET Pulse Width	$V_{DD} = 5.0\text{V}$ $V_{DD} = 10\text{V}$ $V_{DD} = 15\text{V}$		80 40 20	160 80 40	ns
C_{IN}	Input Capacitance			5.0	7.5	pF

Note 4: AC Parameters are guaranteed by DC correlated testing.

Timing Waveforms

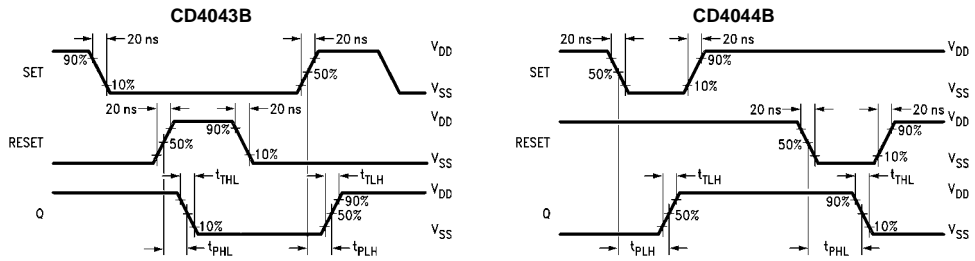

Enable Timing

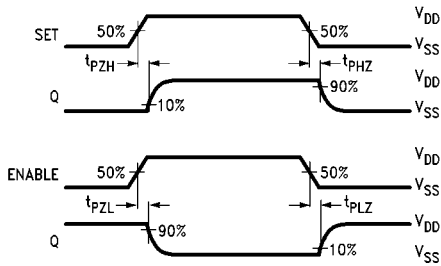

Physical Dimensions inches (millimeters) unless otherwise noted

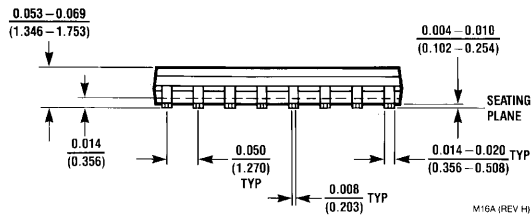
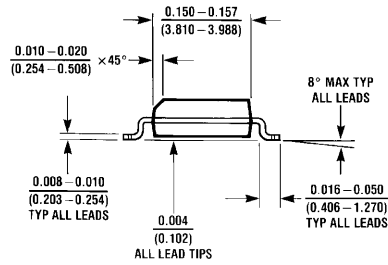
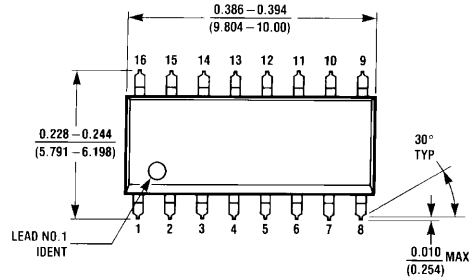

**16-Lead Small Outline Integrated Circuit (SOIC), JEDEC MS-012, 0.150" Narrow Body
Package Number M16A**

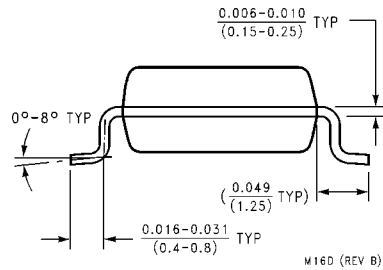
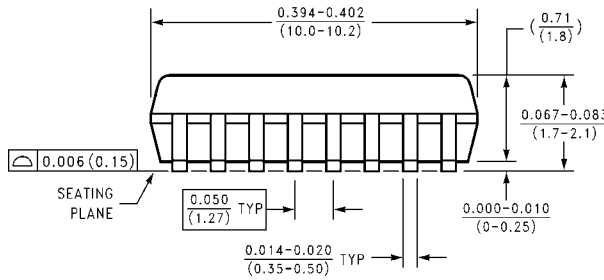
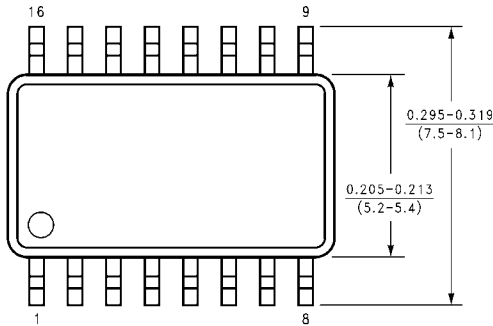

**16-Lead Small Outline Package (SOP), EIAJ TYPE II, 5.3mm Wide
Package Number M16D**

Physical Dimensions inches (millimeters) unless otherwise noted (Continued)

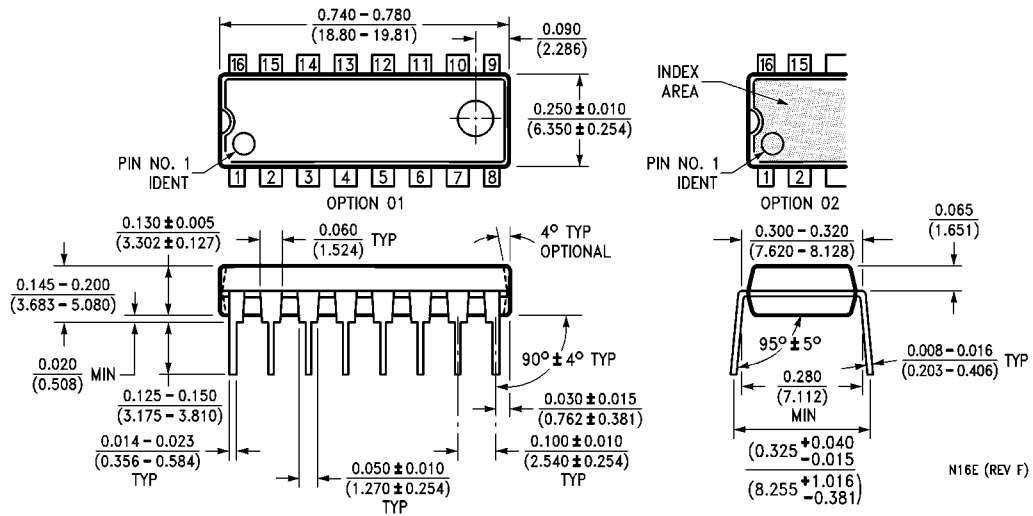

16-Lead Plastic Dual-In-Line Package (PDIP), JEDEC MS-001, 0.300" Wide Package Number N16E

N16E (REV F)

LIFE SUPPORT POLICY

FAIRCHILD'S PRODUCTS ARE NOT AUTHORIZED FOR USE AS CRITICAL COMPONENTS IN LIFE SUPPORT DEVICES OR SYSTEMS WITHOUT THE EXPRESS WRITTEN APPROVAL OF THE PRESIDENT OF FAIRCHILD SEMICONDUCTOR CORPORATION. As used herein:

1. Life support devices or systems are devices or systems which, (a) are intended for surgical implant into the body, or (b) support or sustain life, and (c) whose failure to perform when properly used in accordance with instructions for use provided in the labeling, can be reasonably expected to result in a significant injury to the user.
2. A critical component in any component of a life support device or system whose failure to perform can be reasonably expected to cause the failure of the life support device or system, or to affect its safety or effectiveness.

www.fairchildsemi.com