

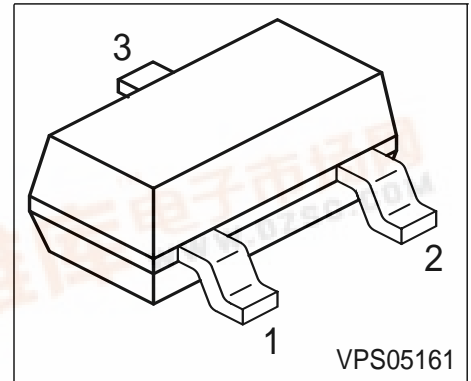

BCW65, BCW66

NPN Silicon AF Transistor

- For general AF applications
- High current gain
- Low collector-emitter saturation voltage
- Complementary types: BCW67, BCW68 (PNP)



Type	Marking	Pin Configuration			Package
BCW65A	EAs	1 = B	2 = E	3 = C	SOT23
BCW65B	EBs	1 = B	2 = E	3 = C	SOT23
BCW65C	ECs	1 = B	2 = E	3 = C	SOT23
BCW66F	EFs	1 = B	2 = E	3 = C	SOT23
BCW66G	EGs	1 = B	2 = E	3 = C	SOT23
BCW66H	EHs	1 = B	2 = E	3 = C	SOT23

Maximum Ratings

Parameter	Symbol	BCW65	BCW66	Unit
Collector-emitter voltage	V_{CEO}	32	45	V
Collector-base voltage	V_{CBO}	60	75	
Emitter-base voltage	V_{EBO}	5	5	
DC collector current	I_C	800		mA
Peak collector current	I_{CM}	1		A
Base current	I_B	100		mA
Peak base current	I_{BM}	200		
Total power dissipation, $T_S = 79\text{ °C}$	P_{tot}	330		mW
Junction temperature	T_j	150		°C
Storage temperature	T_{stg}	-65 ... 150		

Thermal Resistance

Junction - soldering point ¹⁾	R_{thJS}	≤215	K/W
--	------------	------	-----

¹⁾For calculation of R_{thJA} please refer to Application Note Thermal Resistance

Electrical Characteristics at $T_A = 25^\circ\text{C}$, unless otherwise specified.

Parameter	Symbol	Values			Unit
		min.	typ.	max.	
DC Characteristics					
Collector-emitter breakdown voltage $I_C = 10\text{ mA}, I_B = 0$	$V_{(BR)CEO}$				V
BCW65		32	-	-	
BCW66		45	-	-	
Collector-base breakdown voltage $I_C = 10\ \mu\text{A}, I_B = 0$	$V_{(BR)CBO}$				
BCW65		60	-	-	
BCW66		75	-	-	
Emitter-base breakdown voltage $I_E = 10\ \mu\text{A}, I_C = 0$	$V_{(BR)EBO}$	5	-	-	
Collector cutoff current $V_{CB} = 32\text{ V}, I_E = 0$	I_{CBO}				nA
BCW65		-	-	20	
$V_{CB} = 45\text{ V}, I_E = 0$					
BCW66		-	-	20	
Collector cutoff current $V_{CB} = 32\text{ V}, I_E = 0, T_A = 150^\circ\text{C}$	I_{CBO}				μA
BCW65		-	-	20	
$V_{CB} = 45\text{ V}, I_E = 0, T_A = 150^\circ\text{C}$					
BCW66		-	-	20	
Emitter cutoff current $V_{EB} = 4\text{ V}, I_C = 0$	I_{EBO}	-	-	20	nA
DC current gain 1) $I_C = 100\ \mu\text{A}, V_{CE} = 10\text{ V}$	h_{FE}				-
h_{FE} -grp. A/F		35	-	-	
h_{FE} -grp. B/G		50	-	-	
h_{FE} -grp. C/H		80	-	-	
DC current gain 1) $I_C = 10\text{ mA}, V_{CE} = 1\text{ V}$	h_{FE}				
h_{FE} -grp. A/F		75	-	-	
h_{FE} -grp. B/G		110	-	-	
h_{FE} -grp. C/H		180	-	-	
DC current gain 1) $I_C = 100\text{ mA}, V_{CE} = 1\text{ V}$	h_{FE}				
h_{FE} -grp. A/F		100	160	250	
h_{FE} -grp. B/G		160	250	400	
h_{FE} -grp. C/H		250	350	630	

 1) Pulse test: $t \leq 300\ \mu\text{s}$, $D = 2\%$

Electrical Characteristics at $T_A = 25^\circ\text{C}$, unless otherwise specified.

Parameter	Symbol	Values			Unit
		min.	typ.	max.	
DC Characteristics					
DC current gain 1) $I_C = 500\text{ mA}$, $V_{CE} = 2\text{ V}$	h_{FE} $h_{FE}\text{-grp. A/F}$ $h_{FE}\text{-grp. B/G}$ $h_{FE}\text{-grp. C/H}$	- - -	35 60 100	- - -	-
Collector-emitter saturation voltage1) $I_C = 100\text{ mA}$, $I_B = 10\text{ mA}$ $I_C = 500\text{ mA}$, $I_B = 50\text{ mA}$	V_{CEsat}	- -	- -	0.3 0.7	V
Base-emitter saturation voltage 1) $I_C = 100\text{ mA}$, $I_B = 10\text{ mA}$ $I_C = 500\text{ mA}$, $I_B = 50\text{ mA}$	V_{BEsat}	- -	- -	1.25 2	
AC Characteristics					
Transition frequency $I_C = 50\text{ mA}$, $V_{CE} = 5\text{ V}$, $f = 20\text{ MHz}$	f_T	-	170	-	MHz
Collector-base capacitance $V_{CB} = 10\text{ V}$, $f = 1\text{ MHz}$	C_{cb}	-	6	-	pF
Emitter-base capacitance $V_{EB} = 0.5\text{ V}$, $f = 1\text{ MHz}$	C_{eb}	-	60	-	

Total power dissipation $P_{tot} = f(T_S)$

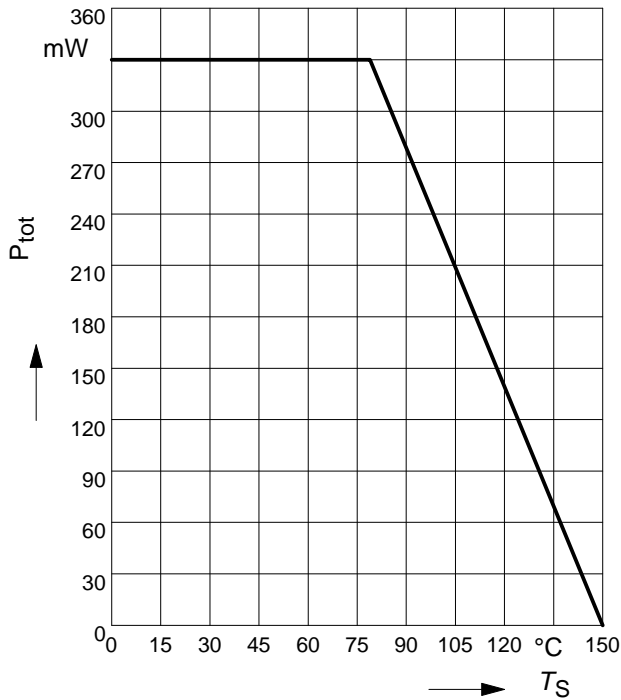

Transition frequency $f_T = f(I_C)$

$V_{CE} = 5V$

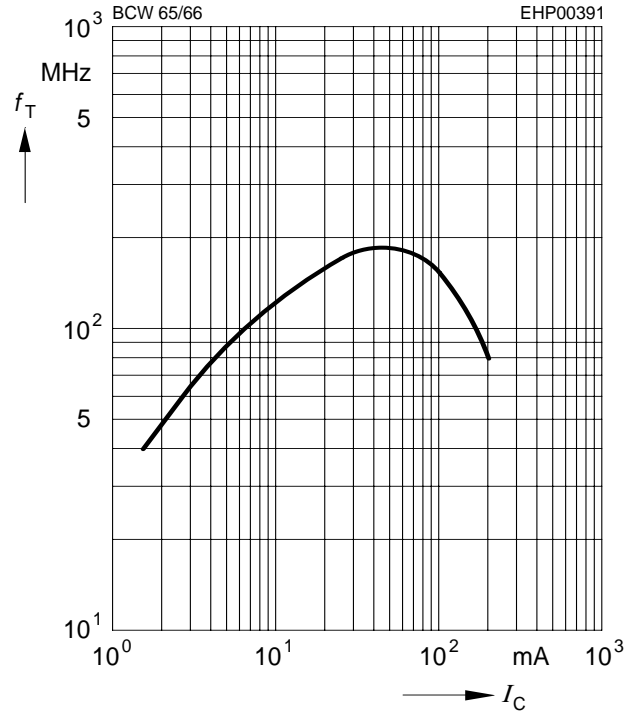

Permissible pulse load

$P_{totmax} / P_{totDC} = f(t_p)$

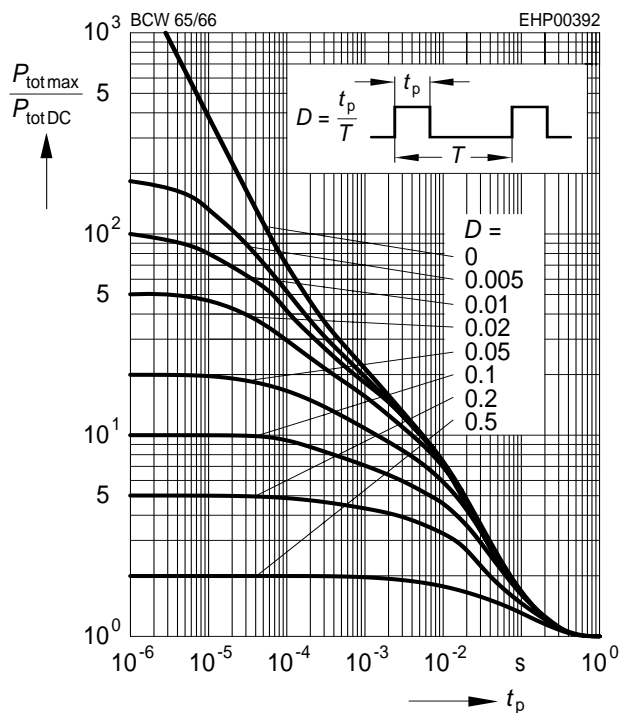

Collector cutoff current $I_{CBO} = f(T_A)$

$V_{CB} = V_{CEmax}$

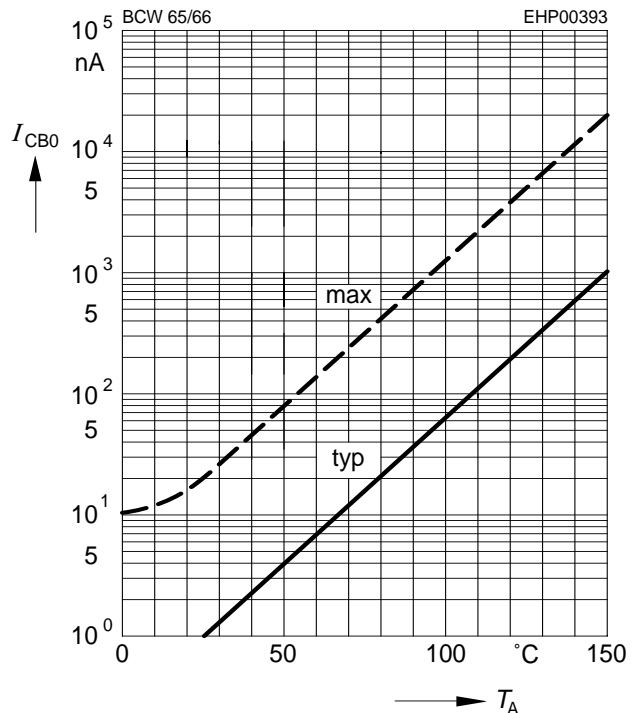

Base-emitter saturation voltage

$I_C = f(V_{BEsat}), h_{FE} = 10$

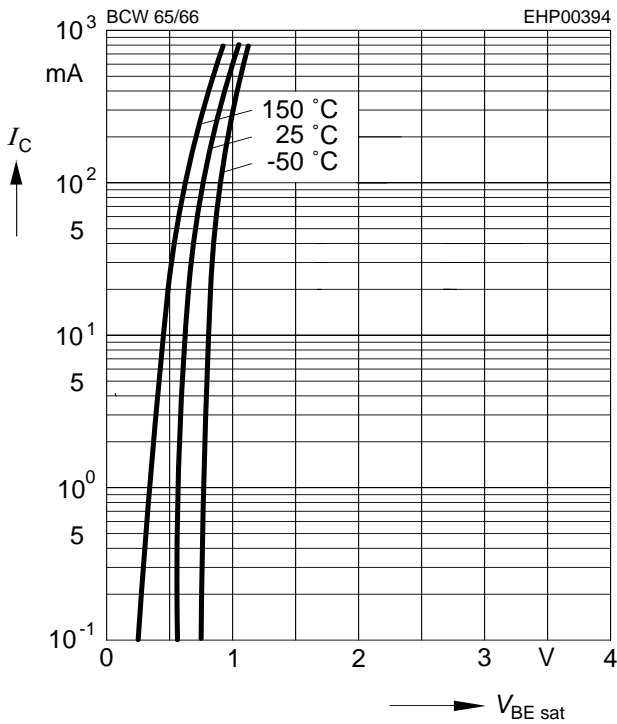

Collector-emitter saturation voltage

$I_C = f(V_{CEsat}), h_{FE} = 10$

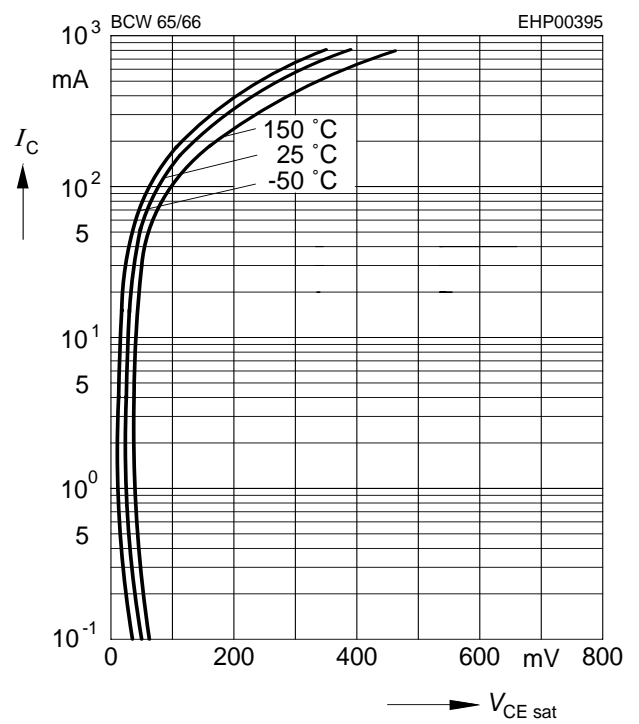

DC current gain $h_{FE} = f(I_C)$

$V_{CE} = 1V$

