

ST MOSPEC

COMPLEMENTARY SILICON PLASTIC POWER TRANSISTORS

... designed for use in general purpose power amplifier and switching applications.

FEATURES:

- * Collector-Emitter Sustaining Voltage - $V_{CE(sus)}$ = 45V(Min)- BD243,BD244
60V(Min)- BD243A,BD244A
80V(Min)- BD243B,BD244B
100V(Min)- BD243C,BD244C
- * DC Current Gain $hFE = 30(\text{Min}) @ I_C = 0.3A$
- * Current Gain-Bandwidth Product $fT = 3.0 \text{ MHz} (\text{Min}) @ I_C = 500\text{mA}$

MAXIMUM RATINGS

Characteristic	Symbol	BD243	BD243A	BD243B	BD243C	Unit
		BD244	BD244A	BD244B	BD244C	
Collector-Emitter Voltage	V_{CEO}	45	60	80	100	V
Collector-Base Voltage	V_{CBO}	45	60	80	100	V
Emitter-Base Voltage	V_{EBO}	5.0				V
Collector Current - Continuous - Peak	I_C	6.0 10				A
Base Current	I_B	2.0				A
Total Power Dissipation @ $T_C = 25^\circ\text{C}$ Derate above 25°C	P_D	65 0.52				W W/ $^\circ\text{C}$
Operating and Storage Junction Temperature Range	T_J, T_{STG}	-65 to +150				$^\circ\text{C}$

THERMAL CHARACTERISTICS

Characteristic	Symbol	Max	Unit
Thermal Resistance Junction to Case	$R_{\theta jc}$	1.92	$^\circ\text{C/W}$

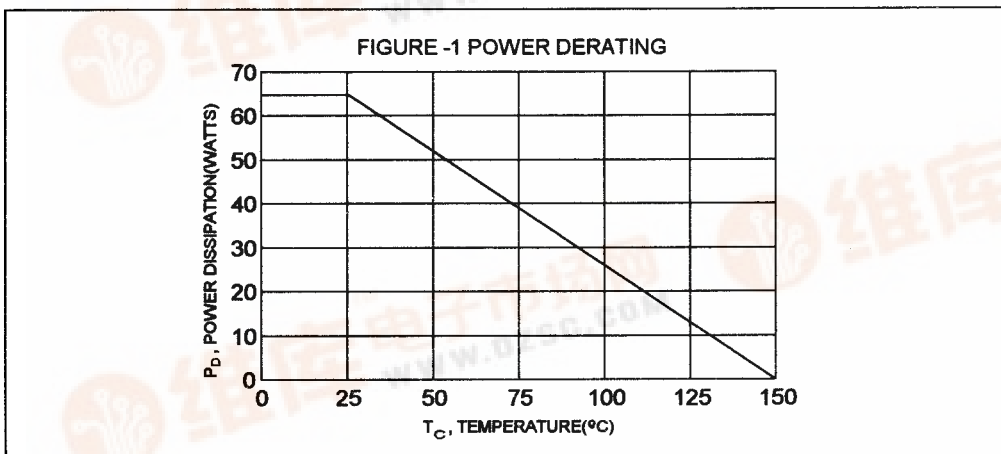

NPN	PNP
BD243	BD244
BD243A	BD244A
BD243B	BD244B
BD243C	BD244C

6 AMPERE
COMPLEMENTARY SILICON
POWER TRANSISTORS
45 -100 VOLTS
65 WATTS

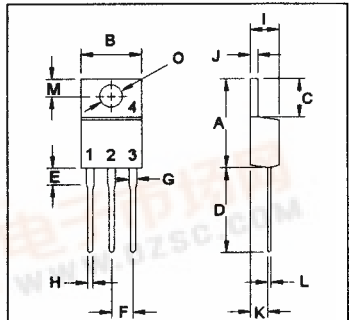
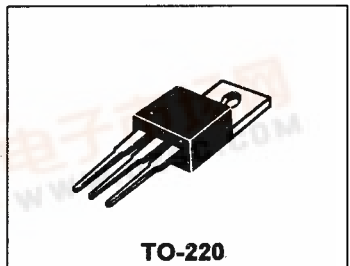

PIN 1.BASE
2.COLLECTOR
3.EMITTER
4.COLLECTOR(CASE)

DIM	MILLIMETERS	
	MIN	MAX
A	14.68	15.31
B	9.78	10.42
C	5.01	6.52
D	13.06	14.62
E	3.57	4.07
F	2.42	3.66
G	1.12	1.36
H	0.72	0.96
I	4.22	4.98
J	1.14	1.38
K	2.20	2.97
L	0.33	0.55
M	2.48	2.98
O	3.70	3.90

BD243,A,B,C NPN / BD244,A,B,C PNP

ELECTRICAL CHARACTERISTICS ($T_C = 25^\circ\text{C}$ unless otherwise noted)

Characteristic	Symbol	Min	Max	Unit
----------------	--------	-----	-----	------

OFF CHARACTERISTICS

Collector-Emitter Sustaining Voltage(1) ($I_C = 30\text{ mA}$, $I_B = 0$)	BD243, BD244 BD243A, BD244A BD243B, BD244B BD243C, BD244C	$V_{CE(sus)}$	45 60 80 100	V
Collector Cutoff Current ($V_{CE} = 30\text{ V}$, $I_B = 0$) ($V_{CE} = 60\text{ V}$, $I_B = 0$)	BD243/44/43A/44A BD243B/44B/43C/44C	I_{CEO}	0.7 0.7	mA
Collector Cutoff Current ($V_{CE} = 45\text{ V}$, $V_{EB} = 0$) ($V_{CE} = 60\text{ V}$, $V_{EB} = 0$) ($V_{CE} = 80\text{ V}$, $V_{EB} = 0$) ($V_{CE} = 100\text{ V}$, $V_{EB} = 0$)	BD243/44 BD243A/44A BD243B/44B BD243C/44C	I_{CES}	0.4 0.4 0.4 0.4	mA
Emitter Cutoff Current ($V_{EB} = 5.0\text{ V}$, $I_C = 0$)		I_{EBO}	1.0	mA

ON CHARACTERISTICS (1)

DC Current Gain ($V_{CE} = 4.0\text{ V}$, $I_C = 0.3\text{ A}$) ($V_{CE} = 4.0\text{ V}$, $I_C = 3.0\text{ A}$)		h_{FE}	30 15	
Collector-Emitter Saturation Voltage ($I_C = 6.0\text{ A}$, $I_B = 1.0\text{ A}$)		$V_{CE(sat)}$	1.5	V
Base-Emitter On Voltage ($I_C = 6.0\text{ A}$, $V_{CE} = 4.0\text{ V}$)		$V_{BE(on)}$	2.0	V

DYNAMIC CHARACTERISTICS

Current Gain-Bandwidth Product (2) ($I_C = 500\text{ mA}$, $V_{CE} = 10\text{ V}$, $f = 1\text{ MHz}$)		f_T	3.0	MHz
Small-Signal Current Gain ($I_C = 500\text{ mA}$, $V_{CE} = 10\text{ V}$, $f = 1\text{ KHz}$)		h_{fe}	20	

(1) Pulse Test: Pulse width = $300\ \mu\text{s}$, Duty Cycle $\leq 2.0\%$

(2) $f_T = |h_{fe}| \cdot f_{test}$

DC CURRENT GAIN

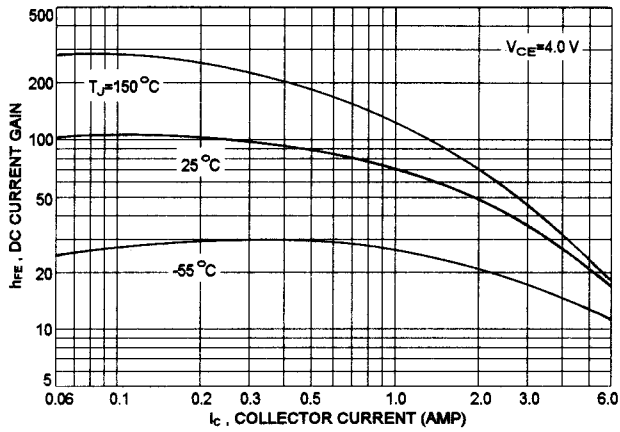

COLLECTOR SATURATION REGION

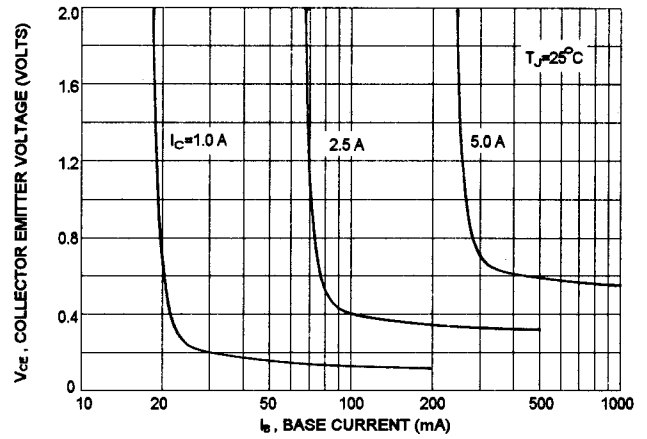

TURN-ON TIME

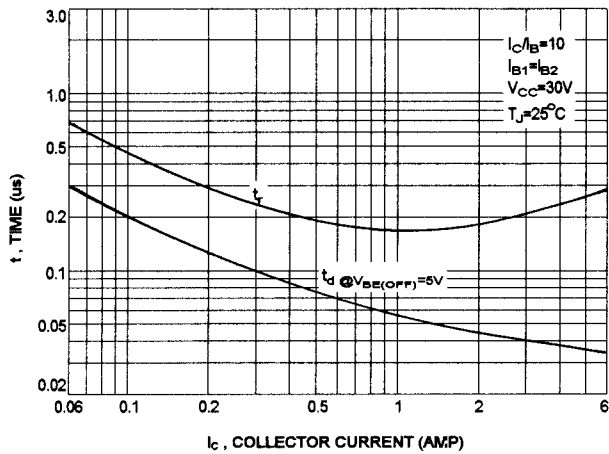

TURN-OFF TIME

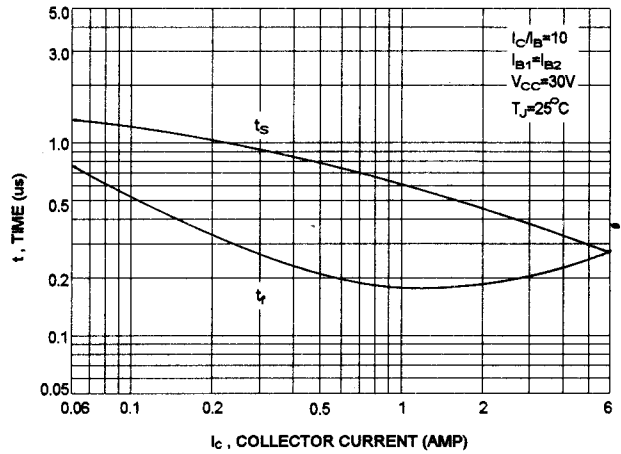

"ON" VOLTAGES

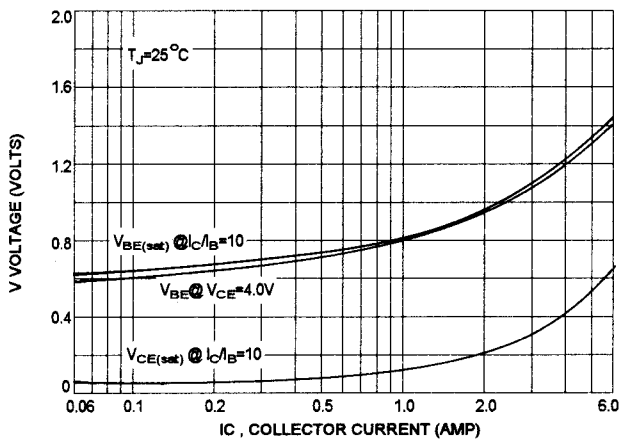

ACTIVE REGION SAFE OPERATING AREA

