

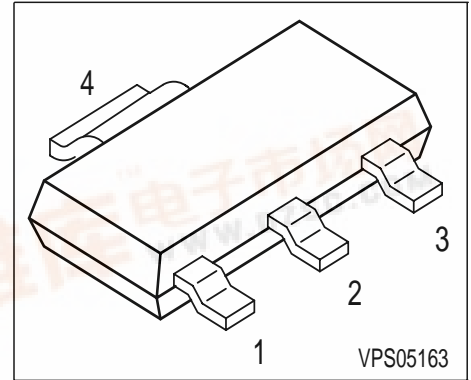

BDP951 ... BDP955

NPN Silicon AF Power Transistor

- For AF driver and output stages
- High collector current
- High current gain
- Low collector-emitter saturation voltage
- Complementary types: BDP952 ... BDP956 (PNP)



Type	Marking	Pin Configuration				Package
BDP951	BDP 951	1 = B	2 = C	3 = E	4 = C	SOT223
BDP953	BDP 953	1 = B	2 = C	3 = E	4 = C	SOT223
BDP955	PDP 955	1 = B	2 = C	3 = E	4 = C	SOT223

Maximum Ratings

Parameter	Symbol	BDP 951	BDP 953	BDP 955	Unit
Collector-emitter voltage	V_{CEO}	80	100	120	V
Collector-base voltage	V_{CBO}	100	120	140	
Emitter-base voltage	V_{EBO}	5	5	5	
DC collector current	I_C	3			A
Peak collector current	I_{CM}	5			
Base current	I_B	200			mA
Peak base current	I_{BM}	500			
Total power dissipation, $T_S = 99\text{ °C}$	P_{tot}	3			W
Junction temperature	T_j	150			°C
Storage temperature	T_{stg}	-65 ... 150			

Thermal Resistance

Junction - soldering point ¹⁾	R_{thJS}	≤17	K/W
--	------------	-----	-----

¹⁾For calculation of R_{thJA} please refer to Application Note Thermal Resistance

Electrical Characteristics at $T_A = 25^\circ\text{C}$, unless otherwise specified.

Parameter	Symbol	Values			Unit
		min.	typ.	max.	
DC Characteristics					
Collector-emitter breakdown voltage $I_C = 10\text{ mA}, I_B = 0$	$V_{(BR)CEO}$				V
BDP951		80	-	-	
BDP953		100	-	-	
BDP955		120	-	-	
Collector-base breakdown voltage $I_C = 100\ \mu\text{A}, I_B = 0$	$V_{(BR)CBO}$				
BDP951		100	-	-	
BDP953		120	-	-	
BDP955		140	-	-	
Emitter-base breakdown voltage $I_E = 10\ \mu\text{A}, I_C = 0$	$V_{(BR)EBO}$	5	-	-	
Collector cutoff current $V_{CB} = 100\text{ V}, I_E = 0$	I_{CBO}	-	-	100	nA
Collector cutoff current $V_{CB} = 100\text{ V}, I_E = 0, T_A = 150\ ^\circ\text{C}$	I_{CBO}	-	-	20	μA
Emitter cutoff current $V_{EB} = 4\text{ V}, I_C = 0$	I_{EBO}	-	-	100	nA
DC current gain 1) $I_C = 10\text{ mA}, V_{CE} = 5\text{ V}$ $I_C = 500\text{ mA}, V_{CE} = 1\text{ V}$ $I_C = 2\text{ A}, V_{CE} = 2\text{ V}$	h_{FE}	25 40 15	- - -	- 475 -	-
Collector-emitter saturation voltage1) $I_C = 2\text{ A}, I_B = 0.2\text{ A}$	V_{CEsat}	-	-	0.8	V
Base-emitter saturation voltage 1) $I_C = 2\text{ A}, I_B = 0.2\text{ A}$	V_{BEsat}	-	-	1.5	
AC Characteristics					
Transition frequency $I_C = 50\text{ mA}, V_{CE} = 10\text{ V}, f = 100\text{ MHz}$	f_T	-	100	-	MHz
Collector-base capacitance $V_{CB} = 10\text{ V}, f = 1\text{ MHz}$	C_{cb}	-	25	-	pF

 1) Pulse test: $t \leq 300\ \mu\text{s}$, $D = 2\%$

Total power dissipation $P_{tot} = f(T_S)$

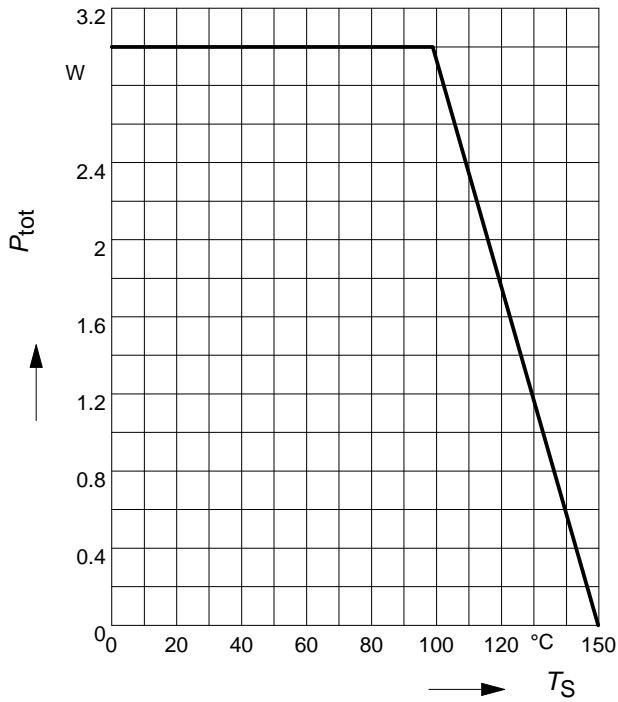

Permissible Pulse Load $R_{thJS} = f(t_p)$

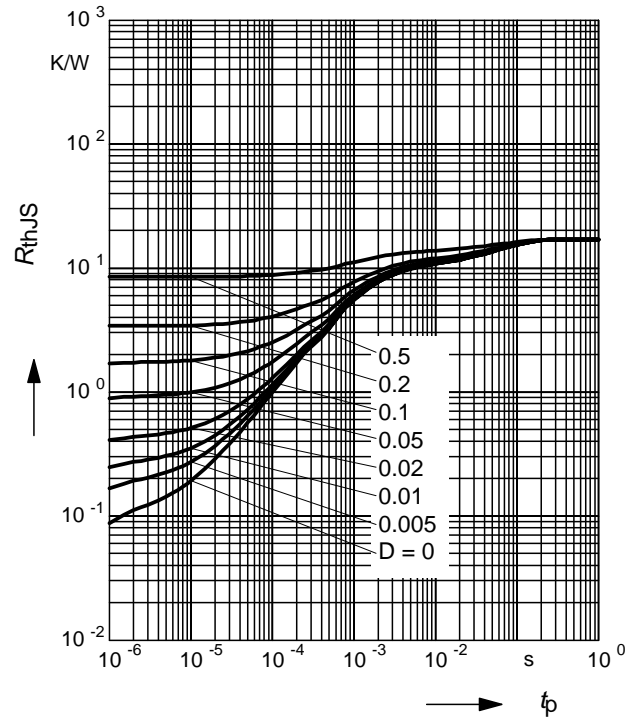

Permissible Pulse Load

$$P_{totmax} / P_{totDC} = f(t_p)$$

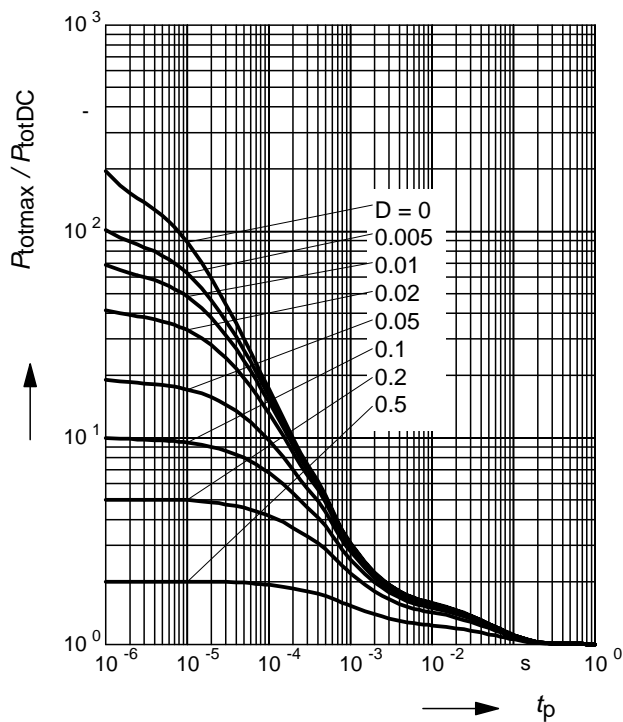

DC current gain $h_{FE} = f(I_C)$

$$V_{CE} = 2V$$

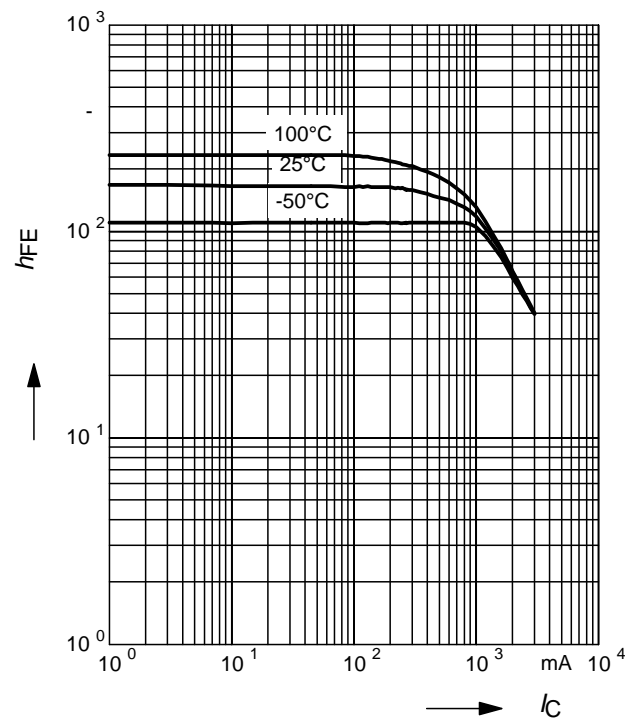

Collector cutoff current $I_{CBO} = f(T_A)$

$V_{CB} = 45V$

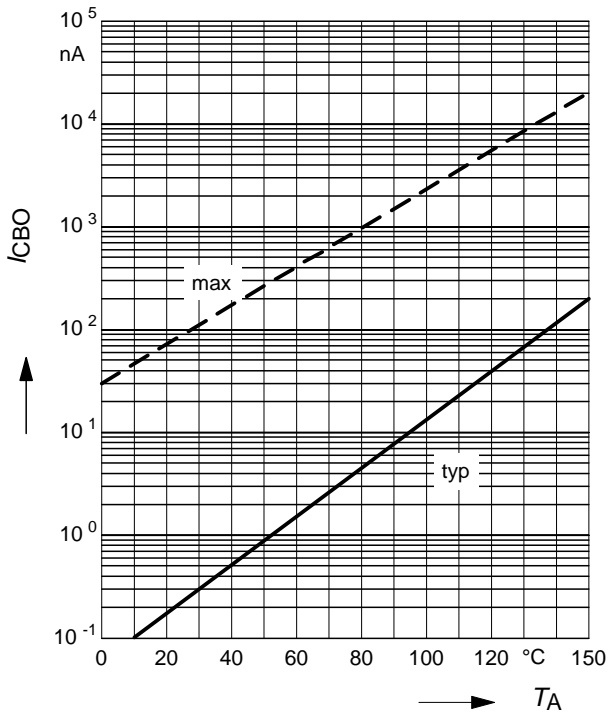

Collector-emitter saturation voltage

$I_C = f(V_{CEsat}), h_{FE} = 10$

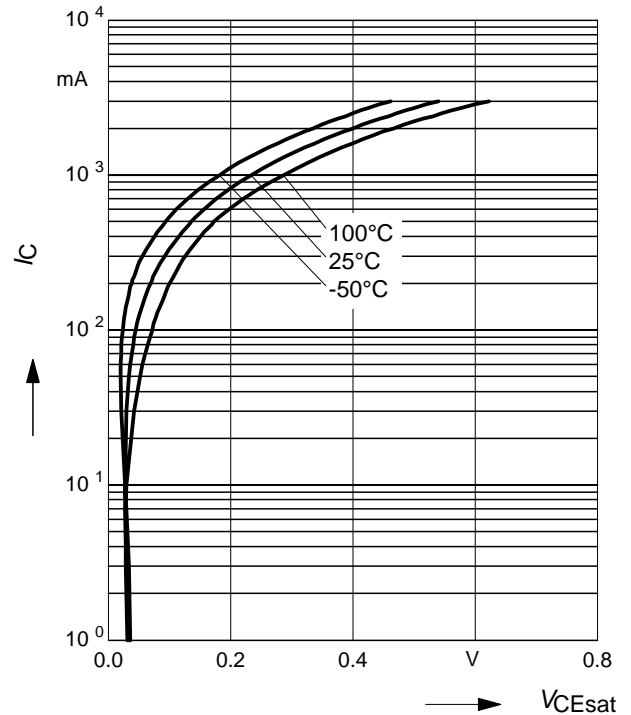

Base-emitter saturation voltage

$I_C = f(V_{BEsat}), h_{FE} = 10$

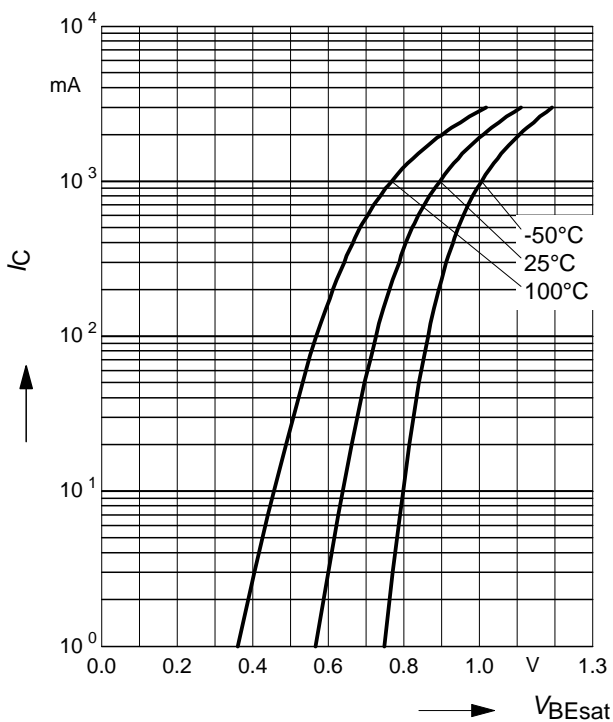

Collector current $I_C = f(V_{BE})$

$V_{CE} = 2V$

