

SIEMENS

BFG 194

PNP Silicon RF Transistor

- For low distortion broadband amplifiers in antenna and telecommunications systems up to 1.5 GHz at collector currents from 20mA to 80mA

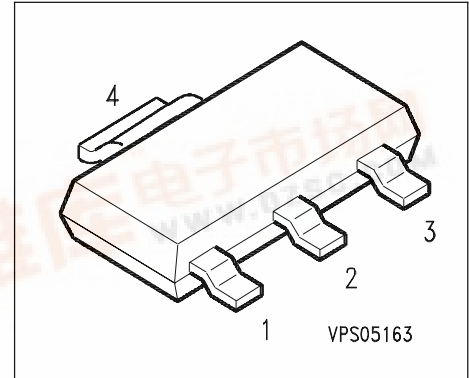

ESD: Electrostatic discharge sensitive device, observe handling precaution!

Type	Marking	Ordering Code	Pin Configuration				Package
BFG 194	BFG194	Q62702-F1321	1 = E	2 = B	3 = E	4 = C	SOT-223

Maximum Ratings

Parameter	Symbol	Values	Unit
Collector-emitter voltage	V_{CEO}	15	V
Collector-base voltage	V_{CBO}	20	
Emitter-base voltage	V_{EBO}	3	
Collector current	I_C	100	mA
Base current	I_B	10	
Total power dissipation $T_S \leq 75\text{ }^\circ\text{C}$	P_{tot}	1000	mW
Junction temperature	T_j	150	$^\circ\text{C}$
Ambient temperature	T_A	- 65 ... + 150	
Storage temperature	T_{stg}	- 65 ... + 150	

Thermal Resistance

Junction - soldering point ¹⁾	R_{thJS}	≤ 75	K/W
--	------------	-----------	-----

1) T_S is measured on the collector lead at the soldering point to the pcb.

Electrical Characteristics at $T_A = 25^\circ\text{C}$, unless otherwise specified.

Parameter	Symbol	Values			Unit
		min.	typ.	max.	
DC Characteristics					
Collector-emitter breakdown voltage $I_C = 1 \text{ mA}, I_B = 0$	$V_{(BR)CEO}$	15	-	-	V
Collector-base cutoff current $V_{CB} = 10 \text{ V}, I_E = 0$	I_{CBO}	-	-	100	nA
Emitter-base cutoff current $V_{EB} = 2 \text{ V}, I_C = 0$	I_{EBO}	-	-	1	μA
DC current gain $I_C = 70 \text{ mA}, V_{CE} = 8 \text{ V}$	h_{FE}	15	50	-	-

Electrical Characteristics at $T_A = 25^\circ\text{C}$, unless otherwise specified.

Parameter	Symbol	Values			Unit
		min.	typ.	max.	
AC Characteristics					
Transition frequency $I_C = 70\text{ mA}$, $V_{CE} = 8\text{ V}$, $f = 500\text{ MHz}$	f_T	3.5	5	-	GHz
Collector-base capacitance $V_{CB} = 10\text{ V}$, $V_{BE} = v_{be} = 0$, $f = 1\text{ MHz}$	C_{cb}	-	1.4	2	pF
Collector-emitter capacitance $V_{CE} = 10\text{ V}$, $V_{BE} = v_{be} = 0$, $f = 1\text{ MHz}$	C_{ce}	-	0.4	-	
Emitter-base capacitance $V_{EB} = 0.5\text{ V}$, $V_{CB} = v_{cb} = 0$, $f = 1\text{ MHz}$	C_{eb}	-	4.7	-	
Noise figure $I_C = 20\text{ mA}$, $V_{CE} = 8\text{ V}$, $Z_S = Z_{\text{Sopt}}$ $f = 900\text{ MHz}$ $f = 1.8\text{ GHz}$	F	-	2.8 4.7	-	dB
Power gain ²⁾ $I_C = 70\text{ mA}$, $V_{CE} = 8\text{ V}$, $Z_S = Z_{\text{Sopt}}$ $Z_L = Z_{\text{Lopt}}$ $f = 900\text{ MHz}$ $f = 1.8\text{ GHz}$	G_{ma}	-	11 6.5	-	
Transducer gain $I_C = 70\text{ mA}$, $V_{CE} = 8\text{ V}$, $Z_S = 50\ \Omega$ $f = 900\text{ MHz}$ $f = 1.8\text{ GHz}$	$ S_{21e} ^2$	-	8 3	-	

2) $G_{\text{ma}} = |S_{21}/S_{12}| (k - (k^2 - 1)^{1/2})$

Total power dissipation $P_{tot} = f(T_A^*, T_S)$

* Package mounted on epoxy

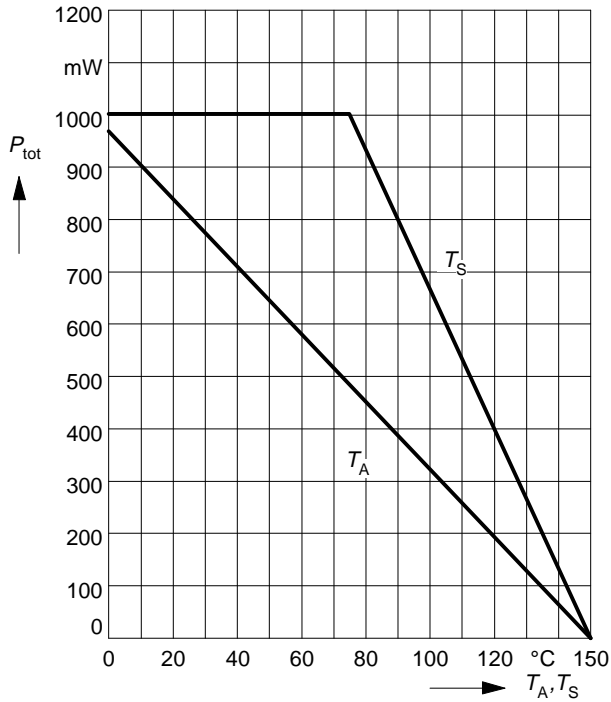

Permissible Pulse Load $R_{thJS} = f(t_p)$

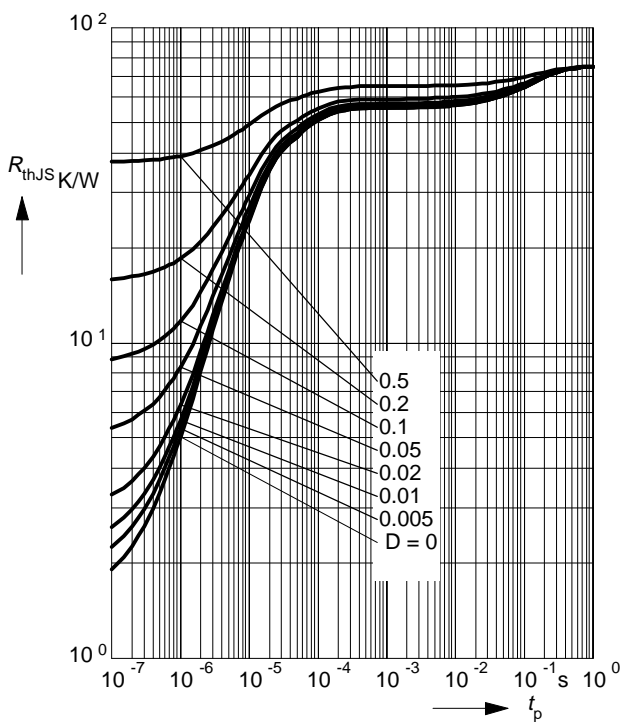

Permissible Pulse Load $P_{totmax}/P_{totDC} = f(t_p)$

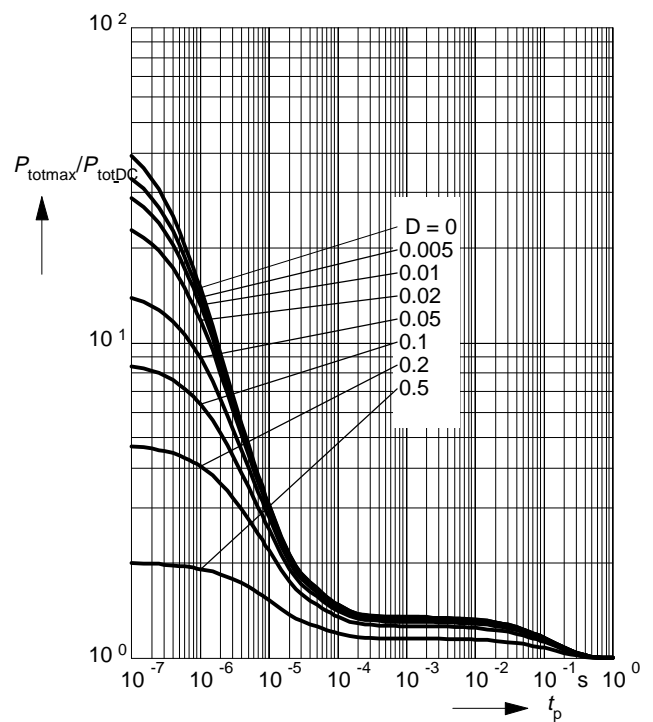

Collector-base capacitance $C_{cb} = f(V_{CB})$

$V_{BE} = v_{be} = 0, f = 1\text{MHz}$

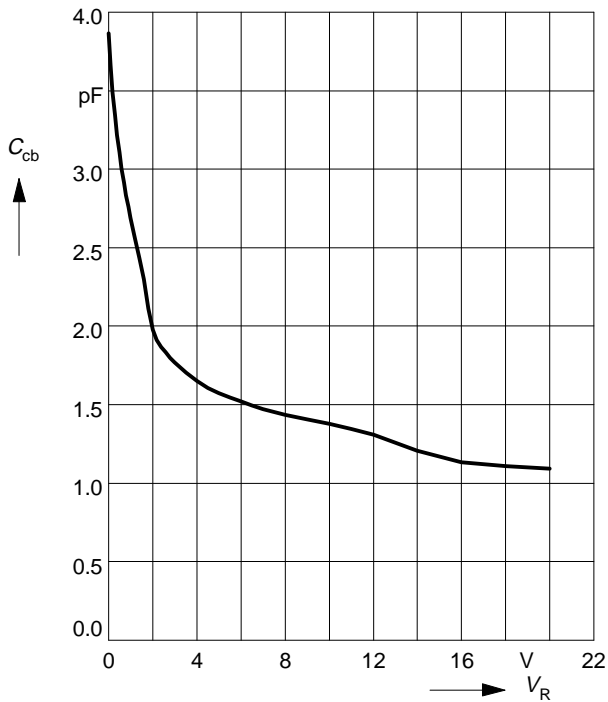

Transition frequency $f_T = f(I_C)$

$V_{CE} = \text{Parameter}$

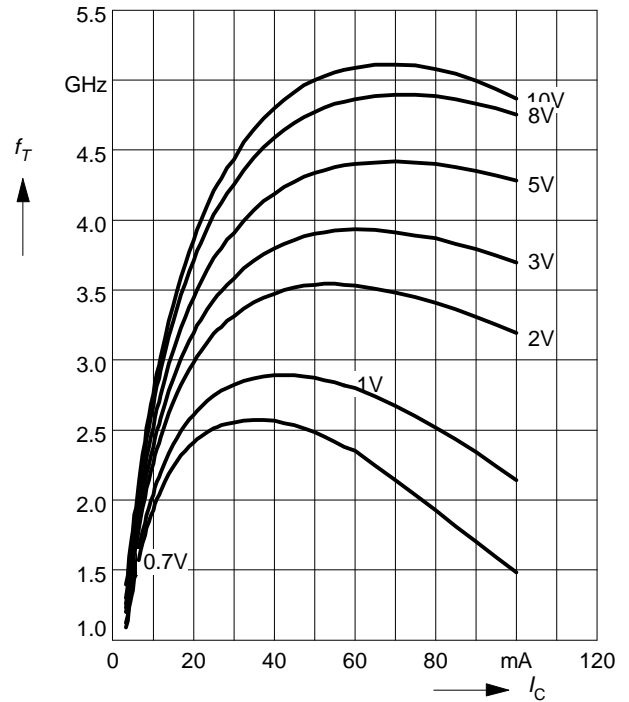

Power Gain $G_{ma}, G_{ms} = f(I_C)$

$f = 0.9\text{GHz}$

$V_{CE} = \text{Parameter}$

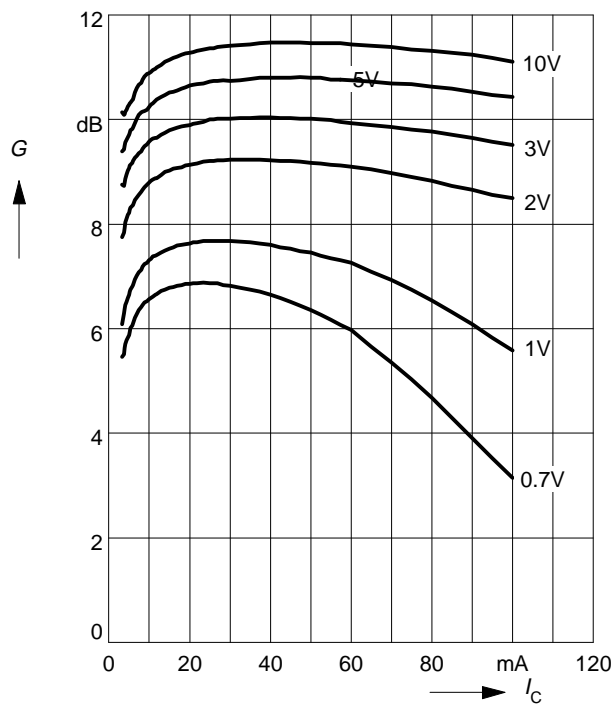

Power Gain $G_{ma}, G_{ms} = f(I_C)$

$f = 1.8\text{GHz}$

$V_{CE} = \text{Parameter}$

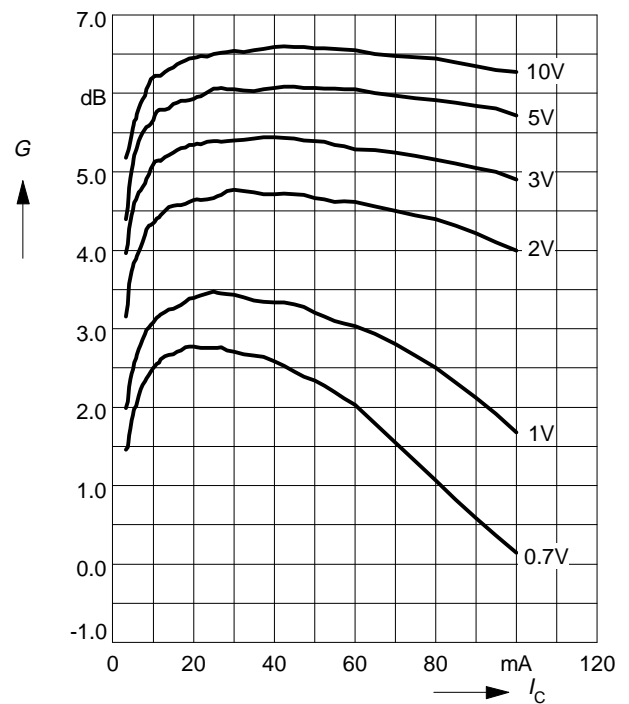

Power Gain $G_{ma}, G_{ms} = f(V_{CE})$: _____
 $|S_{21}|^2 = f(V_{CE})$: - - - - -

f = Parameter

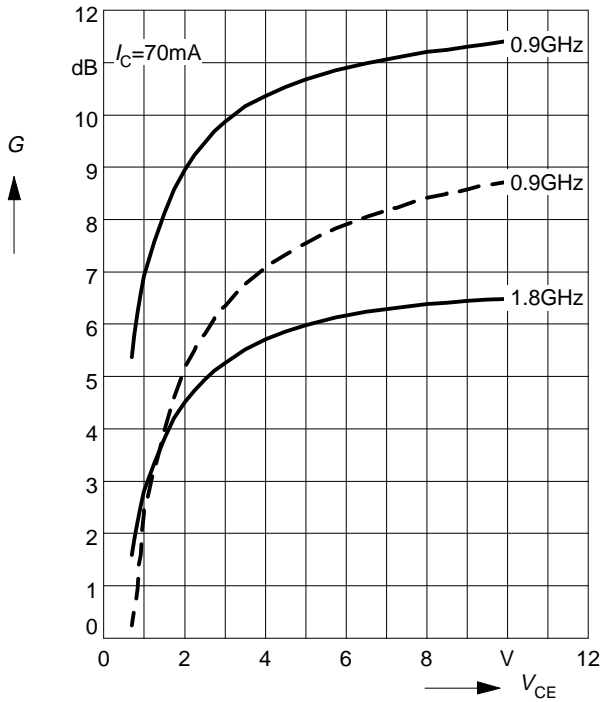

Intermodulation Intercept Point $IP_3 = f(I_C)$
 (3rd order, Output, $Z_S = Z_L = 50\Omega$)

V_{CE} = Parameter, $f = 900MHz$

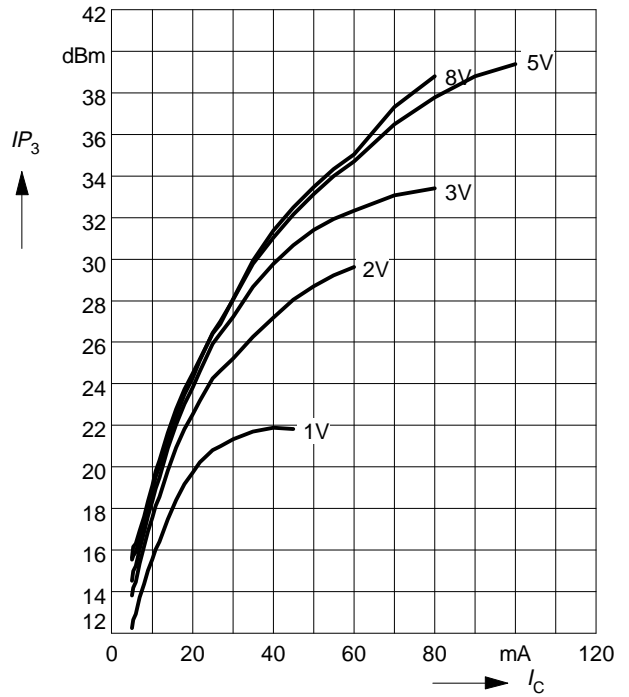

Power Gain $G_{ma}, G_{ms} = f(f)$

V_{CE} = Parameter

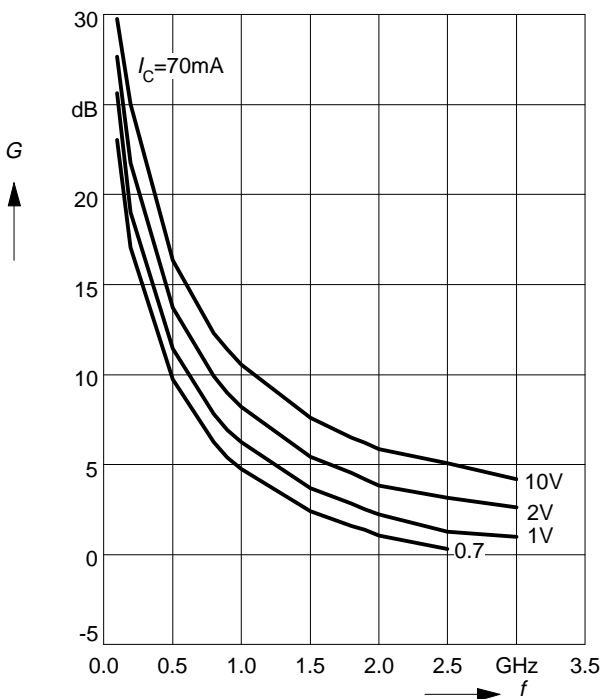

Power Gain $|S_{21}|^2 = f(f)$

V_{CE} = Parameter

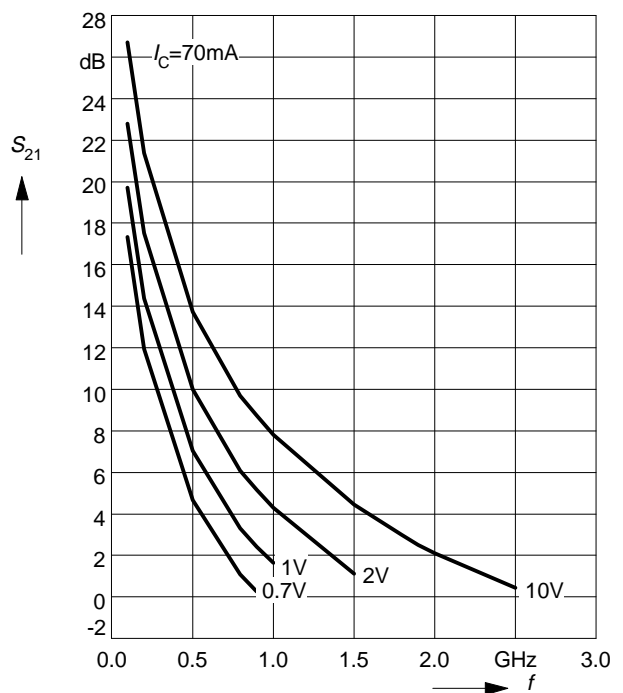

Package

