

DISCRETE SEMICONDUCTORS

DATA SHEET

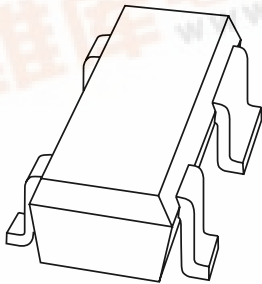

BFG480W

NPN wideband transistor

Product specification
Supersedes data of 1998 Jul 09

1998 Oct 21

NPN wideband transistor**BFG480W****FEATURES**

- High power gain
- High efficiency
- Low noise figure
- High transition frequency
- Emitter is thermal lead
- Low feedback capacitance
- Linear and non-linear operation.

APPLICATIONS

- RF front end with high linearity system demands (CDMA)
- Common emitter class AB driver.

DESCRIPTION

NPN double polysilicon wideband transistor with buried layer for low voltage applications in a 4-pin dual-emitter SOT343R plastic package.

PINNING

PIN	DESCRIPTION
1	emitter
2	base
3	emitter
4	collector

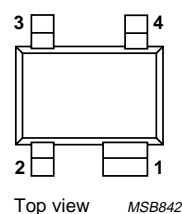

Marking code: P6.

Fig.1 Simplified outline SOT343R.

QUICK REFERENCE DATA

SYMBOL	PARAMETER	CONDITIONS	TYP.	MAX.	UNIT
V_{CE0}	collector-emitter voltage	open base	–	4.5	V
I_C	collector current (DC)		80	250	mA
P_{tot}	total power dissipation	$T_s \leq 60\text{ }^\circ\text{C}$	–	360	mW
f_T	transition frequency	$I_C = 80\text{ mA}$; $V_{CE} = 2\text{ V}$; $f = 2\text{ GHz}$; $T_{amb} = 25\text{ }^\circ\text{C}$	21	–	GHz
G_{max}	maximum gain	$I_C = 80\text{ mA}$; $V_{CE} = 2\text{ V}$; $f = 2\text{ GHz}$; $T_{amb} = 25\text{ }^\circ\text{C}$	16	–	dB
F	noise figure	$I_C = 8\text{ mA}$; $V_{CE} = 2\text{ V}$; $f = 2\text{ GHz}$; $\Gamma_S = \Gamma_{opt}$	1.8	–	dB
G_p	power gain	Pulsed; class-AB; $\delta < 1 : 2$; $t_p = 5\text{ ms}$; $V_{CE} = 3.6\text{ V}$; $f = 2\text{ GHz}$; $P_L = 100\text{ mW}$	13.5	–	dB
η_C	collector efficiency	Pulsed; class-AB; $\delta < 1 : 2$; $t_p = 5\text{ ms}$; $V_{CE} = 3.6\text{ V}$; $f = 2\text{ GHz}$; $P_L = 100\text{ mW}$	45	–	%

CAUTION

This product is supplied in anti-static packing to prevent damage caused by electrostatic discharge during transport and handling. For further information, refer to Philips specs.: SNW-EQ-608, SNW-FQ-302A, and SNW-FQ-302B.

NPN wideband transistor

BFG480W

LIMITING VALUES

In accordance with the Absolute Maximum Rating System (IEC 134).

SYMBOL	PARAMETER	CONDITIONS	MIN.	MAX.	UNIT
V_{CB0}	collector-base voltage	open emitter	–	14.5	V
V_{CEO}	collector-emitter voltage	open base	–	4.5	V
V_{EBO}	emitter-base voltage	open collector	–	1	V
I_C	collector current (DC)		–	250	mA
P_{tot}	total power dissipation	$T_s \leq 60\text{ °C}$; note 1; see Fig.2	–	360	mW
T_{stg}	storage temperature		–65	+150	°C
T_j	operating junction temperature		–	150	°C

Note

- T_s is the temperature at the soldering point of the emitter pins.

THERMAL CHARACTERISTICS

SYMBOL	PARAMETER	VALUE	UNIT
$R_{th\ j-s}$	thermal resistance from junction to soldering point	250	K/W

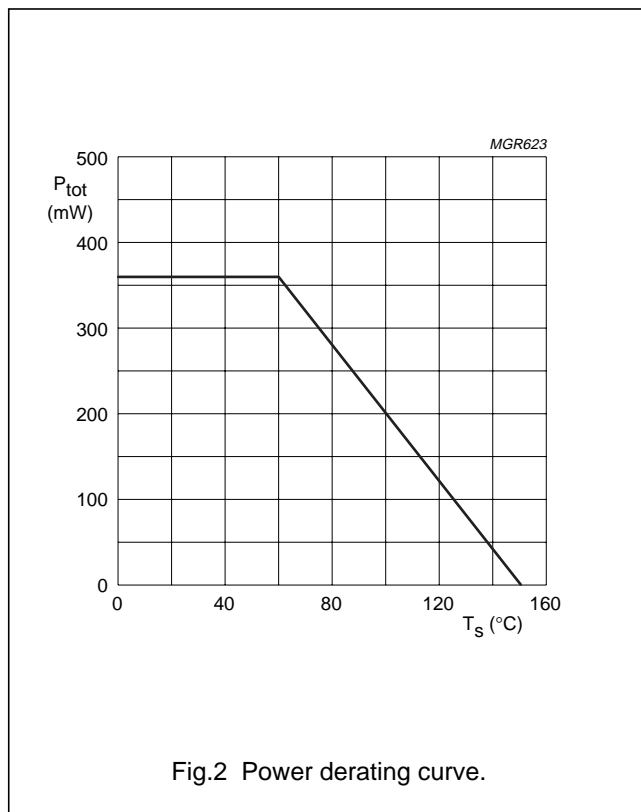

NPN wideband transistor

BFG480W

CHARACTERISTICS

$T_j = 25\text{ °C}$ unless otherwise specified.

SYMBOL	PARAMETER	CONDITIONS	MIN.	TYP.	MAX.	UNIT
$V_{(BR)CBO}$	collector-base breakdown voltage	$I_C = 50\ \mu\text{A}; I_E = 0$	14.5	–	–	V
$V_{(BR)CEO}$	collector-emitter breakdown voltage	$I_C = 5\ \text{mA}; I_B = 0$	4.5	–	–	V
$V_{(BR)EBO}$	emitter-base breakdown voltage	$I_E = 100\ \mu\text{A}; I_C = 0$	1	–	–	V
I_{CBO}	collector-base leakage current	$V_{CE} = 5\ \text{V}; V_{BE} = 0$	–	–	70	nA
h_{FE}	DC current gain	$I_C = 80\ \text{mA}; V_{CE} = 2\ \text{V}$; see Fig.3	40	60	100	
C_c	collector capacitance	$I_E = i_e = 0; V_{CB} = 2\ \text{V}; f = 1\ \text{MHz}$	–	1.4	–	pF
C_e	emitter capacitance	$I_C = i_c = 0; V_{EB} = 0.5\ \text{V}; f = 1\ \text{MHz}$	–	2.2	–	pF
C_{re}	feedback capacitance	$I_C = 0; V_{CB} = 2\ \text{V}; f = 1\ \text{MHz}$; see Fig.4	–	340	–	fF
f_T	transition frequency	$I_C = 80\ \text{mA}; V_{CE} = 2\ \text{V}; f = 2\ \text{GHz}$; $T_{amb} = 25\text{ °C}$; see Fig.5	–	21	–	GHz
G_{max}	maximum power gain; note 1	$I_C = 80\ \text{mA}; V_{CE} = 2\ \text{V}; f = 2\ \text{GHz}$; $T_{amb} = 25\text{ °C}$; see Figs 7 and 8	–	16	–	dB
$ S_{21} ^2$	insertion power gain	$I_C = 80\ \text{mA}; V_{CE} = 2\ \text{V}; f = 2\ \text{GHz}$; $T_{amb} = 25\text{ °C}$; see Fig.8	–	12	–	dB
F	noise figure	$I_C = 8\ \text{mA}; V_{CE} = 2\ \text{V}; f = 900\ \text{MHz}$; $\Gamma_S = \Gamma_{opt}$; see Fig.13	–	1.2	–	dB
		$I_C = 8\ \text{mA}; V_{CE} = 2\ \text{V}; f = 2\ \text{GHz}$; $\Gamma_S = \Gamma_{opt}$; see Fig.13	–	1.8	–	dB
P_{L1}	output power at 1 dB gain compression	Class-AB; $\delta < 1 : 2$; $t_p = 5\ \text{ms}$; $V_{CE} = 3.6\ \text{V}; I_{CQ} = 1\ \text{mA}; f = 2\ \text{GHz}$	–	20	–	dBm
ITO	third order intercept point	$I_C = 80\ \text{mA}; V_{CE} = 2\ \text{V}; f = 2\ \text{GHz}$; $Z_S = Z_{S\ opt}; Z_L = Z_{L\ opt}$; note 2	–	28	–	dBm

Notes

- G_{max} is the maximum power gain, if $K > 1$. If $K < 1$ then $G_{max} = \text{MSG}$; see Figs 6, 7 and 8.
- Z_S is optimized for noise; Z_L is optimized for gain.

NPN wideband transistor

BFG480W

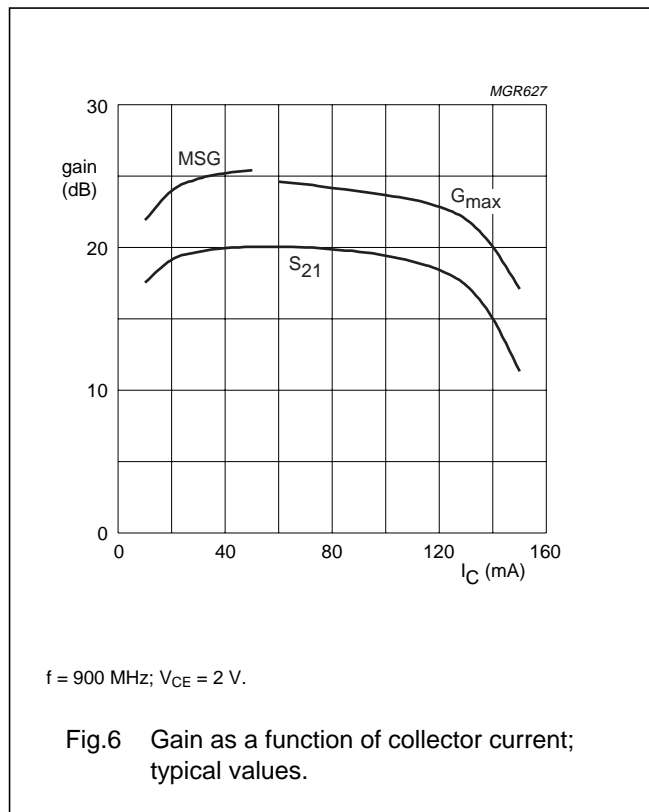
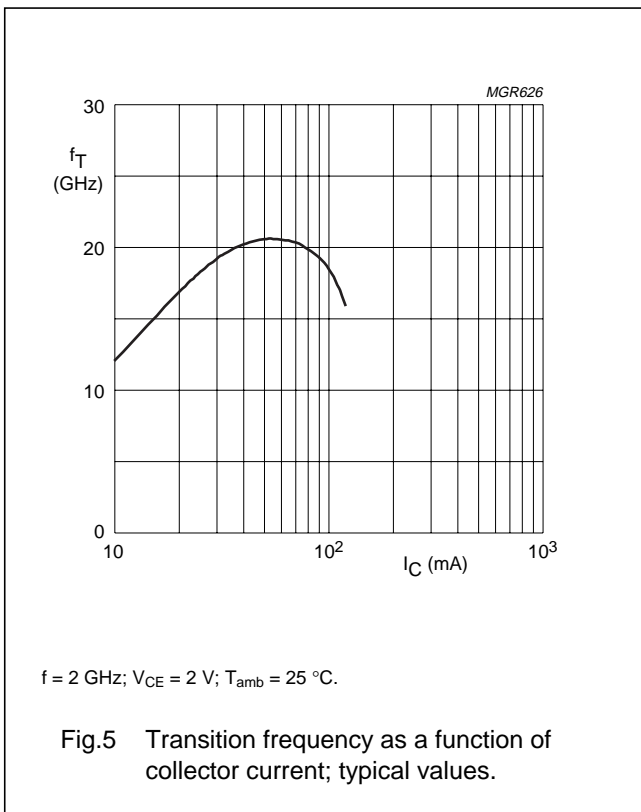
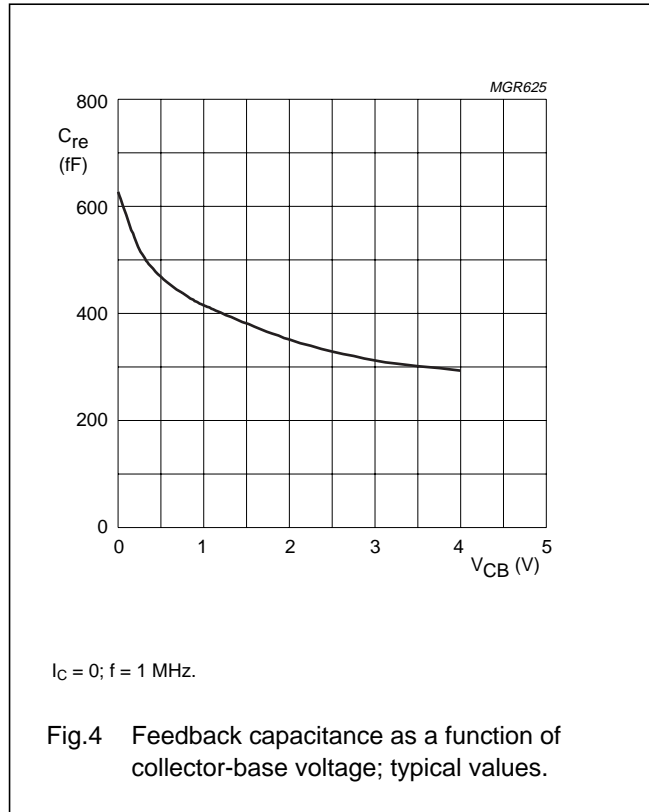
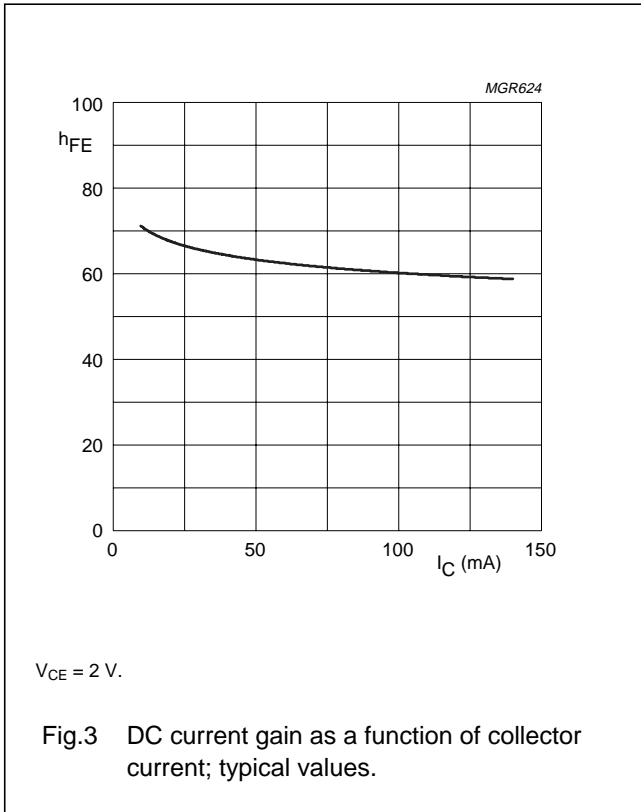

NPN wideband transistor

BFG480W

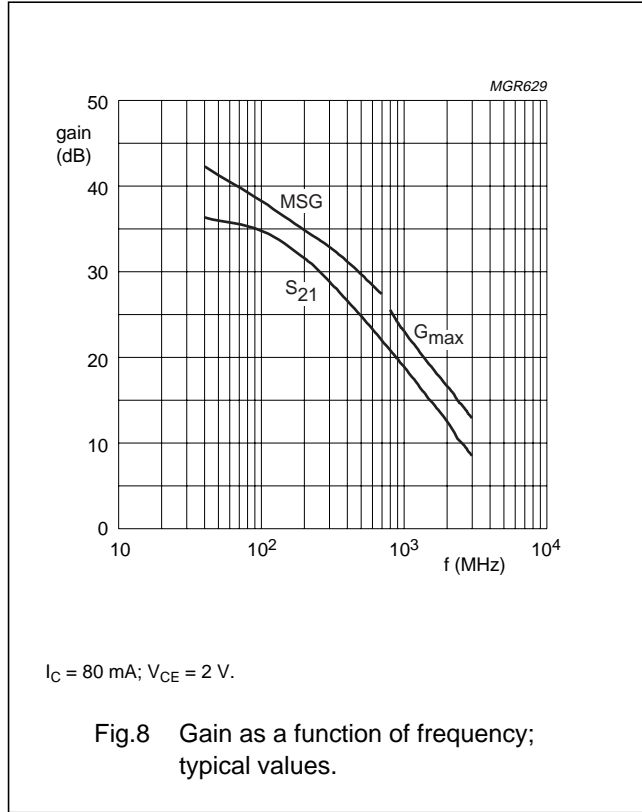
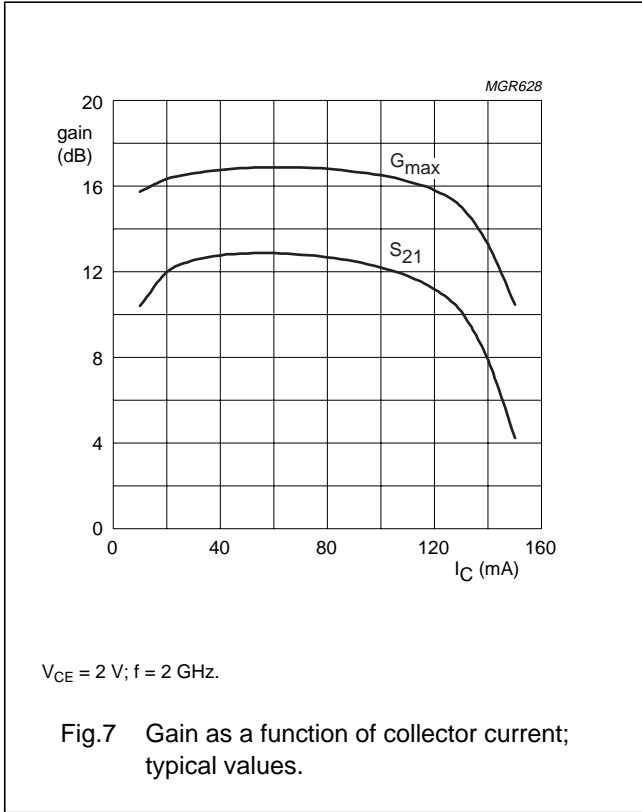

NPN wideband transistor

BFG480W

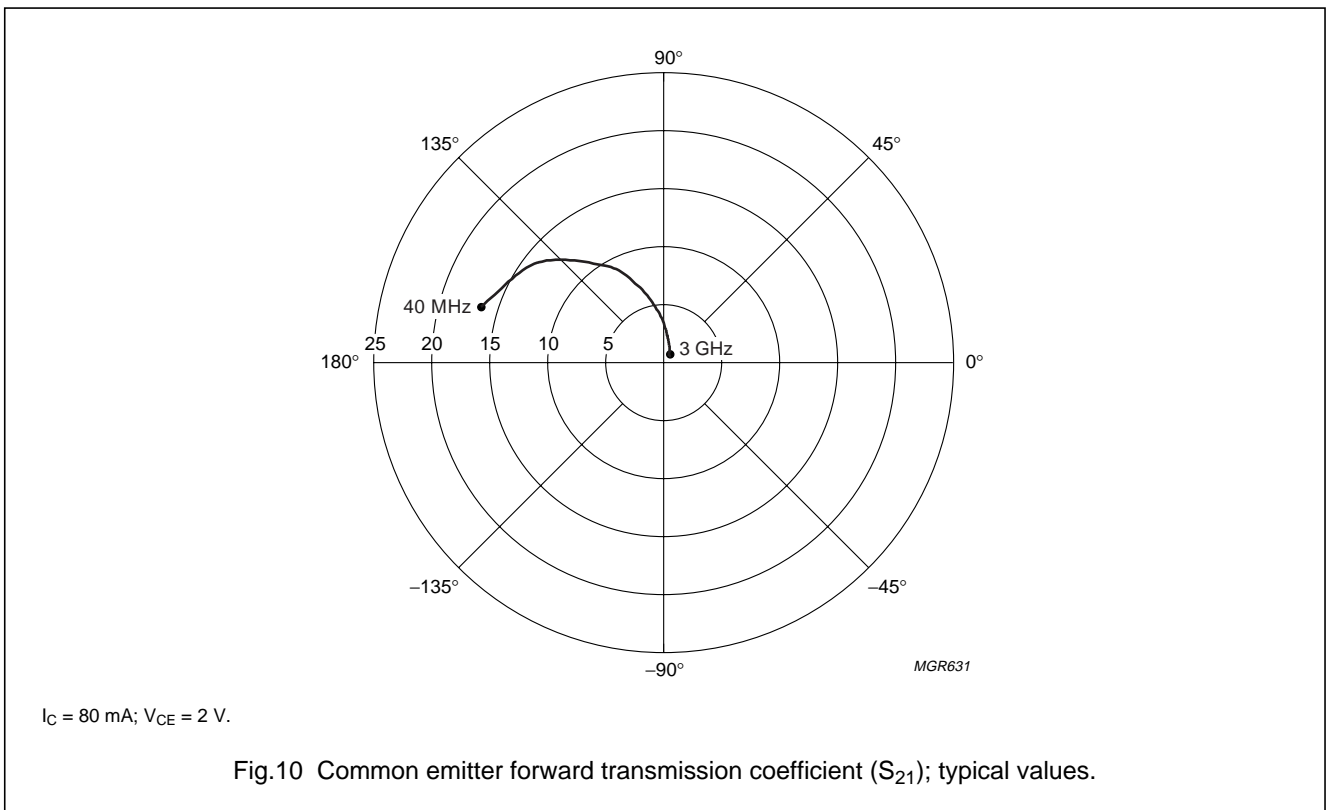
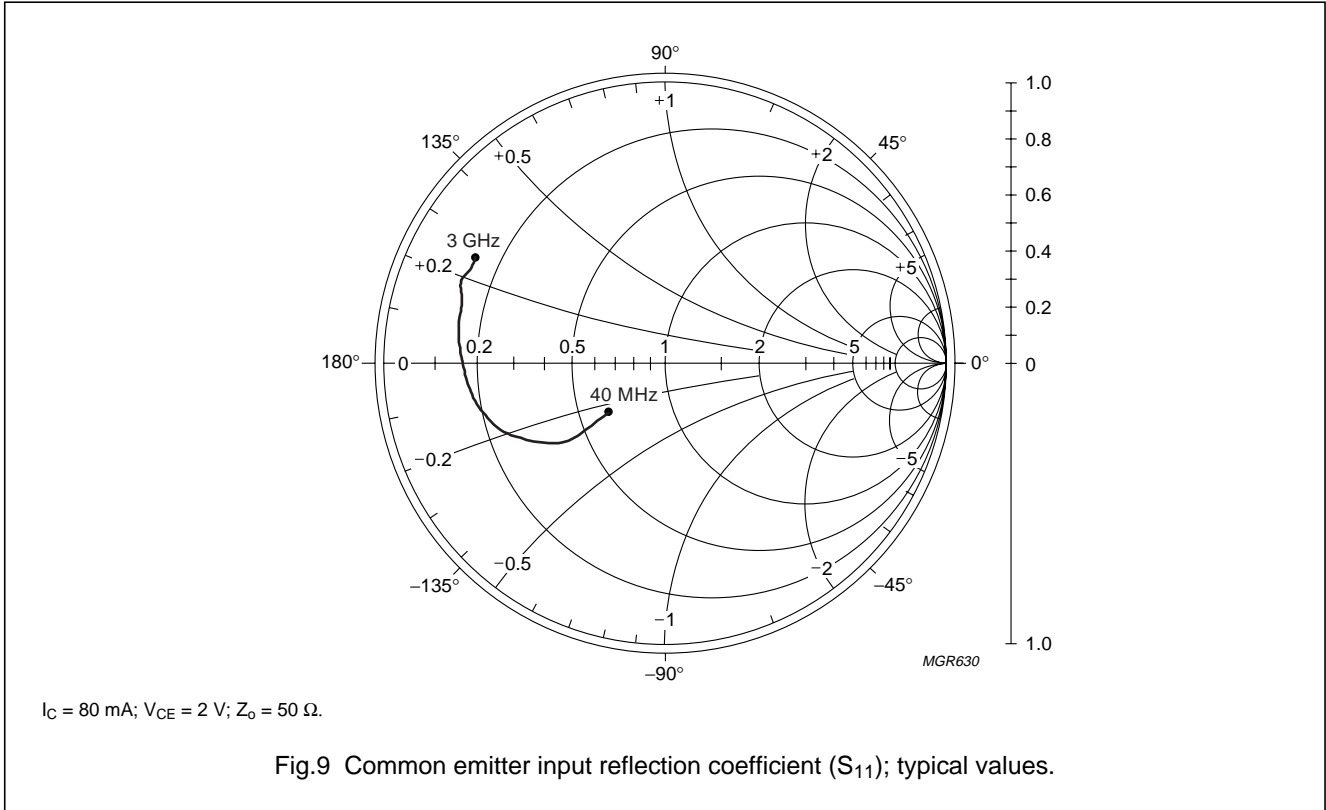

NPN wideband transistor

BFG480W

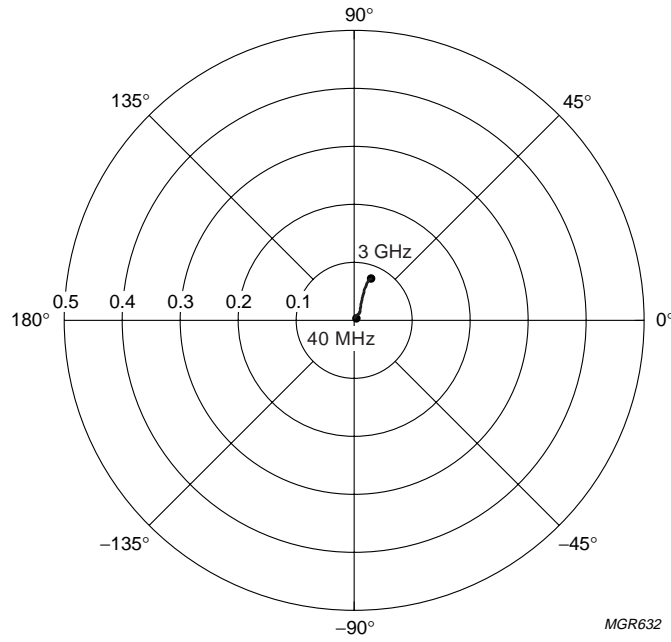

$I_C = 80 \text{ mA}; V_{CE} = 2 \text{ V}.$

MGR632

Fig.11 Common emitter reverse transmission coefficient (S_{12}); typical values.

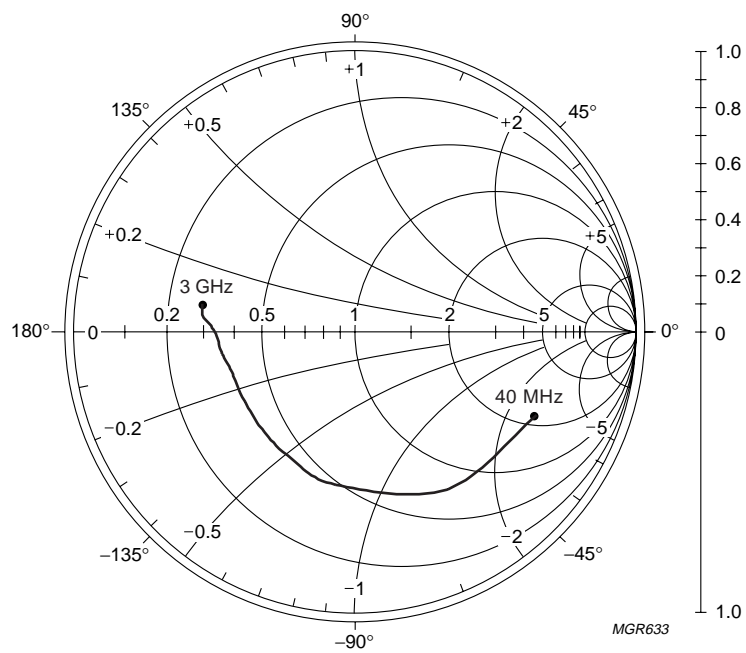

$I_C = 80 \text{ mA}; V_{CE} = 2 \text{ V}; Z_0 = 50 \Omega.$

MGR633

Fig.12 Common emitter output reflection coefficient (S_{22}); typical values.

NPN wideband transistor

BFG480W

Noise data

$V_{CE} = 2\text{ V}$; typical values.

f (MHz)	I _C (mA)	F _{min} (dB)	Γ _{mag}	Γ _{angle}	r _n (Ω)
900	2	1.1	0.41	96.1	0.21
	4	1.1	0.31	106.6	0.14
	6	1.2	0.27	118.4	0.12
	8	1.2	0.26	131.7	0.10
	10	1.3	0.28	143.2	0.10
	20	1.6	0.39	166.2	0.07
	40	2.0	0.49	176.0	0.07
	60	2.3	0.57	179.5	0.07
2000	2	2.4	0.57	171.9	0.09
	4	2.0	0.49	178.9	0.08
	6	1.8	0.46	-175.7	0.09
	8	1.8	0.44	-171.7	0.09
	10	1.8	0.43	-168.4	0.09
	12	1.8	0.44	-165.3	0.10
	14	1.8	0.44	-163.7	0.10
	20	1.9	0.46	-158.3	0.11
	40	2.3	0.52	-150.2	0.14
	60	2.6	0.56	-147.7	0.18
	80	2.8	0.60	-146.1	0.22

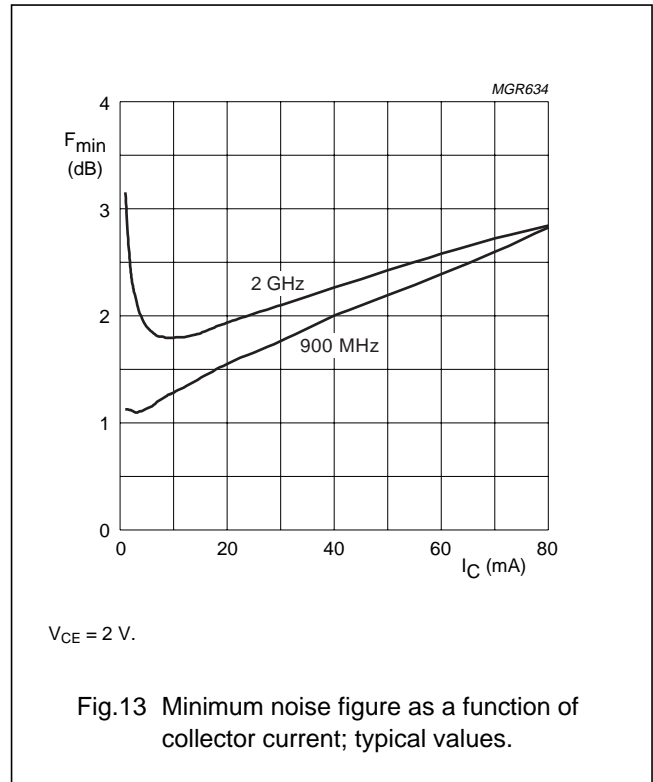

APPLICATION INFORMATION

RF performance at $T_s \leq 60\text{ °C}$ in a common emitter test circuit (see Figs 18 and 19).

MODE OF OPERATION	f (GHz)	V _{CE} (V)	I _{CQ} (mA)	P _L (mW)	G _p (dB)	η _c (%)
Pulsed; class-AB; δ < 1 : 2; t _p = 5 ms	2	3.6	1	100	typ. 13.5	typ. 45

NPN wideband transistor

BFG480W

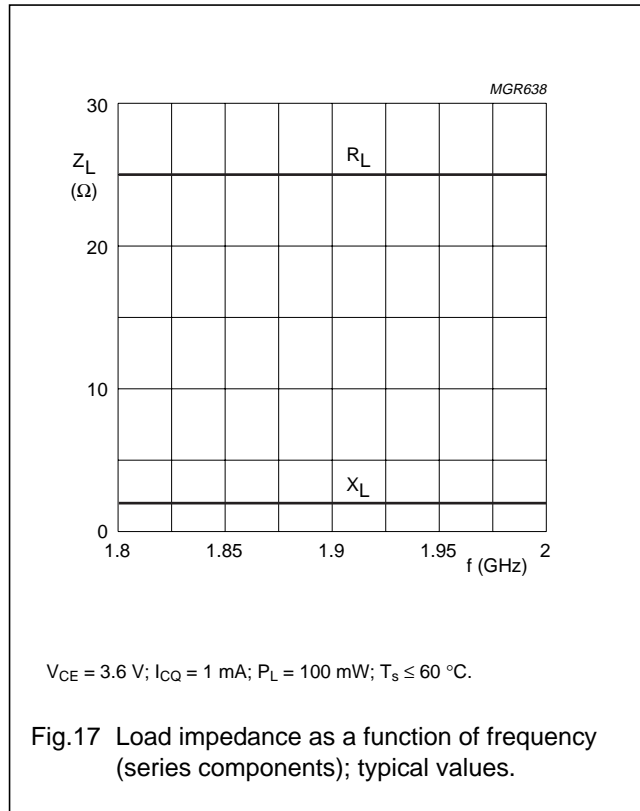
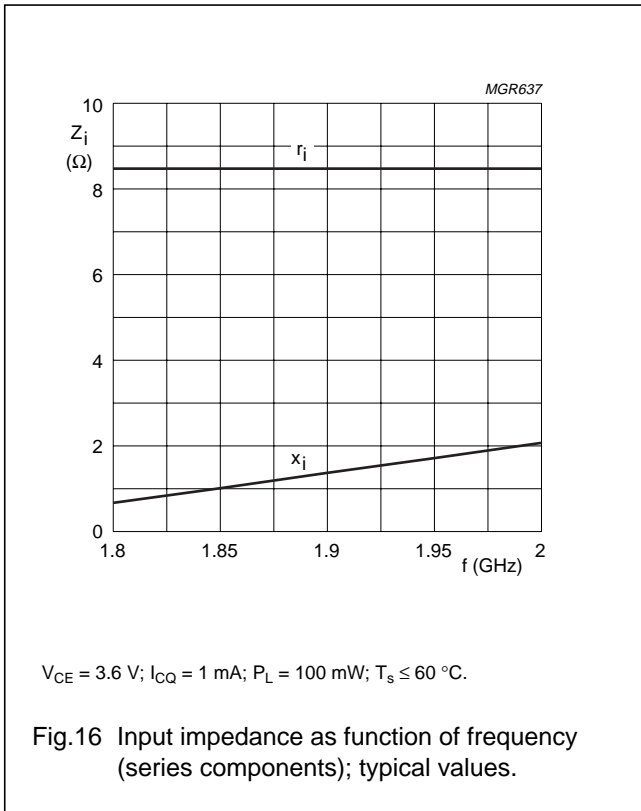
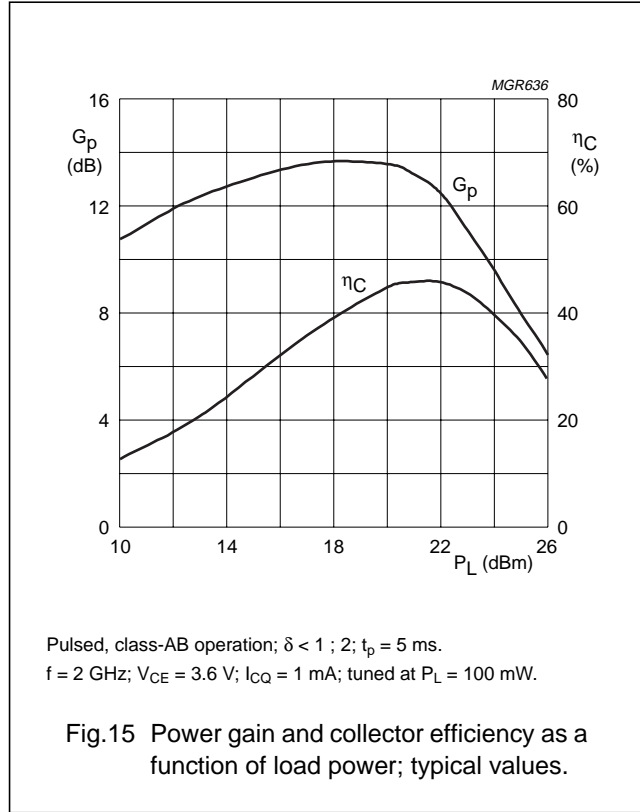
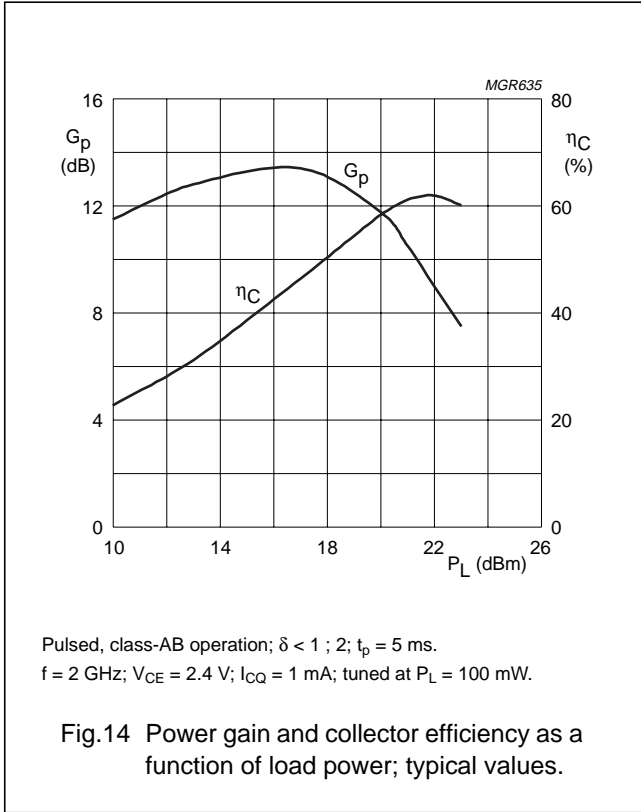

NPN wideband transistor

BFG480W

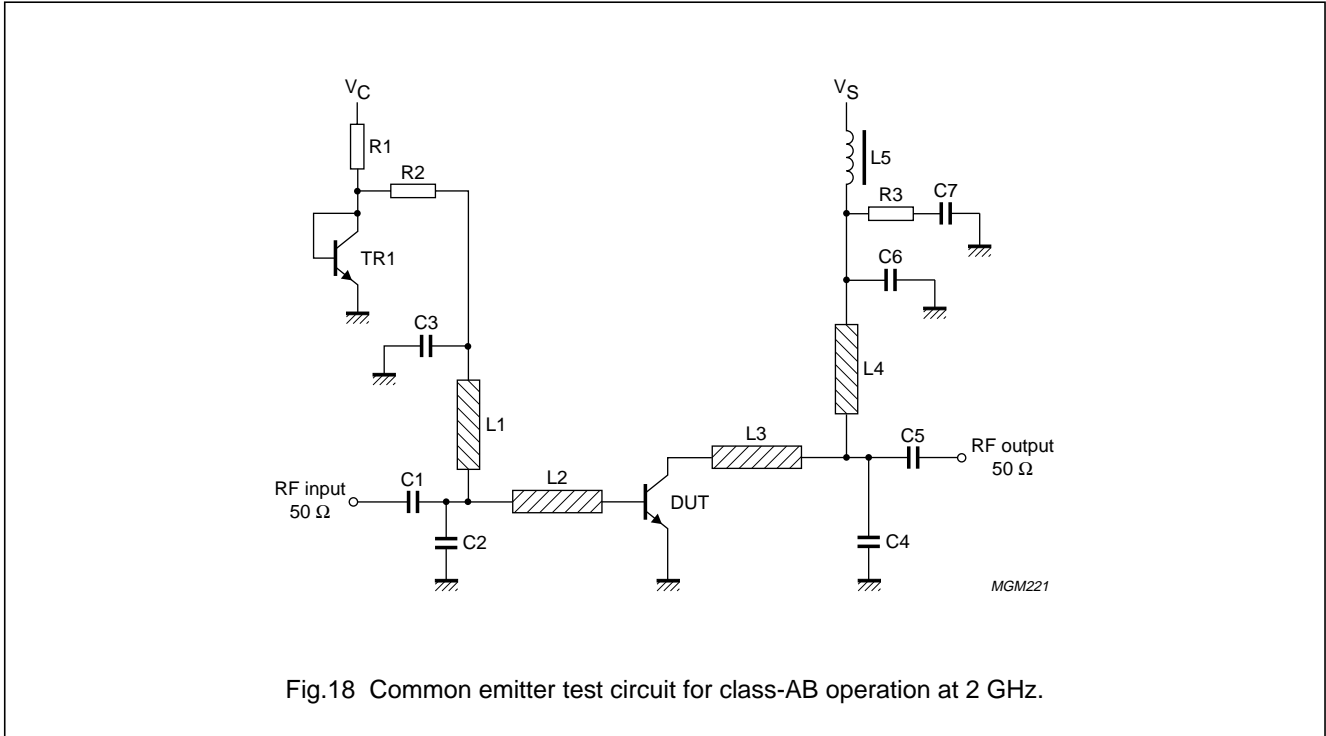

Fig.18 Common emitter test circuit for class-AB operation at 2 GHz.

List of components used in test circuit (see Figs 18 and 19)

COMPONENT	DESCRIPTION	VALUE	DIMENSIONS	CATALOGUE No.
C1, C5	multilayer ceramic chip capacitor; note 1	24 pF		
C2, C4	multilayer ceramic chip capacitor; note 1	2 pF		
C3, C6	multilayer ceramic chip capacitor; note 1	15 pF		
C7	multilayer ceramic chip capacitor; note 1	1 nF		
L1, L4	stripline; note 2	100 Ω	18 x 0.2 mm	
L2	stripline; note 2	50 Ω	5 x 0.8 mm	
L3	stripline; note 2	50 Ω	6 x 0.8 mm	
L5	Grade 4S2 Ferroxcube chip bead			4330 030 36300
R1	metal film resistor	220 Ω; 0.4 W		
R2, R3	metal film resistor	10 Ω; 0.4 W		
TR1	NPN transistor	BC817		9335 895 20215

Notes

- American Technical Ceramics type 100A or capacitor of same quality.
- The striplines are on a double copper-clad printed-circuit board with PTFE fibre-glass dielectric ($\epsilon_r = 6.15$, $\tan \delta = 0.0019$); thickness 0.64 mm, copper cladding = 35 μm .

NPN wideband transistor

BFG480W

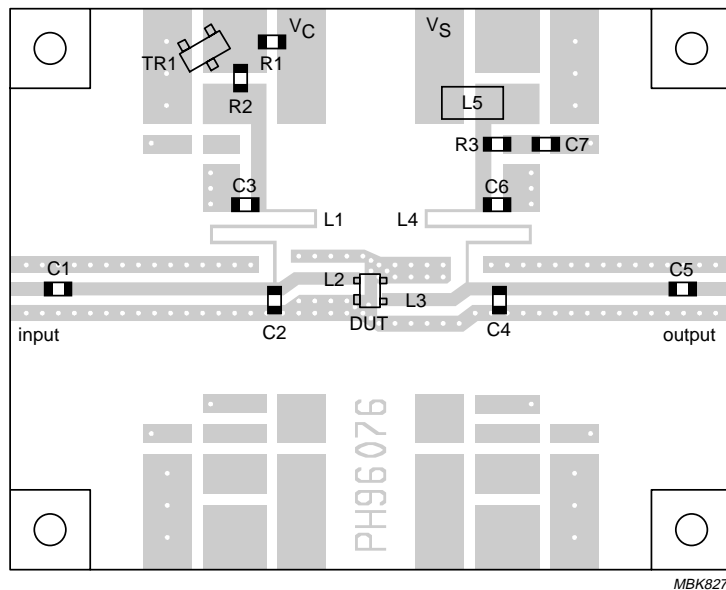
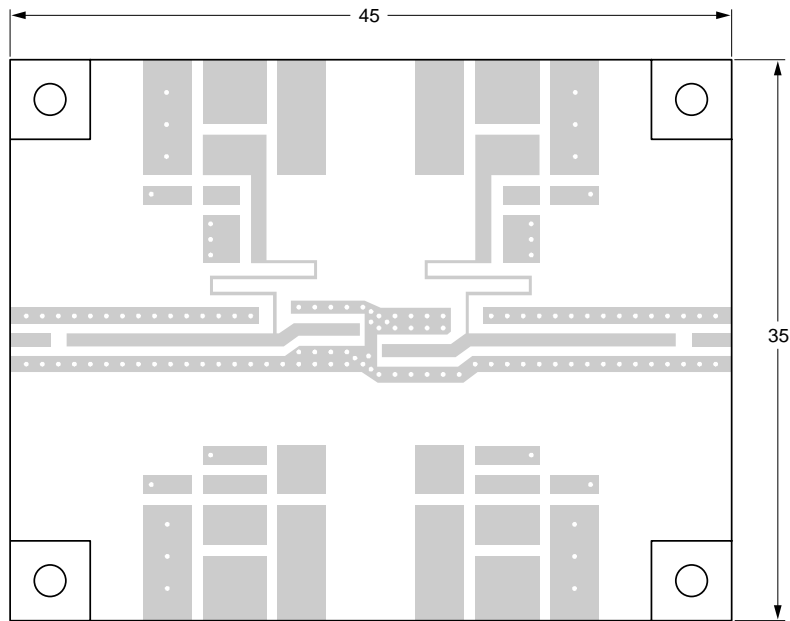

Dimensions in mm.

The components are situated on one side of the copper-clad PTFE fibre-glass board, the other side is unetched and serves as a ground plane. Earth connections from the component side to the ground plane are made by through metallization.

Fig.19 Printed-circuit board and component layout for 2 GHz class-AB test circuit in Fig.18.

NPN wideband transistor

BFG480W

PACKAGE OUTLINE

Plastic surface mounted package; reverse pinning; 4 leads

SOT343R

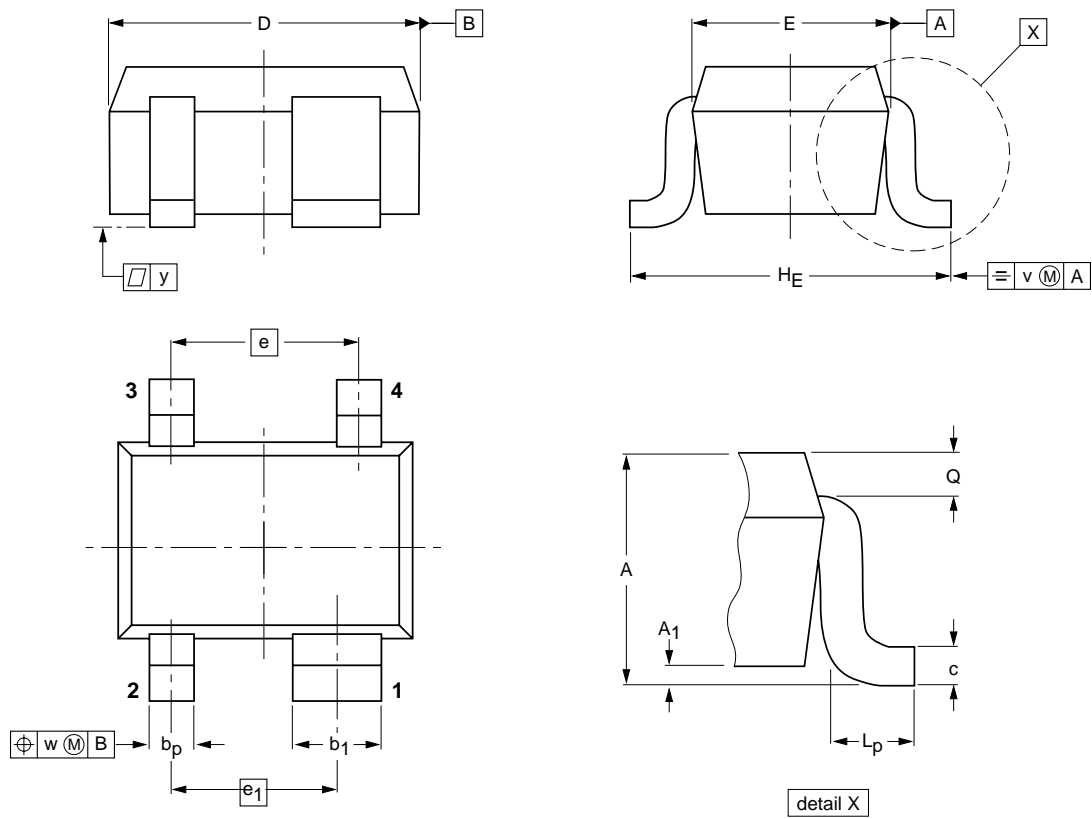

DIMENSIONS (mm are the original dimensions)

UNIT	A	A ₁ max	b _p	b ₁	c	D	E	e	e ₁	H _E	L _p	Q	v	w	y
mm	1.1 0.8	0.1	0.4 0.3	0.7 0.5	0.25 0.10	2.2 1.8	1.35 1.15	1.3	1.15	2.2 2.0	0.45 0.15	0.23 0.13	0.2	0.2	0.1

OUTLINE VERSION	REFERENCES			EUROPEAN PROJECTION	ISSUE DATE
	IEC	JEDEC	EIAJ		
SOT343R					97-05-21

NPN wideband transistor

BFG480W

DEFINITIONS

Data Sheet Status	
Objective specification	This data sheet contains target or goal specifications for product development.
Preliminary specification	This data sheet contains preliminary data; supplementary data may be published later.
Product specification	This data sheet contains final product specifications.
Limiting values	
Limiting values given are in accordance with the Absolute Maximum Rating System (IEC 134). Stress above one or more of the limiting values may cause permanent damage to the device. These are stress ratings only and operation of the device at these or at any other conditions above those given in the Characteristics sections of the specification is not implied. Exposure to limiting values for extended periods may affect device reliability.	
Application information	
Where application information is given, it is advisory and does not form part of the specification.	

LIFE SUPPORT APPLICATIONS

These products are not designed for use in life support appliances, devices, or systems where malfunction of these products can reasonably be expected to result in personal injury. Philips customers using or selling these products for use in such applications do so at their own risk and agree to fully indemnify Philips for any damages resulting from such improper use or sale.

NPN wideband transistor

BFG480W

NOTES

Philips Semiconductors – a worldwide company

Argentina: see South America

Australia: 34 Waterloo Road, NORTH RYDE, NSW 2113,
Tel. +61 2 9805 4455, Fax. +61 2 9805 4466

Austria: Computerstr. 6, A-1101 WIEN, P.O. Box 213, Tel. +43 160 1010,
Fax. +43 160 101 1210

Belarus: Hotel Minsk Business Center, Bld. 3, r. 1211, Volodarski Str. 6,
220050 MINSK, Tel. +375 172 200 733, Fax. +375 172 200 773

Belgium: see The Netherlands

Brazil: see South America

Bulgaria: Philips Bulgaria Ltd., Energoproject, 15th floor,
51 James Bourchier Blvd., 1407 SOFIA,
Tel. +359 2 689 211, Fax. +359 2 689 102

Canada: PHILIPS SEMICONDUCTORS/COMPONENTS,
Tel. +1 800 234 7381

China/Hong Kong: 501 Hong Kong Industrial Technology Centre,
72 Tat Chee Avenue, Kowloon Tong, HONG KONG,
Tel. +852 2319 7888, Fax. +852 2319 7700

Colombia: see South America

Czech Republic: see Austria

Denmark: Prags Boulevard 80, PB 1919, DK-2300 COPENHAGEN S,
Tel. +45 32 88 2636, Fax. +45 31 57 0044

Finland: Sinikalliontie 3, FIN-02630 ESPOO,
Tel. +358 9 615800, Fax. +358 9 61580920

France: 51 Rue Carnot, BP317, 92156 SURESNES Cedex,
Tel. +33 1 40 99 6161, Fax. +33 1 40 99 6427

Germany: Hammerbrookstraße 69, D-20097 HAMBURG,
Tel. +49 40 23 53 60, Fax. +49 40 23 536 300

Greece: No. 15, 25th March Street, GR 17778 TAVROS/ATHENS,
Tel. +30 1 4894 339/239, Fax. +30 1 4814 240

Hungary: see Austria

India: Philips INDIA Ltd, Band Box Building, 2nd floor,
254-D, Dr. Annie Besant Road, Worli, MUMBAI 400 025,
Tel. +91 22 493 8541, Fax. +91 22 493 0966

Indonesia: PT Philips Development Corporation, Semiconductors Division,
Gedung Philips, Jl. Buncit Raya Kav.99-100, JAKARTA 12510,
Tel. +62 21 794 0040 ext. 2501, Fax. +62 21 794 0080

Ireland: Newstead, Clonskeagh, DUBLIN 14,
Tel. +353 1 7640 000, Fax. +353 1 7640 200

Israel: RAPAC Electronics, 7 Kehilat Saloniki St, PO Box 18053,
TEL AVIV 61180, Tel. +972 3 645 0444, Fax. +972 3 649 1007

Italy: PHILIPS SEMICONDUCTORS, Piazza IV Novembre 3,
20124 MILANO, Tel. +39 2 6752 2531, Fax. +39 2 6752 2557

Japan: Philips Bldg 13-37, Kohnan 2-chome, Minato-ku,
TOKYO 108-8507, Tel. +81 3 3740 5130, Fax. +81 3 3740 5077

Korea: Philips House, 260-199 Itaewon-dong, Yongsan-ku, SEOUL,
Tel. +82 2 709 1412, Fax. +82 2 709 1415

Malaysia: No. 76 Jalan Universiti, 46200 PETALING JAYA, SELANGOR,
Tel. +60 3 750 5214, Fax. +60 3 757 4880

Mexico: 5900 Gateway East, Suite 200, EL PASO, TEXAS 79905,
Tel. +9-5 800 234 7381

Middle East: see Italy

Netherlands: Postbus 90050, 5600 PB EINDHOVEN, Bldg. VB,
Tel. +31 40 27 82785, Fax. +31 40 27 88399

New Zealand: 2 Wagener Place, C.P.O. Box 1041, AUCKLAND,
Tel. +64 9 849 4160, Fax. +64 9 849 7811

Norway: Box 1, Manglerud 0612, OSLO,
Tel. +47 22 74 8000, Fax. +47 22 74 8341

Pakistan: see Singapore

Philippines: Philips Semiconductors Philippines Inc.,
106 Valero St. Salcedo Village, P.O. Box 2108 MCC, MAKATI,
Metro MANILA, Tel. +63 2 816 6380, Fax. +63 2 817 3474

Poland: Ul. Lukiska 10, PL 04-123 WARSZAWA,
Tel. +48 22 612 2831, Fax. +48 22 612 2327

Portugal: see Spain

Romania: see Italy

Russia: Philips Russia, Ul. Usatcheva 35A, 119048 MOSCOW,
Tel. +7 095 755 6918, Fax. +7 095 755 6919

Singapore: Lorong 1, Toa Payoh, SINGAPORE 319762,
Tel. +65 350 2538, Fax. +65 251 6500

Slovakia: see Austria

Slovenia: see Italy

South Africa: S.A. PHILIPS Pty Ltd., 195-215 Main Road Martindale,
2092 JOHANNESBURG, P.O. Box 7430 Johannesburg 2000,
Tel. +27 11 470 5911, Fax. +27 11 470 5494

South America: Al. Vicente Pinzon, 173, 6th floor,
04547-130 SÃO PAULO, SP, Brazil,
Tel. +55 11 821 2333, Fax. +55 11 821 2382

Spain: Balmes 22, 08007 BARCELONA,
Tel. +34 93 301 6312, Fax. +34 93 301 4107

Sweden: Kottbygatan 7, Akalla, S-16485 STOCKHOLM,
Tel. +46 8 5985 2000, Fax. +46 8 5985 2745

Switzerland: Allmendstrasse 140, CH-8027 ZÜRICH,
Tel. +41 1 488 2741 Fax. +41 1 488 3263

Taiwan: Philips Semiconductors, 6F, No. 96, Chien Kuo N. Rd., Sec. 1,
TAIPEI, Taiwan Tel. +886 2 2134 2865, Fax. +886 2 2134 2874

Thailand: PHILIPS ELECTRONICS (THAILAND) Ltd.,
209/2 Sanpavuth-Bangna Road Prakanong, BANGKOK 10260,
Tel. +66 2 745 4090, Fax. +66 2 398 0793

Turkey: Talatpasa Cad. No. 5, 80640 GÜLTEPE/ISTANBUL,
Tel. +90 212 279 2770, Fax. +90 212 282 6707

Ukraine: PHILIPS UKRAINE, 4 Patrice Lumumba str., Building B, Floor 7,
252042 KIEV, Tel. +380 44 264 2776, Fax. +380 44 268 0461

United Kingdom: Philips Semiconductors Ltd., 276 Bath Road, Hayes,
MIDDLESEX UB3 5BX, Tel. +44 181 730 5000, Fax. +44 181 754 8421

United States: 811 East Arques Avenue, SUNNYVALE, CA 94088-3409,
Tel. +1 800 234 7381

Uruguay: see South America

Vietnam: see Singapore

Yugoslavia: PHILIPS, Trg N. Pasica 5/v, 11000 BEOGRAD,
Tel. +381 11 625 344, Fax. +381 11 635 777

For all other countries apply to: Philips Semiconductors,
International Marketing & Sales Communications, Building BE-p, P.O. Box 218,
5600 MD EINDHOVEN, The Netherlands, Fax. +31 40 27 24825

Internet: <http://www.semiconductors.philips.com>

© Philips Electronics N.V. 1998

SCA60

All rights are reserved. Reproduction in whole or in part is prohibited without the prior written consent of the copyright owner.

The information presented in this document does not form part of any quotation or contract, is believed to be accurate and reliable and may be changed without notice. No liability will be accepted by the publisher for any consequence of its use. Publication thereof does not convey nor imply any license under patent- or other industrial or intellectual property rights.

Printed in The Netherlands

125104/00/03/pp16

Date of release: 1998 Oct 21

Document order number: 9397 750 04587

Let's make things better.

Philips



PHILIPS