



BFR340F

NPN Silicon RF Transistor

Preliminary data

- Low voltage/ low current operation
- Transition frequency of 14 GHz
- High insertion gain
- Ideal for low current amplifiers and oscillators

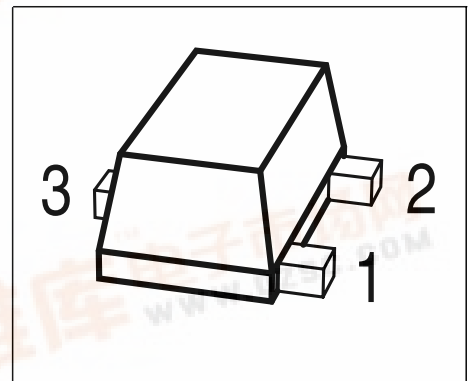

ESD: Electrostatic discharge sensitive device, observe handling precaution!

Type	Marking	Pin Configuration			Package
BFR340F	FAs	1 = B	2 = E	3 = C	TSFP-3

Maximum Ratings

Parameter	Symbol	Value	Unit
Collector-emitter voltage	V_{CEO}	6	V
Collector-emitter voltage	V_{CES}	15	
Collector-base voltage	V_{CBO}	15	
Emitter-base voltage	V_{EBO}	2	
Collector current	I_C	10	mA
Base current	I_B	2	
Total power dissipation ¹⁾ $T_S \leq 118^\circ\text{C}$	P_{tot}	60	mW
Junction temperature	T_j	150	°C
Ambient temperature	T_A	-65 ... 150	
Storage temperature	T_{stg}	-65 ... 150	

Thermal Resistance

Parameter	Symbol	Value	Unit
Junction - soldering point ²⁾	R_{thJS}	≤ 530	K/W

¹⁾ T_S is measured on the collector lead at the soldering point to the pcb

²⁾ For calculation of R_{thJA} please refer to Application Note Thermal Resistance



Electrical Characteristics at $T_A = 25^\circ\text{C}$, unless otherwise specified

Parameter	Symbol	Values			Unit
		min.	typ.	max.	
Characteristics					
Collector-emitter breakdown voltage $I_C = 1 \text{ mA}, I_B = 0$	$V_{(BR)CEO}$	6	9	-	V
Collector-emitter cutoff current $V_{CE} = 15 \text{ V}, V_{BE} = 0$	I_{CES}	-	-	10	μA
Collector-base cutoff current $V_{CB} = 5 \text{ V}, I_E = 0$	I_{CBO}	-	-	100	nA
Emitter-base cutoff current $V_{EB} = 1 \text{ V}, I_C = 0$	I_{EBO}	-	-	1	μA
DC current gain- $I_C = 5 \text{ mA}, V_{CE} = 3 \text{ V}$	h_{FE}	60	130	200	-

Electrical Characteristics at $T_A = 25^\circ\text{C}$, unless otherwise specified

Parameter	Symbol	Values			Unit
		min.	typ.	max.	
AC Characteristics (verified by random sampling)					
Transition frequency $I_C = 6\text{ mA}$, $V_{CE} = 3\text{ V}$, $f = 1\text{ GHz}$	f_T	11	14	-	GHz
Collector-base capacitance $V_{CB} = 5\text{ V}$, $f = 1\text{ MHz}$, emitter grounded	C_{cb}	-	0.21	0.4	pF
Collector emitter capacitance $V_{CE} = 5\text{ V}$, $f = 1\text{ MHz}$, base grounded	C_{ce}	-	0.17	-	
Emitter-base capacitance $V_{EB} = 0.5\text{ V}$, $f = 1\text{ MHz}$, collector grounded	C_{eb}	-	0.11	-	
Noise figure $I_C = 1\text{ mA}$, $V_{CE} = 3\text{ V}$, $Z_S = Z_{Sopt}$, $f = 1.8\text{ GHz}$	F_{min}	-	1.15	-	dB
Power gain, maximum stable ¹⁾ $I_C = 5\text{ mA}$, $V_{CE} = 3\text{ V}$, $Z_S = Z_{Sopt}$, $Z_L = Z_{Lopt}$, $f = 1.8\text{ GHz}$	G_{ms}	-	16	-	-
Power gain, maximum available ¹⁾ $I_C = 5\text{ mA}$, $V_{CE} = 3\text{ V}$, $Z_S = Z_{Sopt}$, $Z_L = Z_{Lopt}$, $f = 3\text{ GHz}$	G_{ma}	-	12	-	dB
Transducer gain $I_C = 5\text{ mA}$, $V_{CE} = 3\text{ V}$, $Z_S = Z_L = 50\Omega$, $f = 1.8\text{ GHz}$ $I_C = 5\text{ mA}$, $V_{CE} = 3\text{ V}$, $Z_S = Z_L = 50\Omega$, $f = 3\text{ GHz}$	$ S_{21e} ^2$	-	13	-	dB
		-	9.5	-	
Third order intercept point at output ²⁾ $V_{CE} = 3\text{ V}$, $I_C = 5\text{ mA}$, $f = 1.8\text{ GHz}$, $Z_S = Z_L = 50\Omega$	IP_3	-	13	-	dBm
1dB Compression point at output $I_C = 5\text{ mA}$, $V_{CE} = 3\text{ V}$, $Z_S = Z_L = 50\Omega$, $f = 1.8\text{ GHz}$	P_{-1dB}	-	0	-	

$$^1G_{ma} = |S_{21e} / S_{12e}| (k - (k^2 - 1)^{1/2}), G_{ms} = |S_{21e} / S_{12e}|$$

²⁾IP3 value depends on termination of all intermodulation frequency components.
Termination used for this measurement is 50Ω from 0.1 MHz to 6 GHz

SPICE Parameter (Gummel-Poon Model, Berkley-SPICE 2G.6 Syntax):

Transistor Chip Data:

IS =	6.12	fA	BF =	98.48	-	NF =	0.4213	-
VAF =	42.228	V	IKF =	103	mA	ISE =	11.768	nA
NE =	2.4753	-	BR =	19.61	-	NR =	0.3253	-
VAR =	16.777	V	IKR =	0.834	A	ISC =	3.632	nA
NC =	0.8956	-	RB =	59.99	Ω	IRB =	0.01	mA
RBM =	0.2403	Ω	RE =	3.677	-	RC =	5.2493	Ω
CJE =	182	fF	VJE =	0.626	V	MJE =	0.4172	-
TF =	10.3	ps	XTF =	0	-	VTF =	0.262	V
ITF =	0.0017	mA	PTF =	0	deg	CJC =	222.63	fF
VJC =	0.5487	V	MJC =	0.319	-	XCJC =	0.3904	-
TR =	2.71	ns	CJS =	0	fF	VJS =	0.75	V
MJS =	0	-	NK =	0.5	-	EG =	1.11	eV
XTI =	0	-	FC =	0.735	-	TNOM =	300	K

All parameters are ready to use, no scaling is necessary. Extracted on behalf of Infineon Technologies AG by: Institut für Mobil- und Satellitentechnik (IMST)

Package Equivalent Circuit:

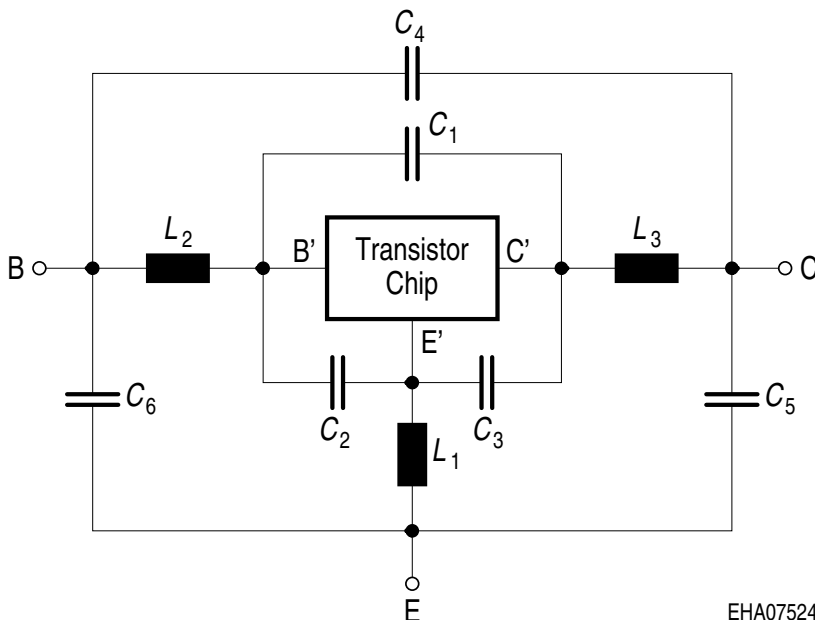

$L_1 =$	0.556	nH
$L_2 =$	0.657	nH
$L_3 =$	0.381	nH
$C_1 =$	43	fF
$C_2 =$	123	fF
$C_3 =$	66	fF
$C_4 =$	10	fF
$C_5 =$	36	fF
$C_6 =$	47	fF

Valid up to 6GHz

EHA07524

For examples and ready to use parameters please contact your local Infineon Technologies distributor or sales office to obtain a Infineon Technologies CD-ROM or see Internet: <http://www.infineon.com/silicondiscretres>

Total power dissipation $P_{tot} = f(T_S)$

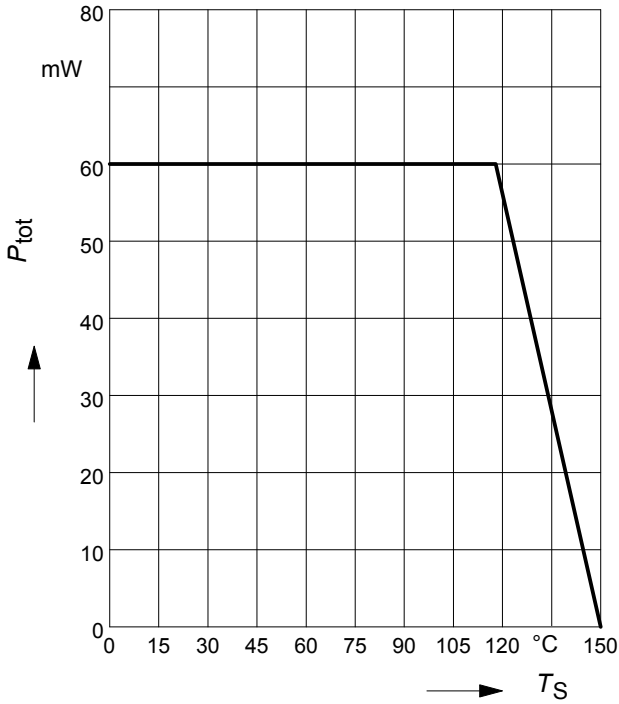

Permissible Pulse Load $R_{thJS} = f(t_p)$

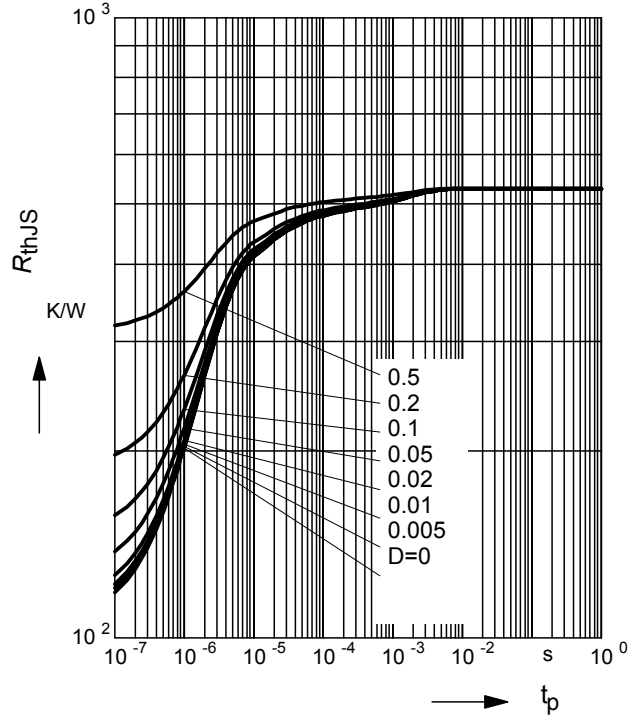

Permissible Pulse Load

$P_{totmax}/P_{totDC} = f(t_p)$

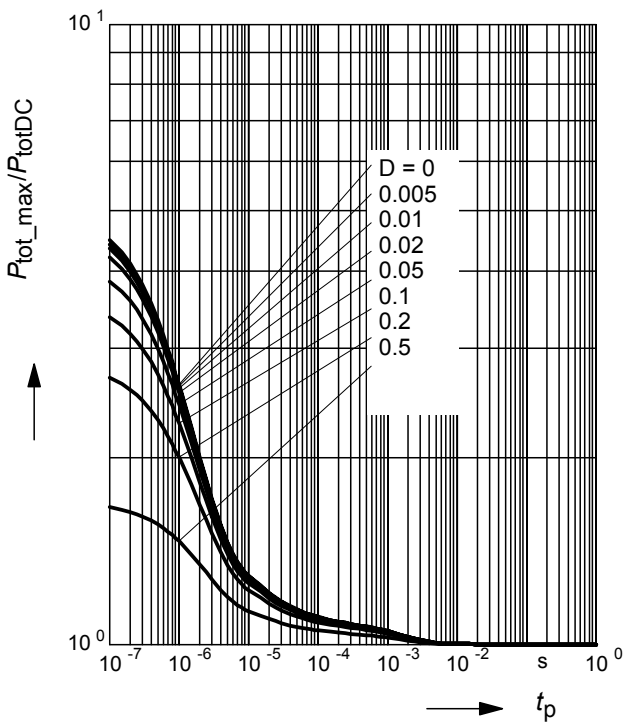

Collector-base capacitance $C_{cb} = f(V_{CB})$

$f = 1\text{MHz}$

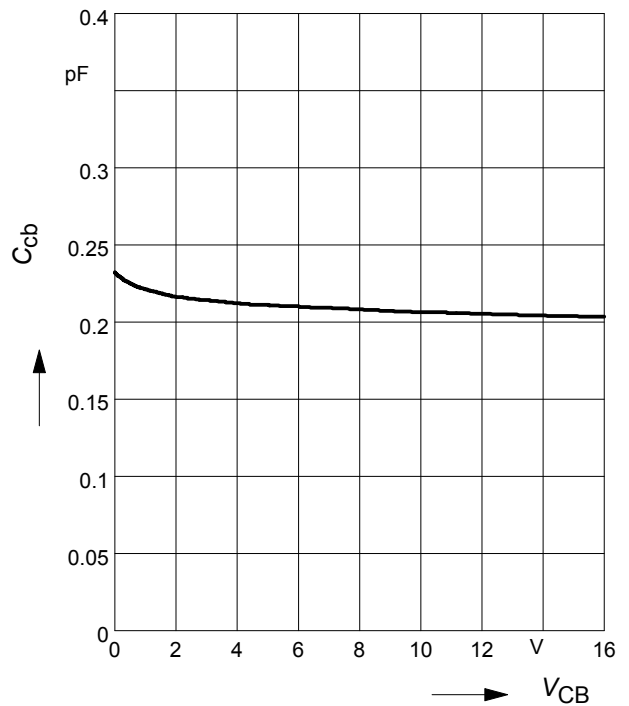

Third order Intercept Point $IP_3 = f(I_C)$

(Output, $Z_S = Z_L = 50\Omega$)

V_{CE} = parameter, $f = 1.8\text{GHz}$

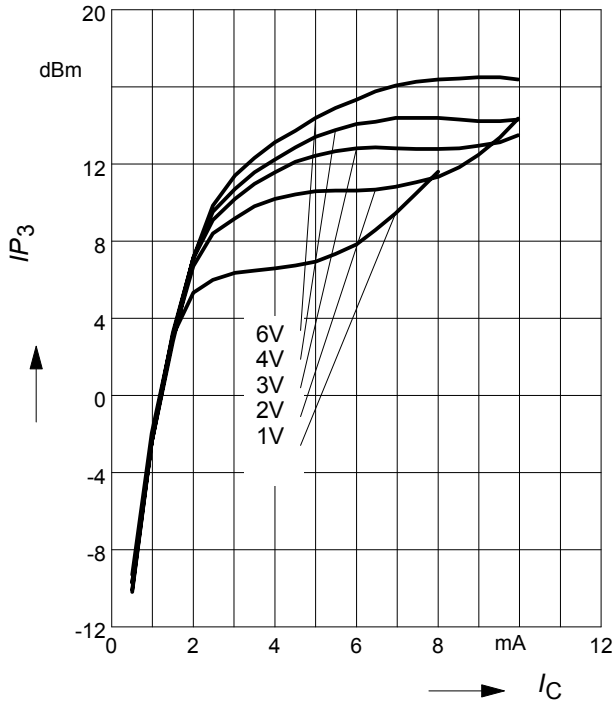

Transition frequency $f_T = f(I_C)$

$f = 1\text{GHz}$

V_{CE} = parameter

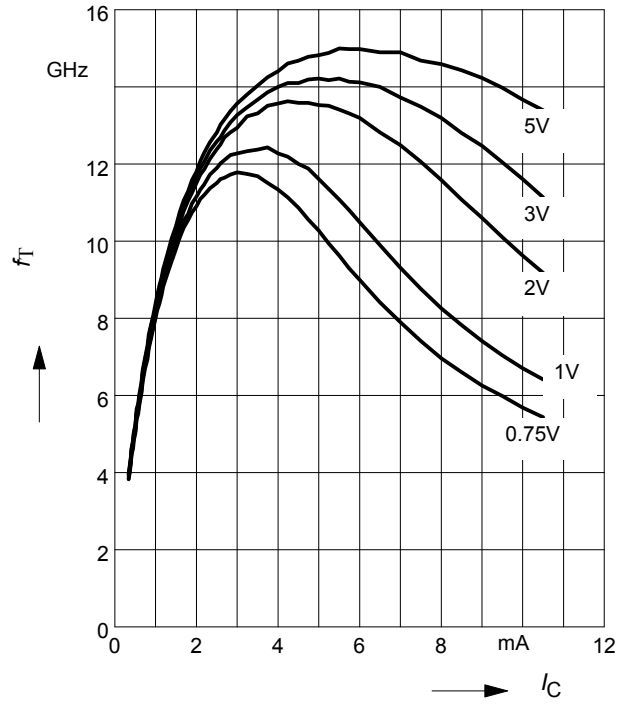

Power gain $G_{ma}, G_{ms} = f(I_C)$

$f = 0.9\text{GHz}$

V_{CE} = parameter

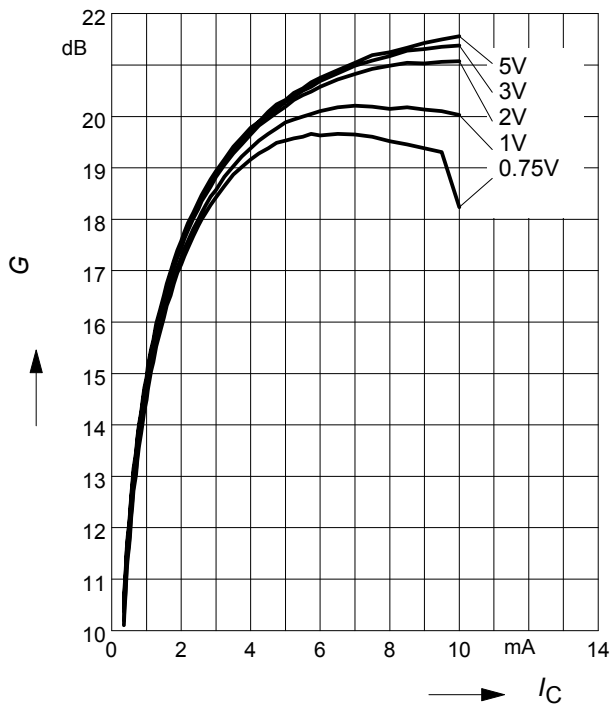

Power gain $G_{ma}, G_{ms} = f(I_C)$

$f = 1.8\text{GHz}$

V_{CE} = parameter

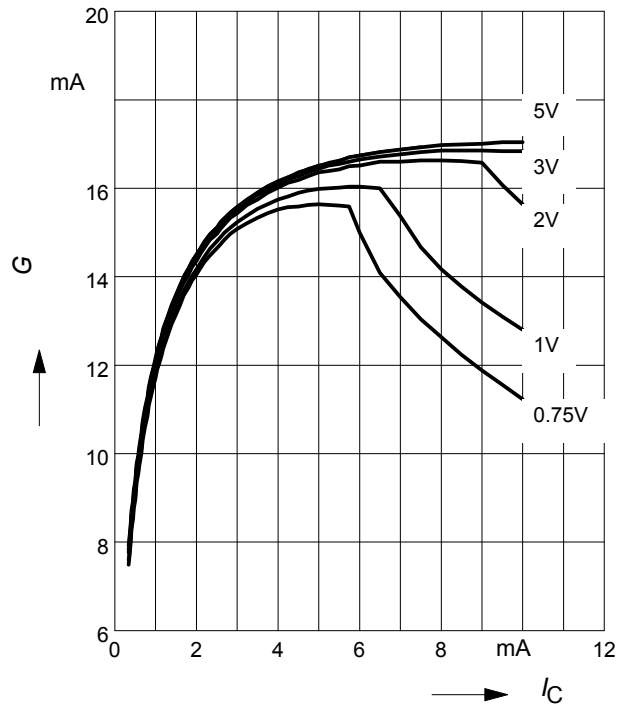

Power Gain $G_{ma}, G_{ms} = f(f)$
 $V_{CE} = \text{parameter}$

Insertion Power Gain $|S_{21}|^2 = f(f)$
 $V_{CE} = \text{parameter}$

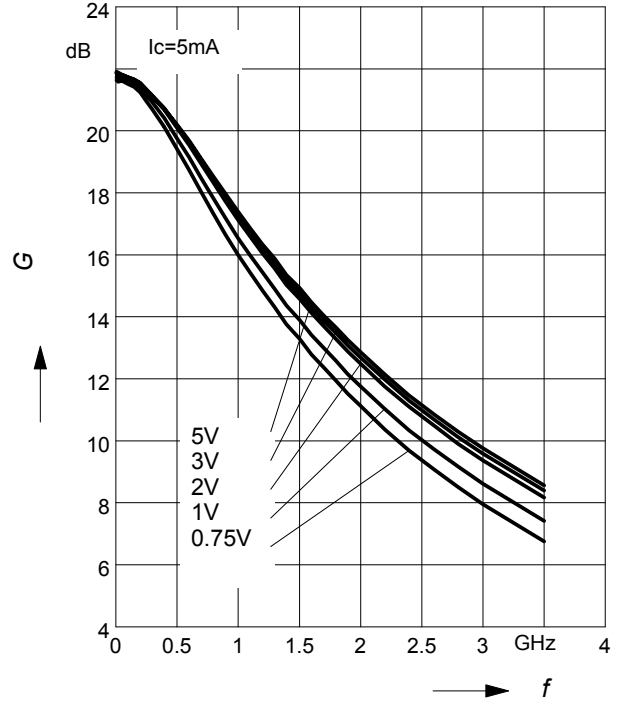
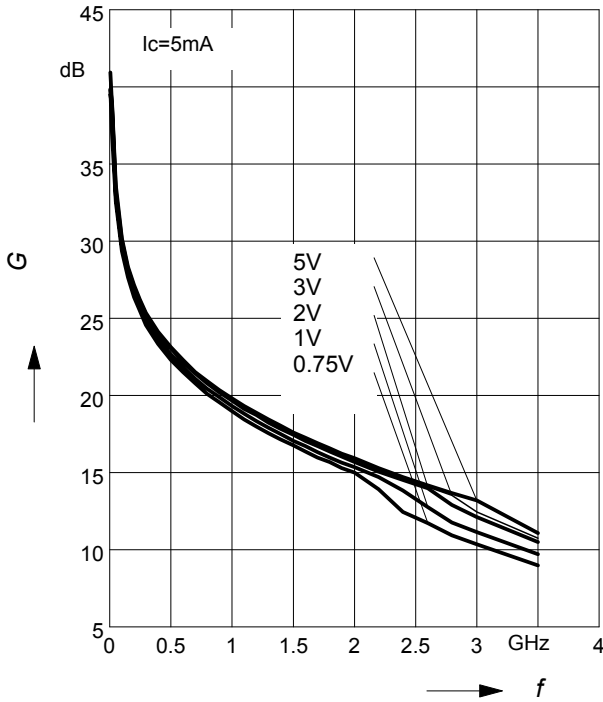

Power Gain $G_{ma}, G_{ms} = f(V_{CE})$: —
 $|S_{21}|^2 = f(V_{CE})$: - - - -
 $f = \text{parameter}$

Power gain $G_{ma}, G_{ms} = f(I_C)$
 $V_{CE} = 3V$
 $f = \text{parameter}$

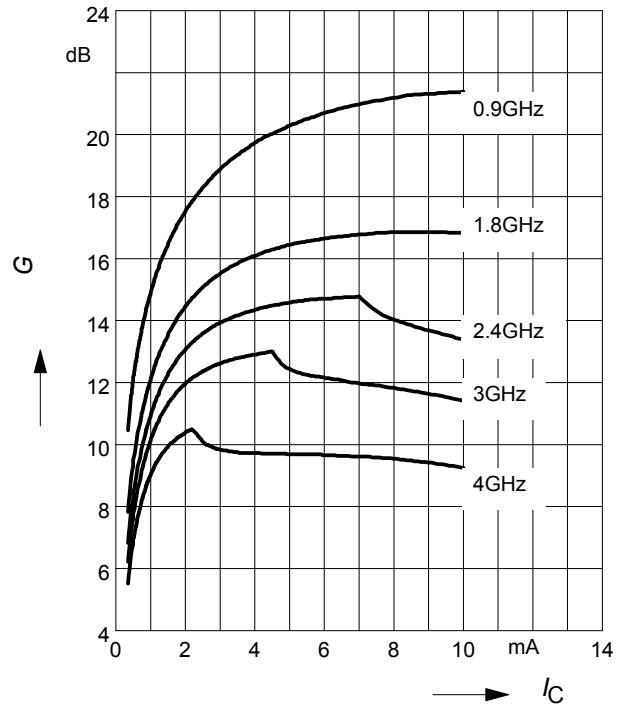
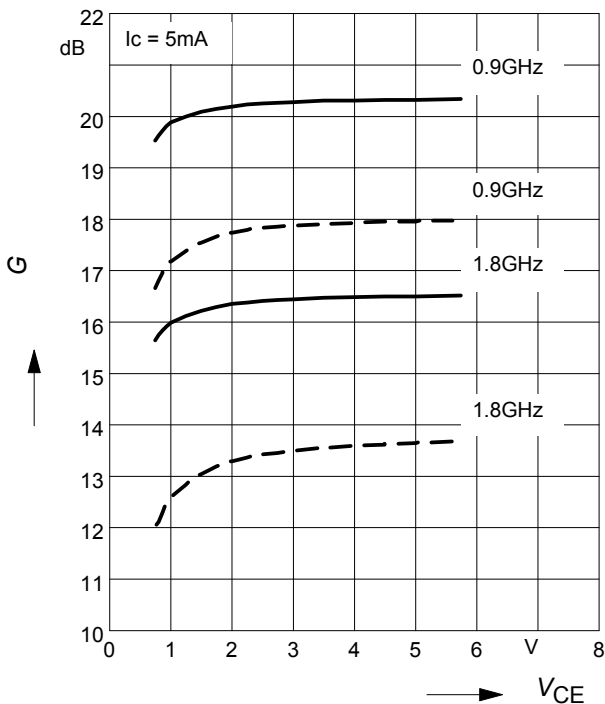

Noise figure $NF = f(I_C)$

$V_{CE} = 3V, f = 1,8 \text{ GHz}$

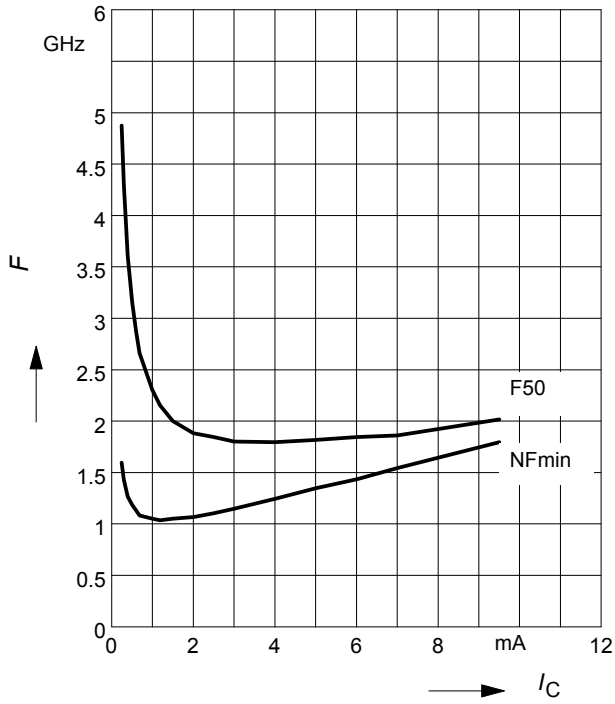

Source impedance for min.

noise figure vs. frequency

$V_{CE} = 3 \text{ V}$

