

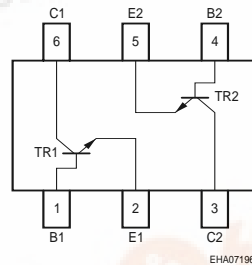

**BFS482**

**NPN Silicon RF Transistor**

- For low-noise, high-gain broadband amplifiers at collector currents from 0.2 mA to 20 mA
- $f_T = 8 \text{ GHz}$   
 $F = 1.2 \text{ dB}$  at 900 MHz
- Two (galvanic) internal isolated Transistors in one package

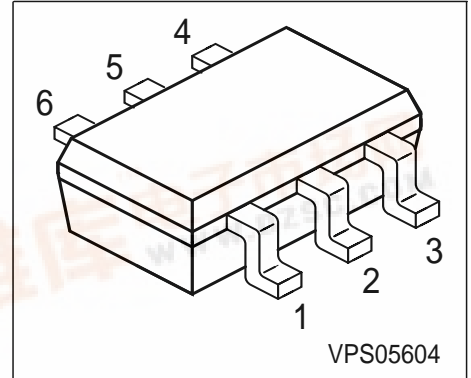

**ESD: Electrostatic discharge sensitive device, observe handling precaution!**

Type	Marking	Pin Configuration					Package	
BFS482	RGs	1=B	2=E	3=C	4=B	5=E	6=C	SOT363

**Maximum Ratings**

Parameter	Symbol	Value	Unit
Collector-emitter voltage	$V_{CEO}$	12	V
Collector-emitter voltage	$V_{CES}$	20	
Collector-base voltage	$V_{CBO}$	20	
Emitter-base voltage	$V_{EBO}$	2	
Collector current	$I_C$	35	mA
Base current	$I_B$	4	
Total power dissipation $T_S \leq 81 \text{ }^\circ\text{C}^1)$	$P_{tot}$	250	mW
Junction temperature	$T_j$	150	$^\circ\text{C}$
Ambient temperature	$T_A$	-65 ... 150	
Storage temperature	$T_{stg}$	-65 ... 150	

**Thermal Resistance**

Junction - soldering point <sup>2)</sup>	$R_{thJS}$	$\leq 275$	K/W
--	------------	------------	-----

<sup>1</sup>  $T_S$  is measured on the collector lead at the soldering point to the pcb

<sup>2</sup> For calculation of  $R_{thJA}$  please refer to Application Note Thermal Resistance



**Electrical Characteristics** at  $T_A = 25^\circ\text{C}$ , unless otherwise specified.

Parameter	Symbol	Values			Unit
		min.	typ.	max.	
<b>DC characteristics</b>					
Collector-emitter breakdown voltage $I_C = 1 \text{ mA}, I_B = 0$	$V_{(BR)CEO}$	12	-	-	V
Collector-emitter cutoff current $V_{CE} = 20 \text{ V}, V_{BE} = 0$	$I_{CES}$	-	-	100	$\mu\text{A}$
Collector-base cutoff current $V_{CB} = 10 \text{ V}, I_E = 0$	$I_{CBO}$	-	-	100	nA
Emitter-base cutoff current $V_{EB} = 1 \text{ V}, I_C = 0$	$I_{EBO}$	-	-	1	$\mu\text{A}$
DC current gain $I_C = 10 \text{ mA}, V_{CE} = 8 \text{ V}$	$h_{FE}$	50	100	200	-

**Electrical Characteristics** at  $T_A = 25^\circ\text{C}$ , unless otherwise specified.

Parameter	Symbol	Values			Unit
		min.	typ.	max.	
<b>AC characteristics</b> (verified by random sampling)					
Transition frequency $I_C = 15\text{ mA}$ , $V_{CE} = 8\text{ V}$ , $f = 500\text{ MHz}$	$f_T$	6	8	-	GHz
Collector-base capacitance $V_{CB} = 10\text{ V}$ , $f = 1\text{ MHz}$	$C_{cb}$	-	0.3	0.45	pF
Collector-emitter capacitance $V_{CE} = 10\text{ V}$ , $f = 1\text{ MHz}$	$C_{ce}$	-	0.12	-	
Emitter-base capacitance $V_{EB} = 0.5\text{ V}$ , $f = 1\text{ MHz}$	$C_{eb}$	-	0.65	-	
Noise figure $I_C = 3\text{ mA}$ , $V_{CE} = 8\text{ V}$ , $Z_S = Z_{\text{Sopt}}$ , $f = 900\text{ MHz}$ $f = 1.8\text{ GHz}$	$F$	-	1.2	-	dB
		-	1.9	-	
Power gain, maximum stable <sup>1)</sup> $I_C = 10\text{ mA}$ , $V_{CE} = 8\text{ V}$ , $Z_S = Z_{\text{Sopt}}$ , $Z_L = Z_{\text{Lopt}}$ , $f = 900\text{ MHz}$	$G_{\text{ms}}$	-	19.5	-	
Power gain, maximum available <sup>2)</sup> $I_C = 10\text{ mA}$ , $V_{CE} = 8\text{ V}$ , $Z_S = Z_{\text{Sopt}}$ , $Z_L = Z_{\text{Lopt}}$ , $f = 1.8\text{ GHz}$	$G_{\text{ma}}$	-	13	-	
Transducer gain $I_C = 10\text{ mA}$ , $V_{CE} = 8\text{ V}$ , $Z_S = Z_L = 50\Omega$ , $f = 900\text{ MHz}$ $f = 1.8\text{ GHz}$	$ S_{21e} ^2$	-	15.5	-	
		-	10	-	

$$^1G_{\text{ms}} = |S_{21} / S_{12}|$$

$$^2G_{\text{ma}} = |S_{21} / S_{12}| (k - (k^2 - 1)^{1/2})$$

**Total power dissipation  $P_{tot} = f(T_S)$**

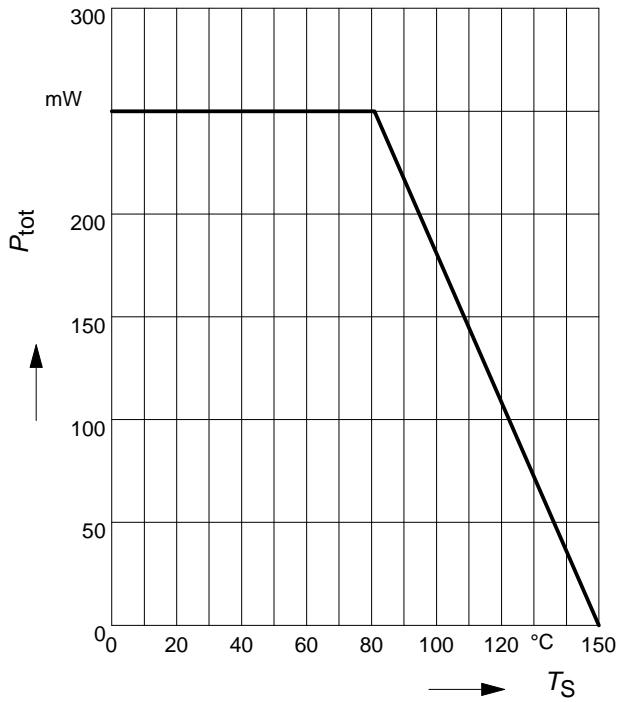

**Permissible Pulse Load  $R_{thJS} = f(t_p)$**

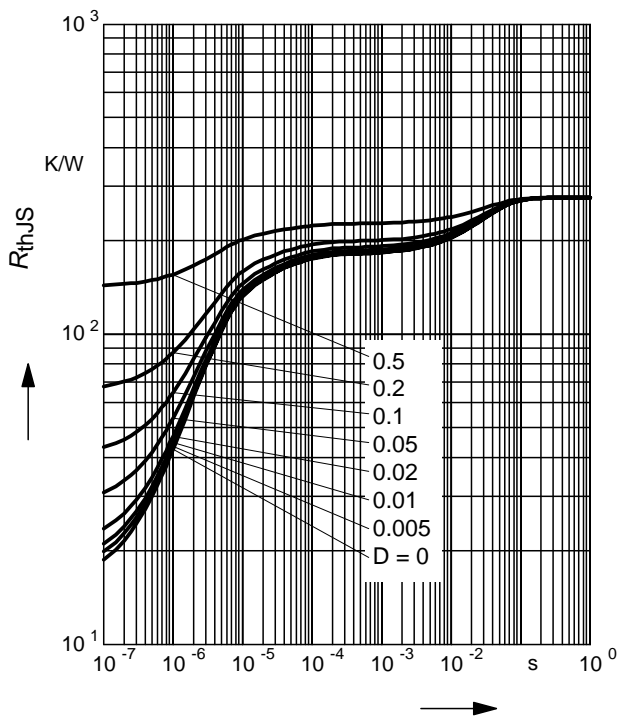

**Permissible Pulse Load**

$P_{totmax}/P_{totDC} = f(t_p)$

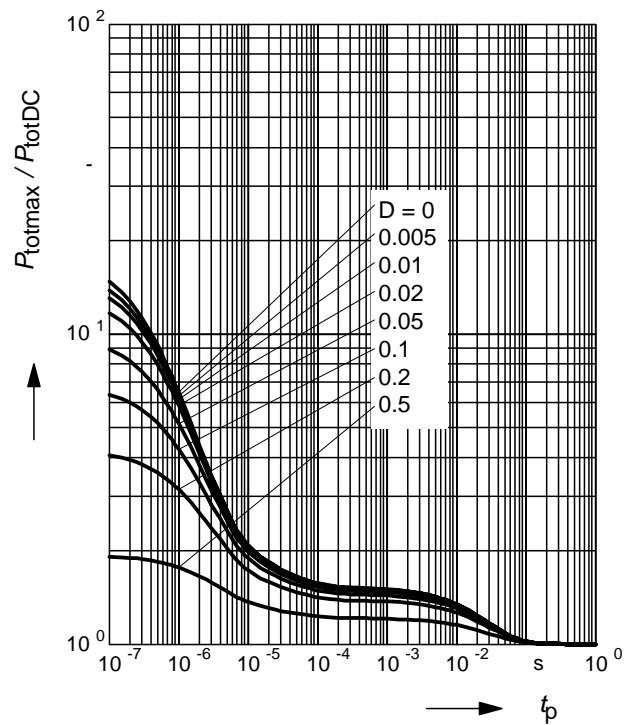

**Collector-base capacitance  $C_{cb} = f(V_{CB})$**

$f = 1\text{MHz}$

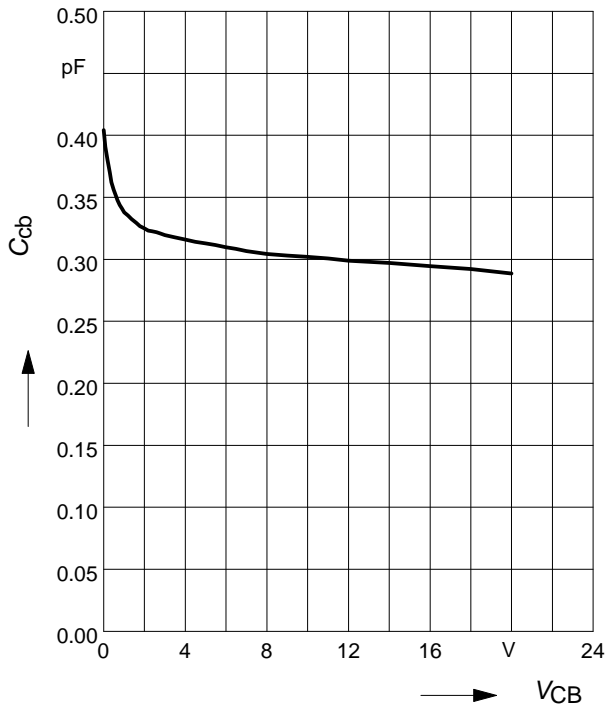

**Transition frequency  $f_T = f(I_C)$**

$V_{CE} = \text{Parameter}$

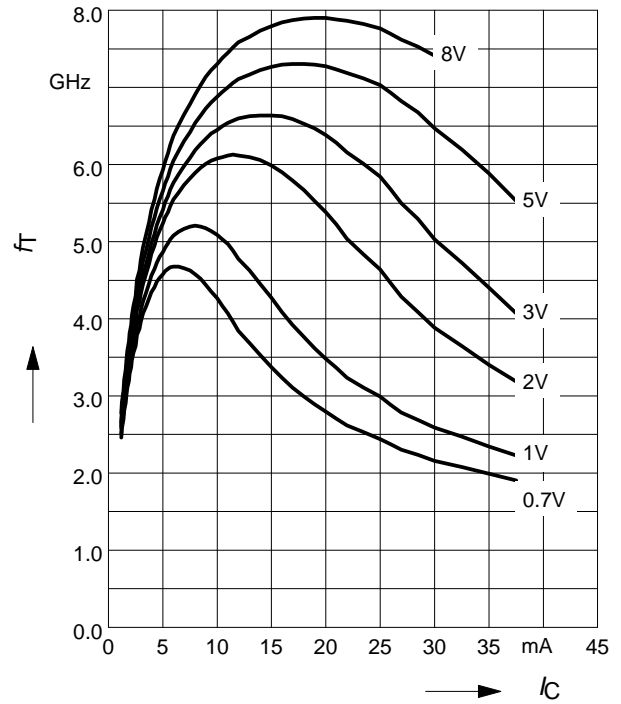

**Power Gain  $G_{ma}, G_{ms} = f(I_C)$**

$f = 0.9\text{GHz}$

$V_{CE} = \text{Parameter}$

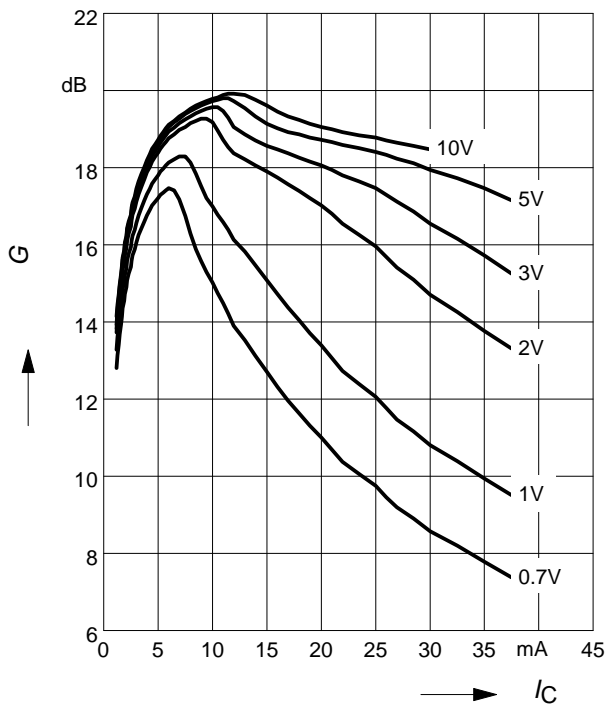

**Power Gain  $G_{ma}, G_{ms} = f(I_C)$**

$f = 1.8\text{GHz}$

$V_{CE} = \text{Parameter}$

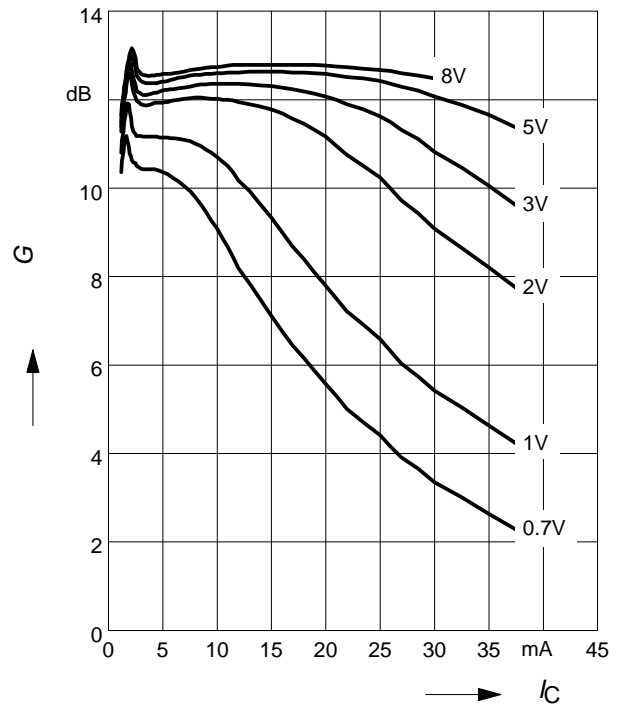

**Power Gain**  $G_{ma}, G_{ms} = f(V_{CE})$ : \_\_\_\_\_  
 $|S_{21}|^2 = f(V_{CE})$ : -----

$f$  = Parameter

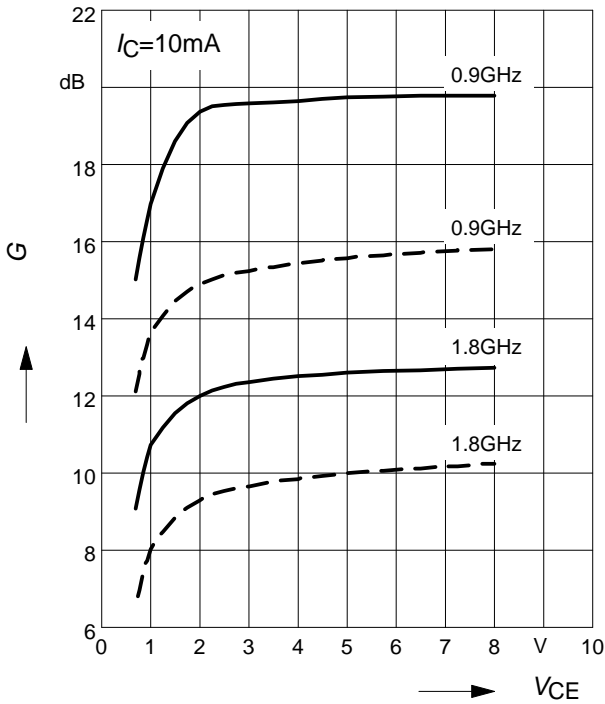

**Intermodulation Intercept Point**  $IP_3 = f(I_C)$   
 (3rd order, Output,  $Z_S = Z_L = 50\Omega$ )

$V_{CE}$  = Parameter,  $f = 900\text{MHz}$

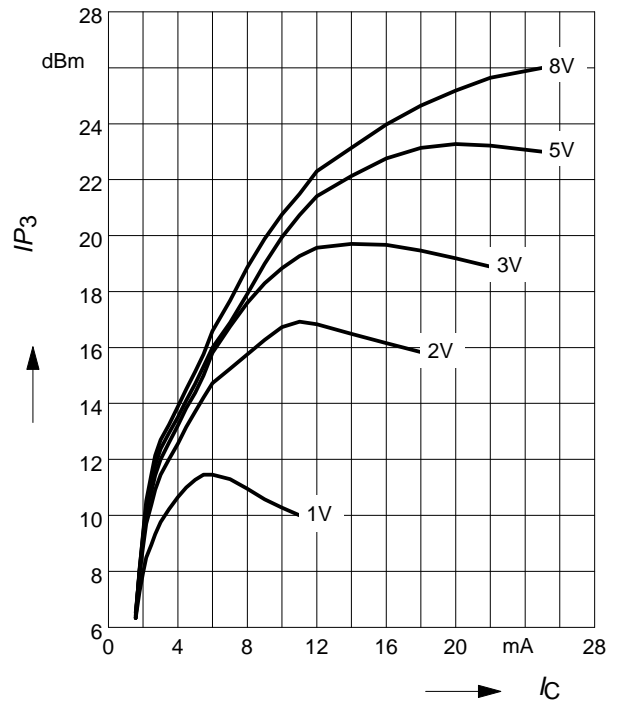

**Power Gain**  $G_{ma}, G_{ms} = f(f)$

$V_{CE}$  = Parameter

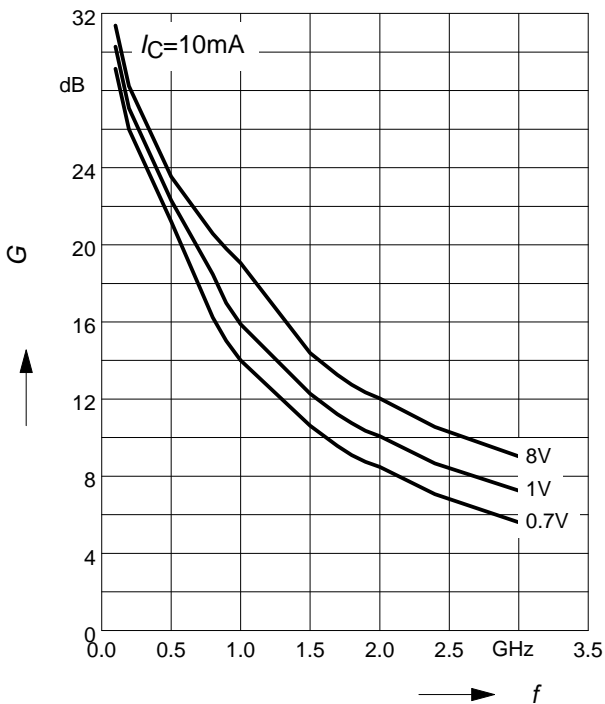

**Power Gain**  $|S_{21}|^2 = f(f)$

$V_{CE}$  = Parameter

