

DISCRETE SEMICONDUCTORS

DATA SHEET

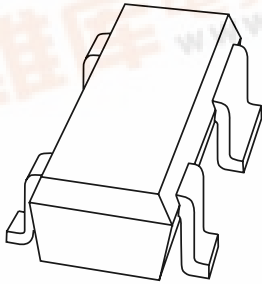

BFU540

NPN SiGe wideband transistor

Product specification
Supersedes data of 2002 Jan 28

2003 Jun 12

NPN SiGe wideband transistor

BFU540

FEATURES

- Very high power gain
- Very low noise figure
- High transition frequency
- Emitter is thermal lead
- Low feedback capacitance
- 45 GHz SiGe process.

APPLICATIONS

- RF front end
- Wideband applications, e.g. analog and digital cellular telephones, cordless telephones (PHS, DECT, etc.)
- Radar detectors
- Pagers
- Satellite television tuners (SATV)
- High frequency oscillators.

DESCRIPTION

NPN SiGe wideband transistor for low voltage applications in a plastic, 4-pin dual-emitter SOT343R package.

PINNING

PIN	DESCRIPTION
1	emitter
2	base
3	emitter
4	collector

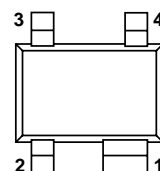

Top view MSB842

Marking code: A4.

Fig.1 Simplified outline SOT343R.

QUICK REFERENCE DATA

SYMBOL	PARAMETER	CONDITIONS	MIN.	TYP.	MAX.	UNIT
V_{CB0}	collector-base voltage	open emitter	–	–	9	V
V_{CEO}	collector-emitter voltage	open base	–	–	2.3	V
I_C	collector current (DC)		–	40	50	mA
P_{tot}	total power dissipation	$T_s \leq 98\text{ °C}$	–	–	115	mW
h_{FE}	DC current gain	$I_C = 40\text{ mA}; V_{CE} = 2\text{ V}; T_J = 25\text{ °C}$	70	140	210	
G_{max}	maximum power gain	$I_C = 40\text{ mA}; V_{CE} = 2\text{ V}; f = 2\text{ GHz}; T_{amb} = 25\text{ °C}$	–	20	–	dB
NF	noise figure	$I_C = 2\text{ mA}; V_{CE} = 2\text{ V}; f = 2\text{ GHz}; \Gamma_S = \Gamma_{opt}$	–	0.9	–	dB

CAUTION

This product is supplied in anti-static packing to prevent damage caused by electrostatic discharge during transport and handling. For further information, refer to Philips specs.: SNW-EQ-608, SNW-FQ-302A and SNW-FQ-302B.

NPN SiGe wideband transistor

BFU540

LIMITING VALUES

In accordance with the Absolute Maximum Rating System (IEC 60134).

SYMBOL	PARAMETER	CONDITIONS	MIN.	MAX.	UNIT
V _{CBO}	collector-base voltage	open emitter	–	9	V
V _{CEO}	collector-emitter voltage	open base	–	2.3	V
V _{EBO}	emitter-base voltage	open collector	–	2.5	V
I _C	collector current (DC)		–	50	mA
P _{tot}	total power dissipation	T _s ≤ 98 °C; note 1; see Fig.2	–	115	mW
T _{stg}	storage temperature		–65	+150	°C
T _j	operating junction temperature		–	150	°C

Note

1. T_s is the temperature at the soldering point of the emitter pins.

THERMAL CHARACTERISTICS

SYMBOL	PARAMETER	VALUE	UNIT
R _{th j-s}	thermal resistance from junction to soldering point	450	K/W

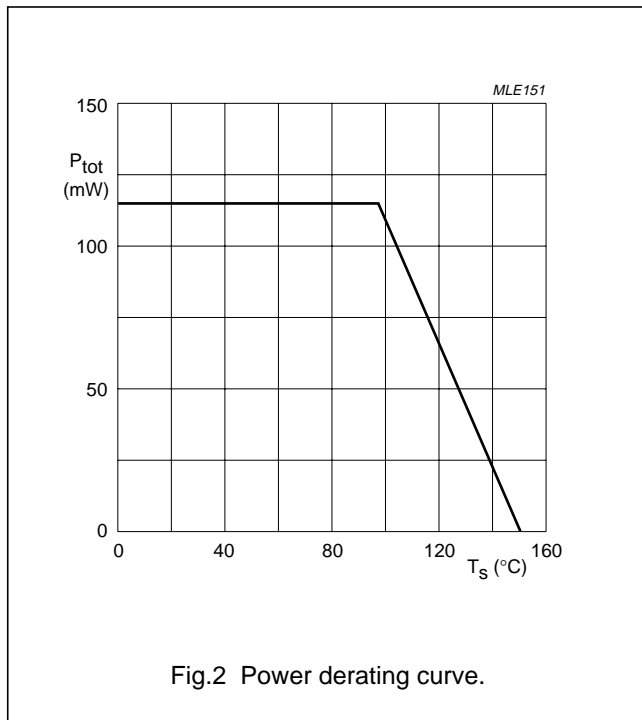

Fig.2 Power derating curve.

NPN SiGe wideband transistor

BFU540

CHARACTERISTICS

$T_j = 25\text{ }^\circ\text{C}$; unless otherwise specified.

SYMBOL	PARAMETER	CONDITIONS	MIN.	TYP.	MAX.	UNIT
$V_{(BR)CBO}$	collector-base breakdown voltage	$I_C = 2.5\text{ }\mu\text{A}$; $I_E = 0$	9	–	–	V
$V_{(BR)CEO}$	collector-emitter breakdown voltage	$I_C = 1\text{ mA}$; $I_B = 0$	2.3	–	–	V
$V_{(BR)EBO}$	emitter-base breakdown voltage	$I_E = 2.5\text{ }\mu\text{A}$; $I_C = 0$	2.5	–	–	V
I_{CBO}	collector-base leakage current	$I_E = 0$; $V_{CB} = 4.5\text{ V}$	–	–	15	nA
h_{FE}	DC current gain	$I_C = 40\text{ mA}$; $V_{CE} = 2\text{ V}$	70	140	210	
C_c	collector capacitance	$I_E = I_e = 0$; $V_{CB} = 2\text{ V}$; $f = 1\text{ MHz}$	–	520	–	fF
C_{re}	feedback capacitance	$I_C = 0$; $V_{CB} = 2\text{ V}$; $f = 1\text{ MHz}$	–	105	–	fF
G_{max}	maximum power gain; note 1	$I_C = 40\text{ mA}$; $V_{CE} = 2\text{ V}$; $f = 2\text{ GHz}$; $T_{amb} = 25\text{ }^\circ\text{C}$	–	20	–	dB
NF	noise figure	$I_C = 2\text{ mA}$; $V_{CE} = 2\text{ V}$; $f = 2\text{ GHz}$; $\Gamma_S = \Gamma_{opt}$	–	0.9	–	dB
P_{L1}	output power at 1 dB gain compression	$I_C = 20\text{ mA}$; $V_{CE} = 2\text{ V}$; $f = 2\text{ GHz}$; $Z_S = Z_{S\text{ opt}}$; $Z_L = Z_{L\text{ opt}}$; note 2	–	11	–	dBm
ITO	third order intercept point	$I_C = 40\text{ mA}$; $V_{CE} = 2\text{ V}$; $f = 2\text{ GHz}$; $Z_S = Z_{S\text{ opt}}$; $Z_L = Z_{L\text{ opt}}$; note 2	–	21	–	dBm

Notes

- G_{max} is the maximum power gain, if $K > 1$. If $K < 1$ then $G_{max} = \text{MSG}$.
- Z_S and Z_L are optimized for gain.

NPN SiGe wideband transistor

BFU540

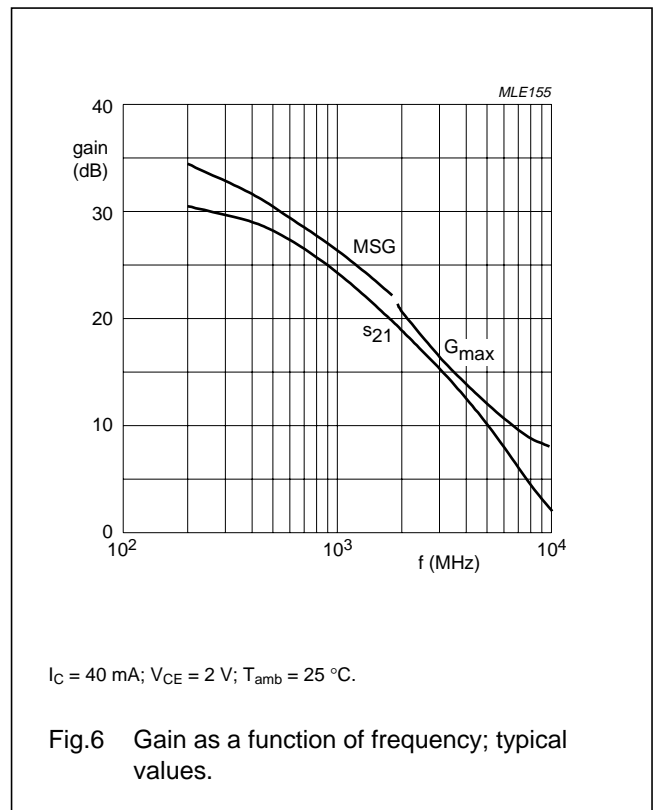
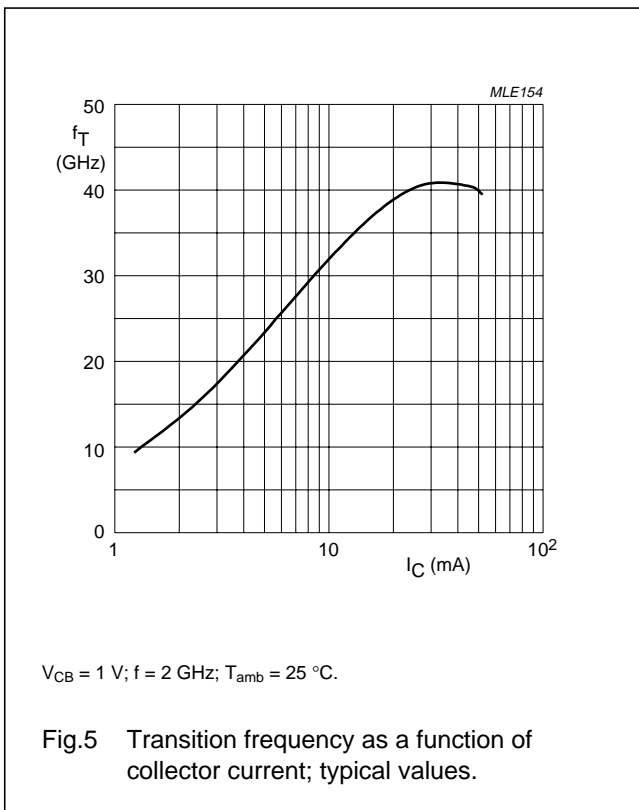
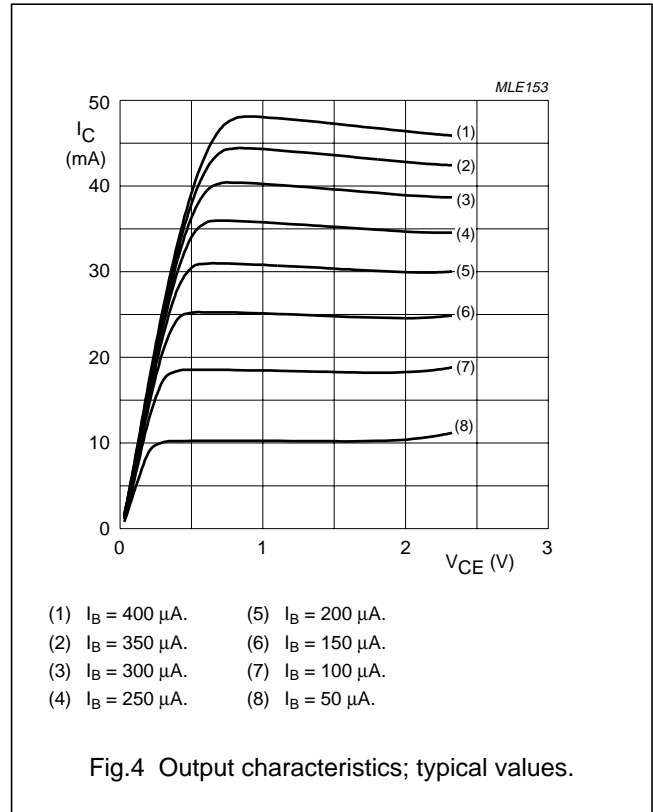
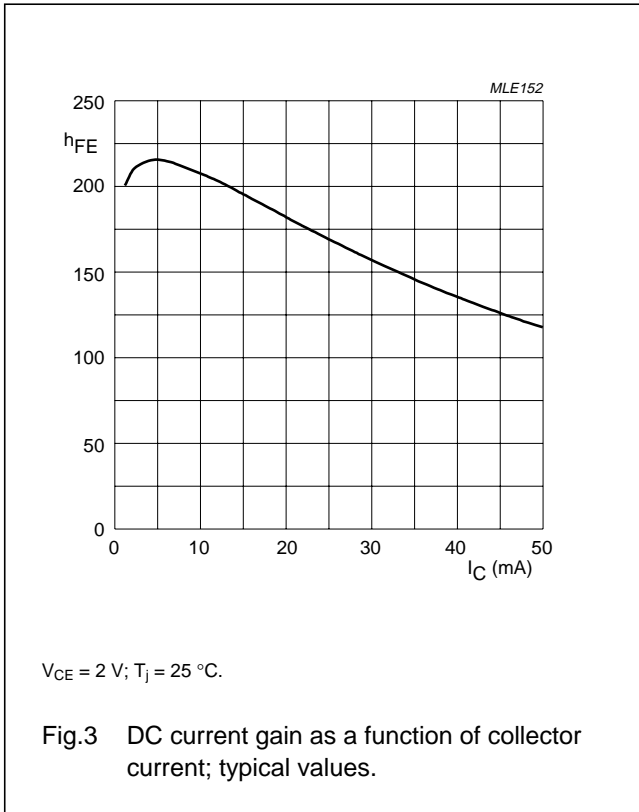

NPN SiGe wideband transistor

BFU540

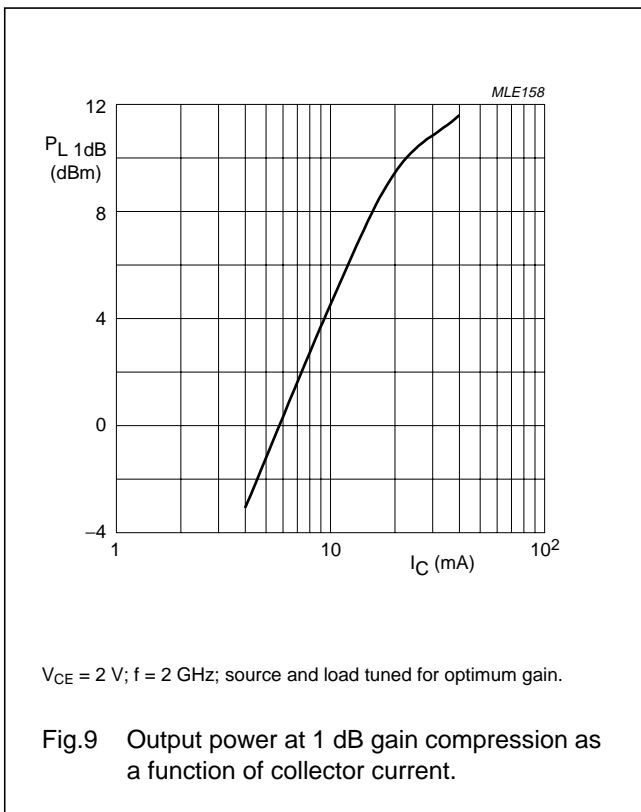
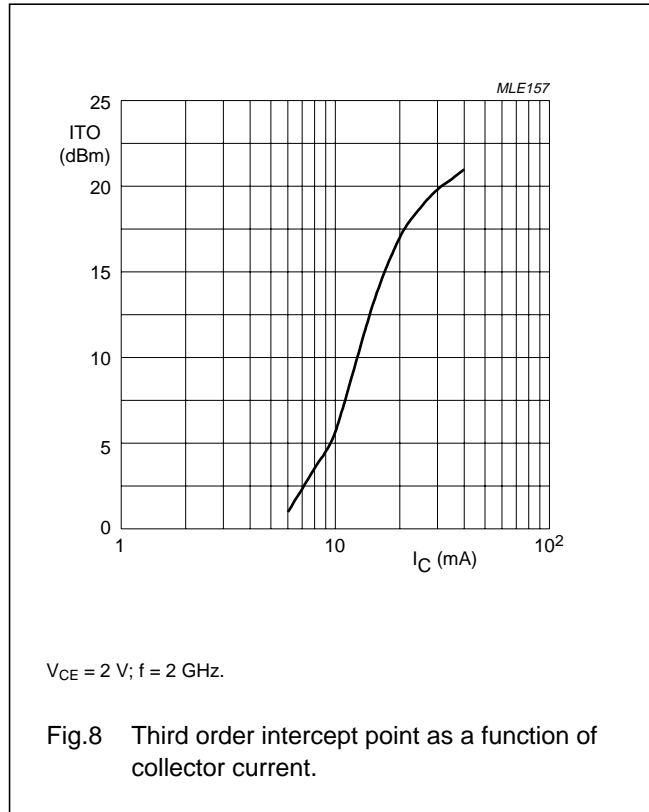
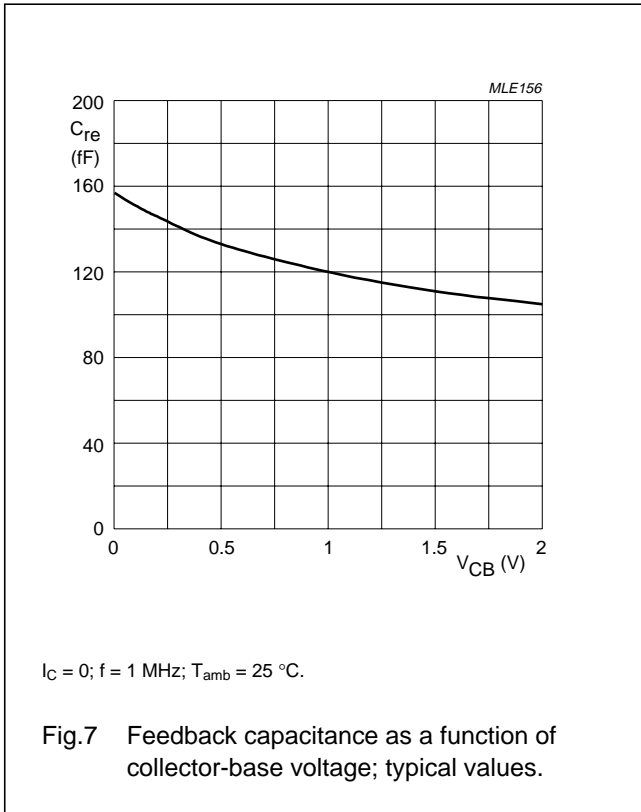

NPN SiGe wideband transistor

BFU540

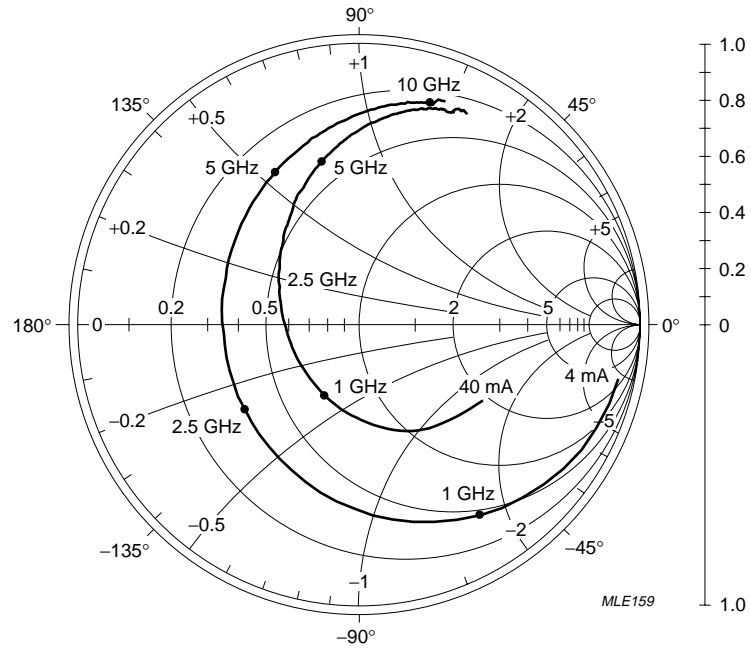

$I_C = 4 \text{ mA}$ and 40 mA ; $V_{CE} = 2 \text{ V}$; $Z_0 = 50 \Omega$.

Fig.10 Common emitter input reflection coefficient (s_{11}).

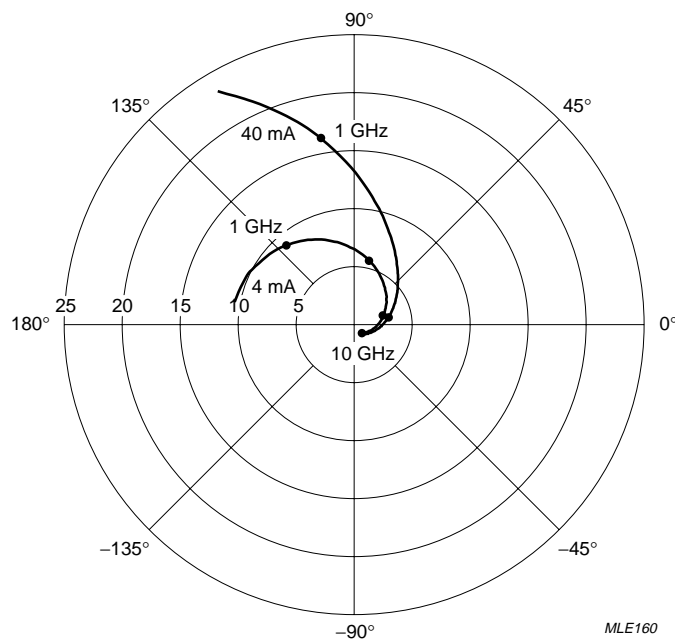

$I_C = 4 \text{ mA}$ and 40 mA ; $V_{CE} = 2 \text{ V}$; $Z_0 = 50 \Omega$.

Fig.11 Common emitter forward transmission coefficient (s_{21}).

NPN SiGe wideband transistor

BFU540

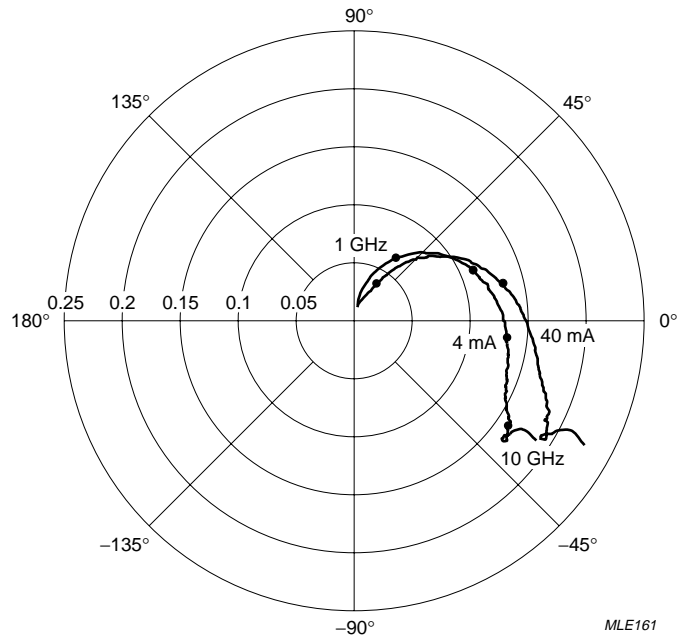

$I_C = 4 \text{ mA and } 40 \text{ mA}; V_{CE} = 2 \text{ V}; Z_o = 50 \Omega.$

Fig.12 Common emitter reverse transmission coefficient (s_{12}).

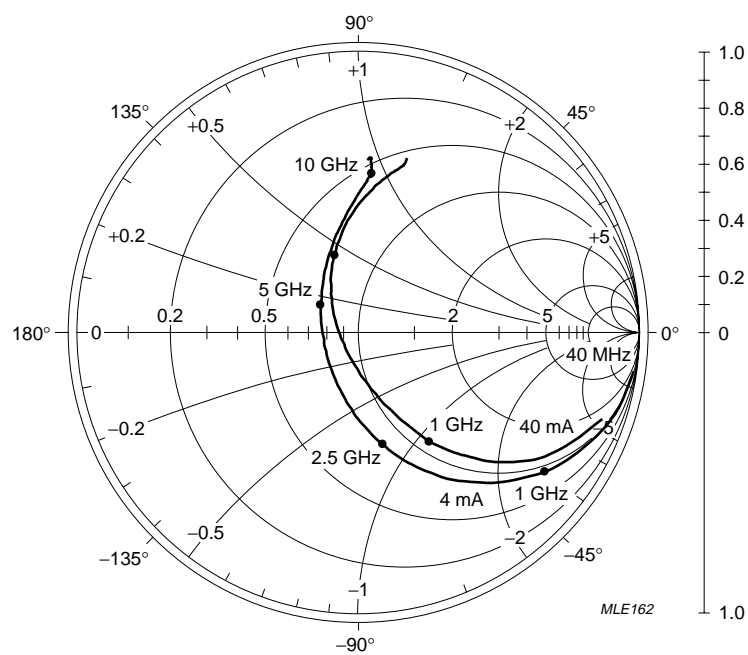

$I_C = 4 \text{ mA and } 40 \text{ mA}; V_{CE} = 2 \text{ V}; Z_o = 50 \Omega.$

Fig.13 Common emitter output reflection coefficient (s_{22}).

NPN SiGe wideband transistor

BFU540

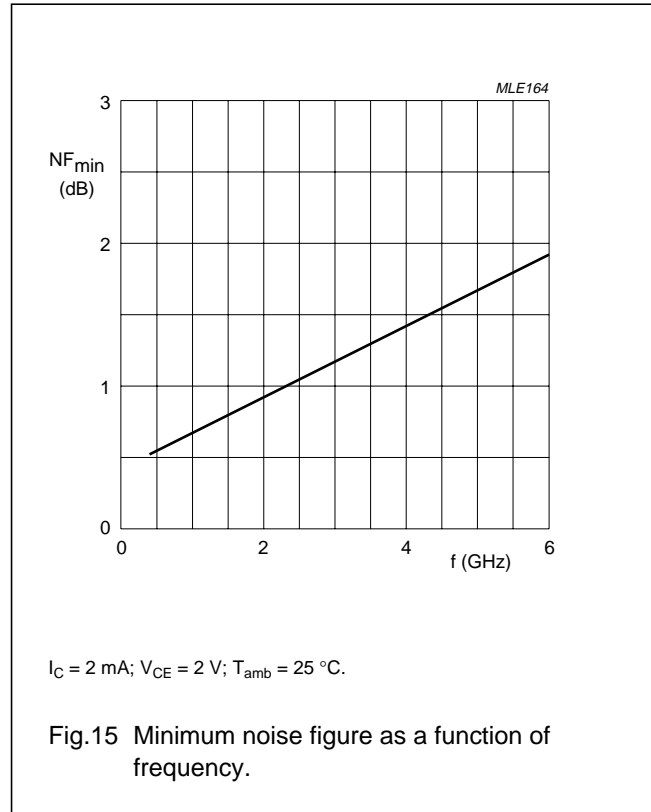
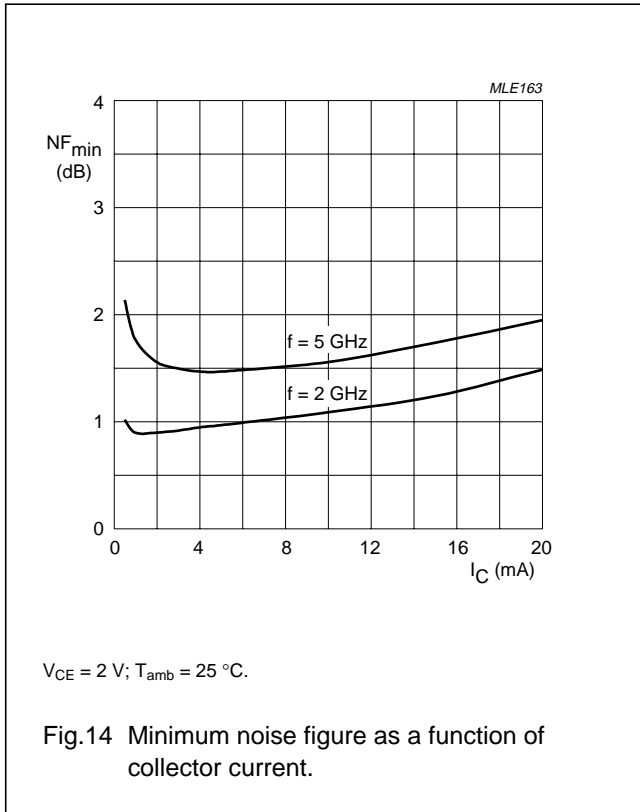

Noise data: $V_{CE} = 2$ V; $I_C = 4$ mA; $T_{amb} = 25$ °C; typical values

f (GHz)	F _{min} (dB)	Γ _{opt}		r _n (Ω)
		(mag)	(deg)	
2	1.0	0.39	55.9	0.20
3	1.2	0.23	86.8	0.15
4	1.4	0.11	142.5	0.13
5	1.6	0.14	-121.0	0.16
6	1.7	0.28	-74.2	0.27
7	1.9	0.41	-52.1	0.43
8	2.1	0.47	-32.6	0.66
9	2.3	0.54	-14.1	0.91
10	2.6	0.62	3.7	1.22
11	2.8	0.63	22.7	1.44
12	3.0	0.61	36.8	1.65

NPN SiGe wideband transistor

BFU540

SPICE parameters for the BFU540 die

SEQUENCE No.	PARAMETER	VALUE	UNIT
1	IS	1.5	aA
2	BF	271.5	–
3	NF	1.061	–
4	VAF	25	V
5	IKF	68	mA
6	ISE	1060	fA
7	NE	2.9	–
8	BR	50	–
9	NR	1.01	–
10	VAR	1	MV
11	IKR	6.4	mA
12	ISC	1.2	fA
13	NC	1.21	–
14	RB	8.75	Ω
15 ⁽¹⁾	IRB	–	–
16	RBM	5	Ω
17	RE	0.9	m Ω
18	RC	9.25	Ω
19	XTB	–2.2	–
20	EG	1.014	eV
21	XTI	3	–
22	CJE	222	fF
23	VJE	918	mV
24	MJE	0.27	–
25	TF	2.1	ps
26	XTF	10	–
27	VTF	1.5	V
28	ITF	0.92	A
29	PTF	30	deg
30	CJC	147	fF
31	VJC	587	mV
32	MJC	0.246	–
33	XCJC	0.44	–
34	TR	20	ps
35	CJS	51	fF
36	VJS	441	mV
37	MJS	0.313	–
38	FC	0.7	–

Note

1. Not used.

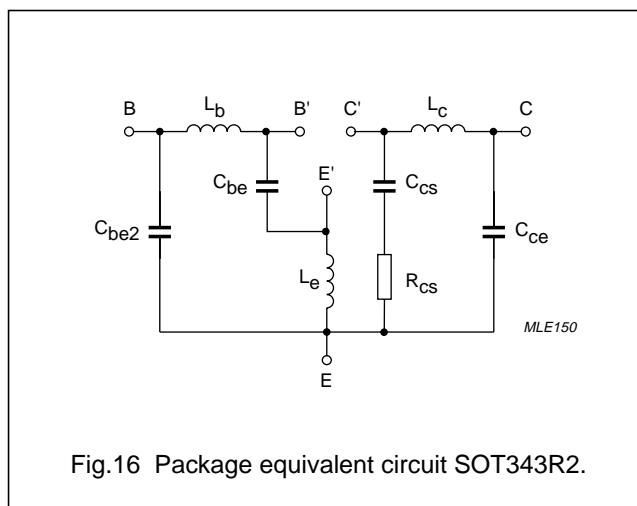

Fig.16 Package equivalent circuit SOT343R2.

List of components (see Fig.16)

DESIGNATION	VALUE	UNIT
L_b	1.18	nH
L_c	1.04	nH
L_e	0.32	nH
C_{be1}	146	fF
C_{be2}	55	fF
C_{ce}	56	fF
C_{cs}	100	fF
R_{cs}	170	Ω

NPN SiGe wideband transistor

BFU540

PACKAGE OUTLINE

Plastic surface mounted package; reverse pinning; 4 leads

SOT343R

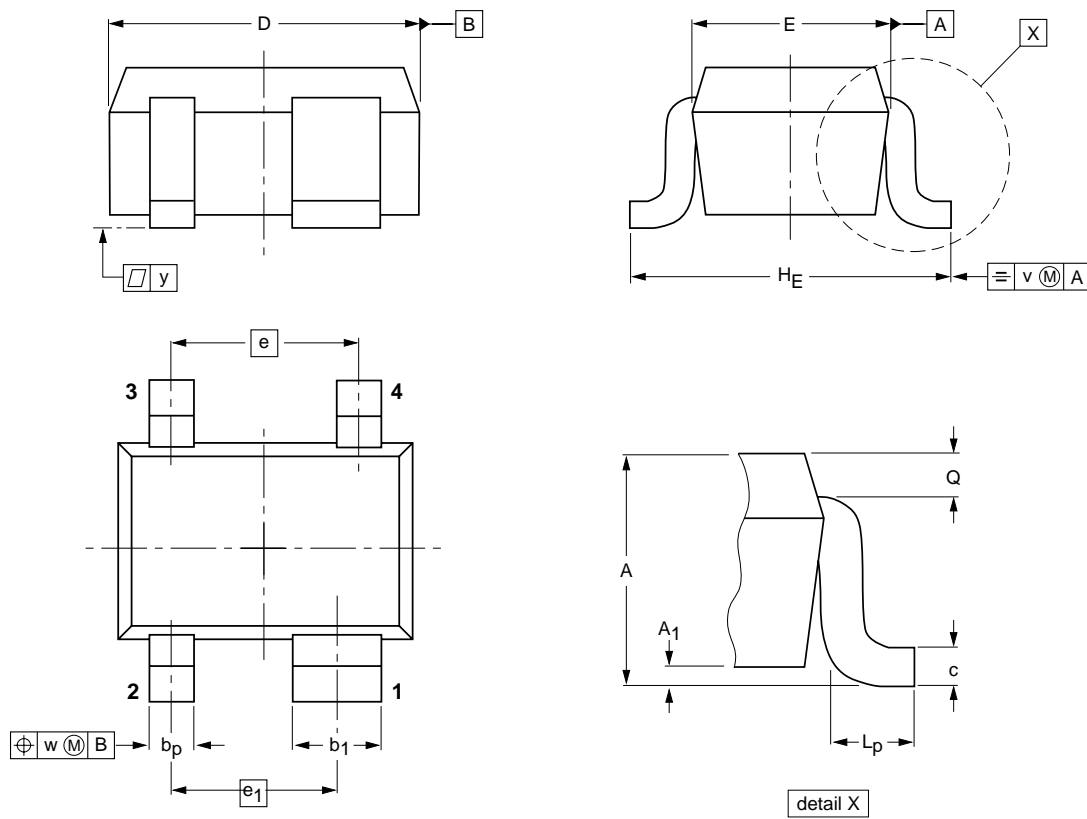

DIMENSIONS (mm are the original dimensions)

UNIT	A	A ₁ max	b _p	b ₁	c	D	E	e	e ₁	H _E	L _p	Q	v	w	y
mm	1.1 0.8	0.1	0.4 0.3	0.7 0.5	0.25 0.10	2.2 1.8	1.35 1.15	1.3	1.15	2.2 2.0	0.45 0.15	0.23 0.13	0.2	0.2	0.1

OUTLINE VERSION	REFERENCES				EUROPEAN PROJECTION	ISSUE DATE
	IEC	JEDEC	EIAJ			
SOT343R						97-05-21

NPN SiGe wideband transistor

BFU540

DATA SHEET STATUS

LEVEL	DATA SHEET STATUS ⁽¹⁾	PRODUCT STATUS ⁽²⁾⁽³⁾	DEFINITION
I	Objective data	Development	This data sheet contains data from the objective specification for product development. Philips Semiconductors reserves the right to change the specification in any manner without notice.
II	Preliminary data	Qualification	This data sheet contains data from the preliminary specification. Supplementary data will be published at a later date. Philips Semiconductors reserves the right to change the specification without notice, in order to improve the design and supply the best possible product.
III	Product data	Production	This data sheet contains data from the product specification. Philips Semiconductors reserves the right to make changes at any time in order to improve the design, manufacturing and supply. Relevant changes will be communicated via a Customer Product/Process Change Notification (CPCN).

Notes

1. Please consult the most recently issued data sheet before initiating or completing a design.
2. The product status of the device(s) described in this data sheet may have changed since this data sheet was published. The latest information is available on the Internet at URL <http://www.semiconductors.philips.com>.
3. For data sheets describing multiple type numbers, the highest-level product status determines the data sheet status.

DEFINITIONS

Short-form specification — The data in a short-form specification is extracted from a full data sheet with the same type number and title. For detailed information see the relevant data sheet or data handbook.

Limiting values definition — Limiting values given are in accordance with the Absolute Maximum Rating System (IEC 60134). Stress above one or more of the limiting values may cause permanent damage to the device. These are stress ratings only and operation of the device at these or at any other conditions above those given in the Characteristics sections of the specification is not implied. Exposure to limiting values for extended periods may affect device reliability.

Application information — Applications that are described herein for any of these products are for illustrative purposes only. Philips Semiconductors make no representation or warranty that such applications will be suitable for the specified use without further testing or modification.

DISCLAIMERS

Life support applications — These products are not designed for use in life support appliances, devices, or systems where malfunction of these products can reasonably be expected to result in personal injury. Philips Semiconductors customers using or selling these products for use in such applications do so at their own risk and agree to fully indemnify Philips Semiconductors for any damages resulting from such application.

Right to make changes — Philips Semiconductors reserves the right to make changes in the products - including circuits, standard cells, and/or software - described or contained herein in order to improve design and/or performance. When the product is in full production (status 'Production'), relevant changes will be communicated via a Customer Product/Process Change Notification (CPCN). Philips Semiconductors assumes no responsibility or liability for the use of any of these products, conveys no licence or title under any patent, copyright, or mask work right to these products, and makes no representations or warranties that these products are free from patent, copyright, or mask work right infringement, unless otherwise specified.

NPN SiGe wideband transistor

BFU540

NOTES

NPN SiGe wideband transistor

BFU540

NOTES

NPN SiGe wideband transistor

BFU540

NOTES

Philips Semiconductors – a worldwide company

Contact information

For additional information please visit <http://www.semiconductors.philips.com>. Fax: **+31 40 27 24825**

For sales offices addresses send e-mail to: sales.addresses@www.semiconductors.philips.com.

© Koninklijke Philips Electronics N.V. 2003

SCA75

All rights are reserved. Reproduction in whole or in part is prohibited without the prior written consent of the copyright owner.

The information presented in this document does not form part of any quotation or contract, is believed to be accurate and reliable and may be changed without notice. No liability will be accepted by the publisher for any consequence of its use. Publication thereof does not convey nor imply any license under patent- or other industrial or intellectual property rights.

Printed in The Netherlands

613516/04/pp16

Date of release: 2003 Jun 12

Document order number: 9397 750 11468

Let's make things better.

Philips



PHILIPS