

BGM1013

MMIC wideband amplifier

Rev. 03 — 9 December 2004

Product data sheet

1. Product profile

1.1 General description

Silicon Monolithic Microwave Integrated Circuit (MMIC) wideband amplifier with internal matching circuit in a 6-pin SOT363 SMD plastic package.

CAUTION



This device is sensitive to electrostatic discharge (ESD). Therefore care should be taken during transport and handling.

1.2 Features

- Internally matched to 50 Ω
- Good output match to 75 Ω
- Very high gain; 35.5 dB at 1 GHz
- Upper corner frequency at 2.1 GHz
- 31 dB flat gain up to 2.2 GHz application
- 14 dBm saturated output power at 1 GHz
- High linearity (23 dBm IP_{3out} and 43 dBc IM2)
- 40 dB isolation.

1.3 Applications

- Low Noise Block (LNB) Intermediate Frequency (IF) amplifiers
- Cable systems
- General purpose.

1.4 Quick reference data

Table 1: Quick reference data

Symbol	Parameter	Conditions	Min	Typ	Max	Unit
V_S	DC supply voltage	RF input; AC coupled	-	5	6	V
I_S	DC supply current		23	27.5	33	mA
$ S_{21} ^2$	insertion power gain	$f = 1$ GHz	34.5	35.5	36.2	dB
NF	noise figure	$f = 1$ GHz	-	4.6	4.7	dB
$P_{L(sat)}$	saturated load power	$f = 1$ GHz	13.0	14.0	-	dBm

2. Pinning information

Table 2: Pinning

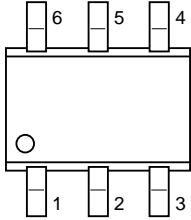
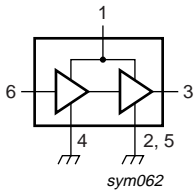
Pin	Description	Simplified outline	Symbol
1	V _S	 <p>SOT363</p>	 <p>sym062</p>
2, 5	GND2		
3	RF_OUT		
4	GND1		
6	RF_IN		

3. Ordering information

Table 3: Ordering information

Type number	Package		
	Name	Description	Version
BGM1013	SC-88	plastic surface mounted package; 6 leads	SOT363

4. Marking

Table 4: Marking codes

Type number	Marking code
BGM1013	C4-

5. Limiting values

Table 5: Limiting values

In accordance with the Absolute Maximum Rating System (IEC 60134).

Symbol	Parameter	Conditions	Min	Max	Unit
V _S	DC supply voltage	RF input; AC coupled	-	6	V
I _S	DC supply current		-	35	mA
P _{tot}	total power dissipation	T _{sp} ≤ 90 °C	-	200	mW
T _{stg}	storage temperature		-65	+150	°C
T _j	junction temperature		-	150	°C
P _D	maximum drive power		-	-10	dBm

6. Recommended operating conditions

Table 6: Operating conditions

Symbol	Parameter	Conditions	Min	Typ	Max	Unit
V_S	supply voltage		4.5	5.0	5.5	V
T_{amb}	ambient temperature		-40	25	85	°C

7. Thermal characteristics

Table 7: Thermal characteristics

Symbol	Parameter	Conditions	Typ	Unit
$R_{th(j-sp)}$	thermal resistance from junction to solder point	$P_{tot} = 200 \text{ mW}$; $T_{sp} \leq 90 \text{ °C}$	300	K/W

8. Characteristics

Table 8: Characteristics

$V_S = 5 \text{ V}$; $I_S = 27.5 \text{ mA}$; $T_j = 25 \text{ °C}$; measured on demo board; unless otherwise specified.

Symbol	Parameter	Conditions	Min	Typ	Max	Unit
V_S	DC supply voltage	RF input; AC coupled	-	5	6	V
I_S	DC supply current		23	27.5	33	mA
$ S_{21} ^2$	insertion power gain	$f = 100 \text{ MHz}$	34.5	35.2	35.9	dB
		$f = 1 \text{ GHz}$	34.5	35.5	36.2	dB
		$f = 1.8 \text{ GHz}$	33.0	34.0	35.2	dB
		$f = 2.2 \text{ GHz}$	30.5	31.8	33.1	dB
		$f = 2.6 \text{ GHz}$	25.2	29.7	31.2	dB
		$f = 3 \text{ GHz}$	24.0	26.1	27.9	dB
$ S_{11} ^2$	input return loss	$f = 1 \text{ GHz}$	10.1	10.6	-	dB
		$f = 2.2 \text{ GHz}$	9.3	10.2	-	dB
$ S_{22} ^2$	output return loss	$Z_L = 50 \text{ } \Omega$				
		$f = 1 \text{ GHz}$	18	20	-	dB
		$f = 2.2 \text{ GHz}$	13	16	-	dB
		$Z_L = 75 \text{ } \Omega$				
		$f = 1 \text{ GHz}$	15	17	-	dB
		$f = 2.2 \text{ GHz}$	12	15	-	dB
$ S_{12} ^2$	isolation	$f = 1 \text{ GHz}$	40	42	-	dB
		$f = 2.2 \text{ GHz}$	34	36	-	dB
NF	noise figure	$f = 1 \text{ GHz}$	-	4.6	4.7	dB
		$f = 2.2 \text{ GHz}$	-	4.9	5.1	dB
B	bandwidth	3 dB below flat gain at $f = 1 \text{ GHz}$	-	2.1	-	GHz
K	stability factor	$f = 1 \text{ GHz}$	1.2	1.3	-	
		$f = 2.2 \text{ GHz}$	0.9	1.0	-	
$P_{L(sat)}$	saturated load power	$f = 1 \text{ GHz}$	13.0	14.0	-	dBm
		$f = 2.2 \text{ GHz}$	9.0	10.2	-	dBm

Table 8: Characteristics ...continued

$V_S = 5\text{ V}$; $I_S = 27.5\text{ mA}$; $T_j = 25\text{ }^\circ\text{C}$; measured on demo board; unless otherwise specified.

Symbol	Parameter	Conditions	Min	Typ	Max	Unit
$P_{L(1dB)}$	load power at 1 dB gain compression	$f = 1\text{ GHz}$	12.0	13.0	-	dBm
		$f = 2.2\text{ GHz}$	7.0	8.1	-	dBm
$IP3_{in}$	input third order intercept point	$f = 1\text{ GHz}$	-14	-12.8	-	dBm
		$f = 2.2\text{ GHz}$	-15	-13.2	-	dBm
$IP3_{out}$	output third order intercept point	$f = 1\text{ GHz}$	21	22.7	-	dBm
		$f = 2.2\text{ GHz}$	17	18.6	-	dBm
IM2	second order intermodulation product	$f_0 = 1\text{ GHz}$; $P_D = -45\text{ dBm}$ ($P_L = -10\text{ dBm}$)	-	45	43	dBc
		$f_0 = 1\text{ GHz}$; $P_D = -40\text{ dBm}$ ($P_L = -5\text{ dBm}$)	-	43	41	dBc

9. Application information

Figure 1 shows a typical application circuit for the BGM1013 MMIC. The device is internally matched to $50\ \Omega$ and therefore does not need any external matching. Output impedance is also very good to $75\ \Omega$ load. The value of the input and output DC blocking capacitors C1 and C2 should be not more than 100 pF for applications above 100 MHz . Their values can be used to fine-tune the input and output impedance.

For the RF-choke, optimal results are obtained with a good quality chip inductor like the TDK MLG1608 (0603) or a wire-wound SMD. The value of the inductor can be used to fine-tune the output impedance.

The RF choke and supply decoupling components should be located as close as possible to the MMIC.

Ground paths must be as short as possible. The printed-circuit board (PCB) top ground plane must be as close as possible to the MMIC, and ideally directly beneath it. When using vias, use at least 3 vias for the top ground plane in order to limit ground path inductance. Supply decoupling with C3 should be from pin 1 to the same top ground plane.

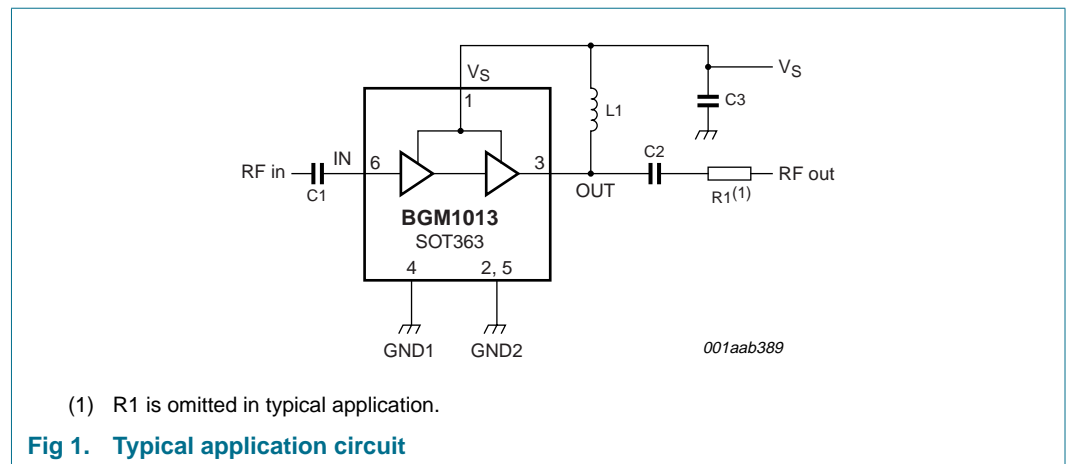

Figure 2 shows the PCB layout used for the typical application.

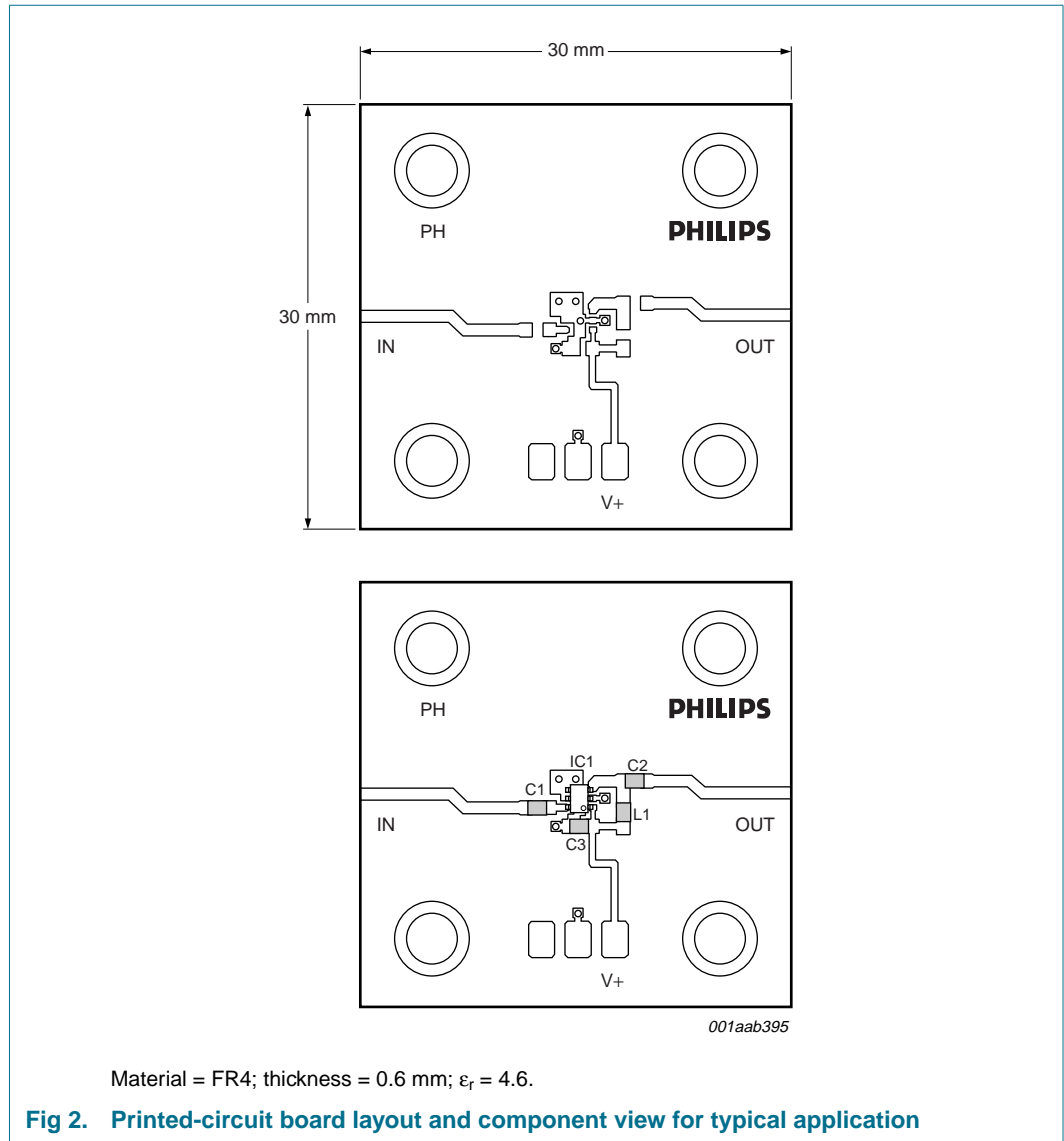

Table 9: List of components used for the typical application

Component	Description	Value	Dimensions
C1, C2	multilayer ceramic chip capacitor	100 pF	0603
C3	multilayer ceramic chip capacitor	22 nF	0603
R1	SMD resistor	-	0603
L1	SMD inductor	100 nH	0603

9.1 Flat gain application: 31 dB between 800 MHz and 2.2 GHz

By changing the components at the output of the amplifier, a flatter gain can be obtained. The gain is 31 dB ± 1 dB between 800 MHz and 2.2 GHz. P_{L(1dB)} is 10 dBm at 1 GHz and 5.7 dBm at 2.2 GHz.

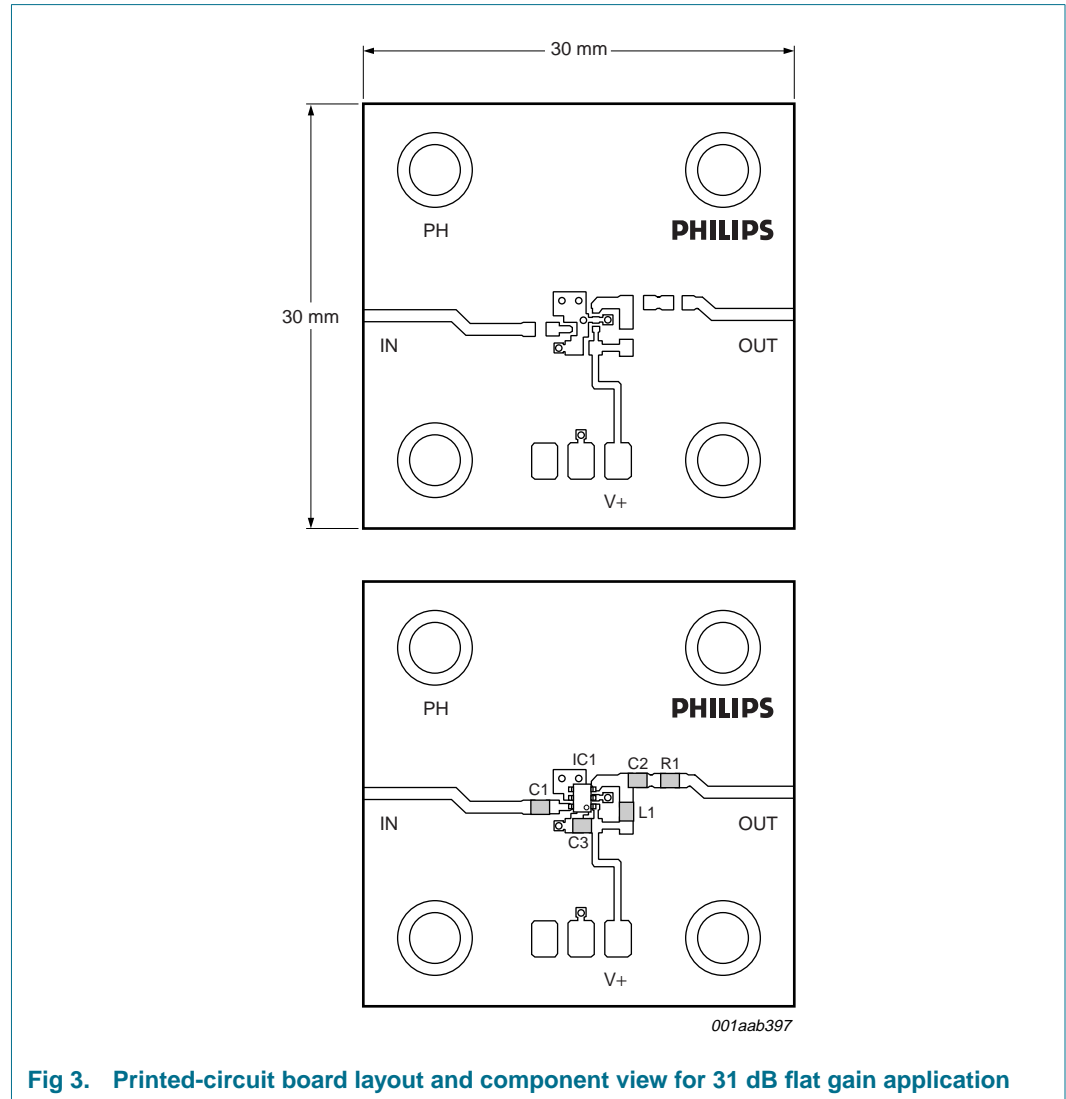
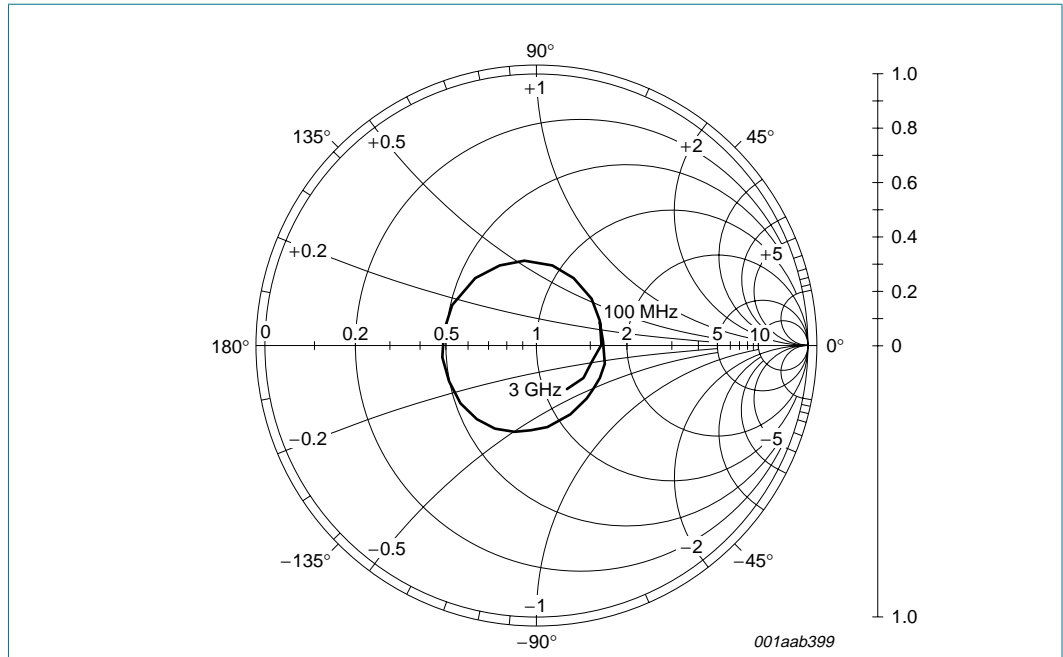

Fig 3. Printed-circuit board layout and component view for 31 dB flat gain application

Table 10: List of components used for the 31 dB flat gain application [1]

Component	Description	Value	Dimensions
C1	multilayer ceramic chip capacitor	100 pF	0603
C2	multilayer ceramic chip capacitor	4.7 nF	0603
C3	multilayer ceramic chip capacitor	22 nF	0603
R1	SMD resistor	27 Ω	0603
L1	SMD inductor	5.6 nH	0603

[1] Pin 2 should not be connected in order to obtain optimal input matching.



$I_S = 27.5 \text{ mA}$; $V_S = 5 \text{ V}$; $P_D = -35 \text{ dBm}$; $Z_o = 50 \Omega$.

Fig 4. Input reflection coefficient (s_{11}); typical values

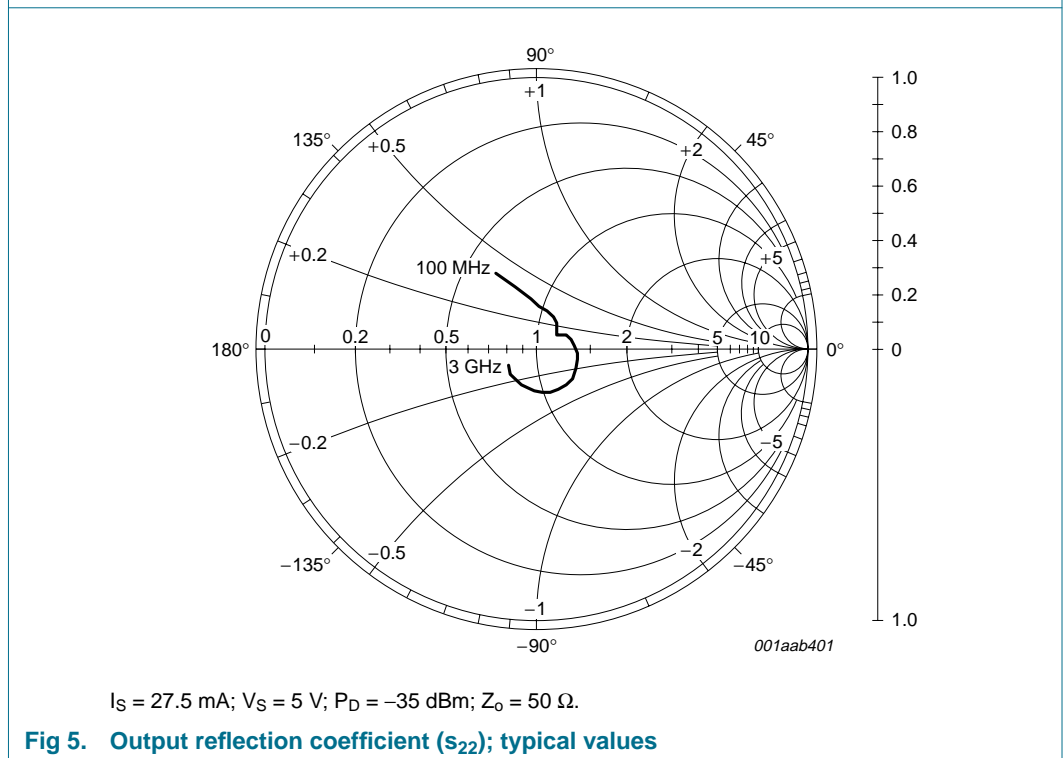

$I_S = 27.5 \text{ mA}$; $V_S = 5 \text{ V}$; $P_D = -35 \text{ dBm}$; $Z_o = 50 \Omega$.

Fig 5. Output reflection coefficient (s_{22}); typical values

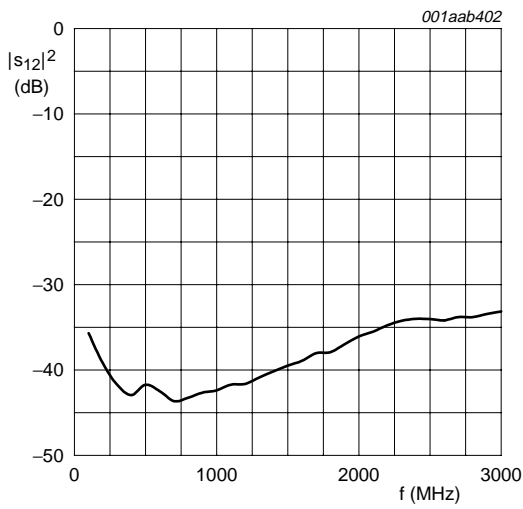

$I_S = 27.5 \text{ mA}$; $V_S = 5 \text{ V}$; $P_D = -35 \text{ dBm}$; $Z_o = 50 \Omega$.

Fig 6. Isolation ($|s_{12}|^2$) as a function of frequency; typical values

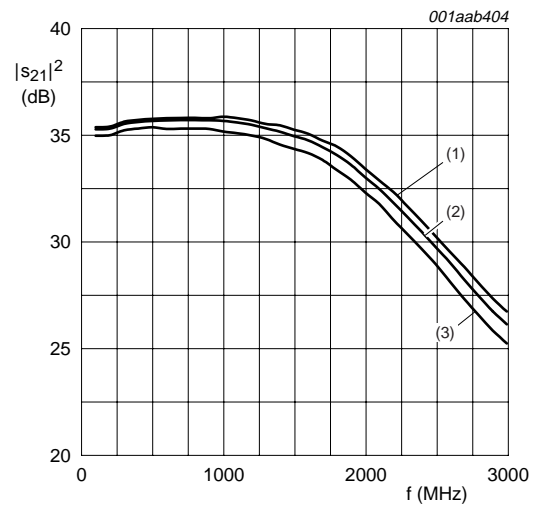

$P_D = -35 \text{ dBm}$; $Z_o = 50 \Omega$.

- (1) $I_S = 32.6 \text{ mA}$; $V_S = 5.5 \text{ V}$.
- (2) $I_S = 27.5 \text{ mA}$; $V_S = 5 \text{ V}$.
- (3) $I_S = 21.5 \text{ mA}$; $V_S = 4.5 \text{ V}$.

Fig 7. Insertion gain ($|s_{21}|^2$) as a function of frequency; typical values

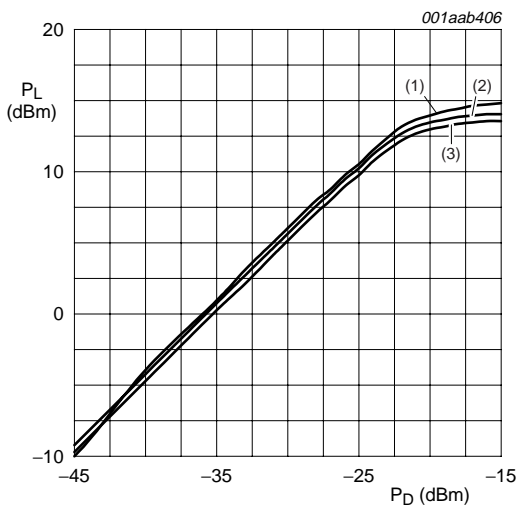

$f = 1 \text{ GHz}$; $Z_o = 50 \Omega$.

- (1) $V_S = 5.5 \text{ V}$.
- (2) $V_S = 5 \text{ V}$.
- (3) $V_S = 4.5 \text{ V}$.

Fig 8. Load power as a function of drive power at 1 GHz; typical values

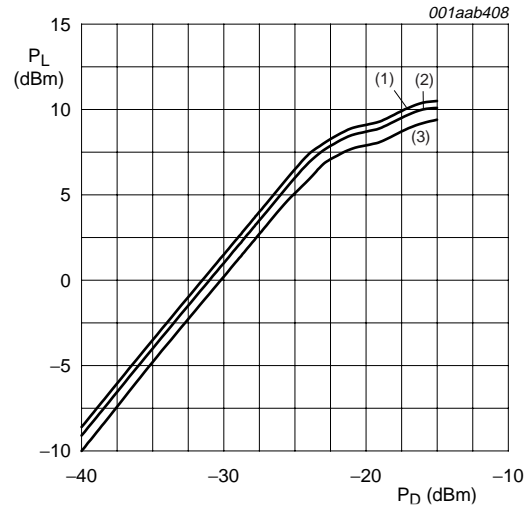

$f = 2.2 \text{ GHz}$; $Z_o = 50 \Omega$.

- (1) $V_S = 5.5 \text{ V}$.
- (2) $V_S = 5 \text{ V}$.
- (3) $V_S = 4.5 \text{ V}$.

Fig 9. Load power as a function of drive power at 2.2 GHz; typical values

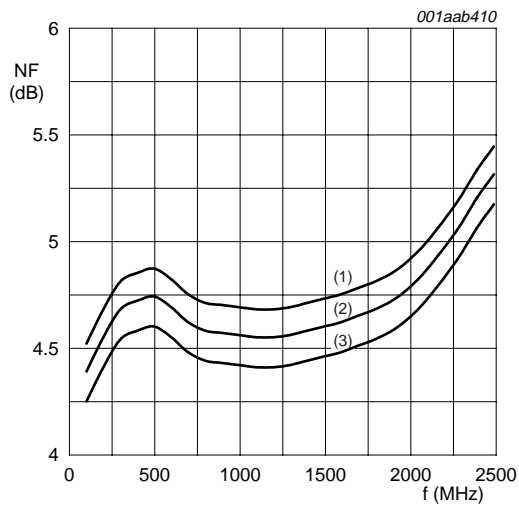

$Z_o = 50 \Omega$.
 (1) $V_S = 5.5$ V.
 (2) $V_S = 5$ V.
 (3) $V_S = 4.5$ V.

Fig 10. Noise figure as a function of frequency; typical values

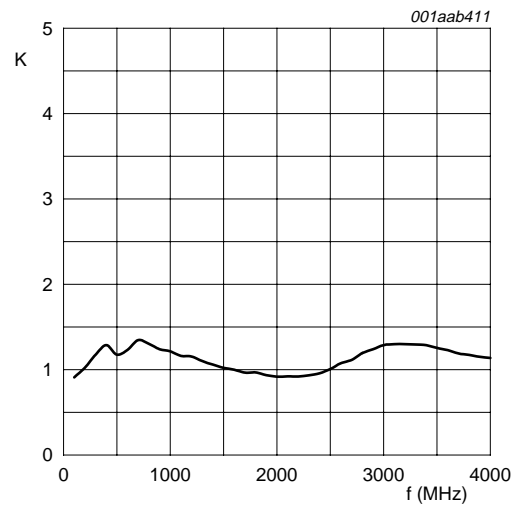

$I_S = 27.5$ mA; $V_S = 5$ V; $Z_o = 50 \Omega$.

Fig 11. Stability factor as a function of frequency; typical values

Table 11: Scattering parameters*V_S = 5 V; I_S = 27.5 mA; P_D = -35 dBm; Z₀ = 50 Ω; T_{amb} = 25 °C; measured on demo board.*

f (MHz)	S ₁₁		S ₂₁		S ₁₂		S ₂₂		K-factor
	Magnitude (ratio)	Angle (deg)	Magnitude (ratio)	Angle (deg)	Magnitude (ratio)	Angle (deg)	Magnitude (ratio)	Angle (deg)	
100	0.259	19.3	57.79	2.5	0.01642	47.3	0.325	118.6	0.9
200	0.258	3.2	57.96	-10.9	0.01096	20.7	0.248	110.9	1.0
400	0.270	-25.6	60.08	-41.2	0.00712	-12.6	0.163	87.0	1.3
600	0.271	-43.7	60.60	-67.0	0.00751	-13.9	0.134	63.2	1.2
800	0.281	-61.5	60.74	-95.6	0.00687	-12.1	0.104	43.7	1.3
1000	0.296	-80.1	60.44	-121.2	0.00759	-7.3	0.092	37.7	1.2
1200	0.317	-102.3	59.21	-147.1	0.00828	-11.5	0.097	33.9	1.2
1400	0.335	-127.7	57.01	-172.9	0.00981	-16.8	0.123	25.6	1.1
1600	0.334	-158.1	54.46	160.8	0.01130	-25.1	0.142	6.0	1.0
1800	0.331	169.6	50.31	134.1	0.01272	-34.0	0.157	-14.2	1.0
2000	0.326	130.6	44.63	104.7	0.01571	-43.0	0.172	-39.8	0.9
2200	0.309	95.9	38.92	79.4	0.01826	-57.0	0.172	-61.9	0.9
2400	0.287	59.0	33.31	55.5	0.01994	-69.2	0.161	-83.5	1.0
2600	0.257	20.4	28.20	33.1	0.01952	-78.3	0.147	-104.4	1.1
2800	0.224	-15.5	23.60	13.1	0.02037	-89.9	0.139	-125.1	1.2
3000	0.198	-50.7	20.24	-4.8	0.02198	-99.8	0.127	-151.5	1.3

10. Package outline

Plastic surface mounted package; 6 leads

SOT363

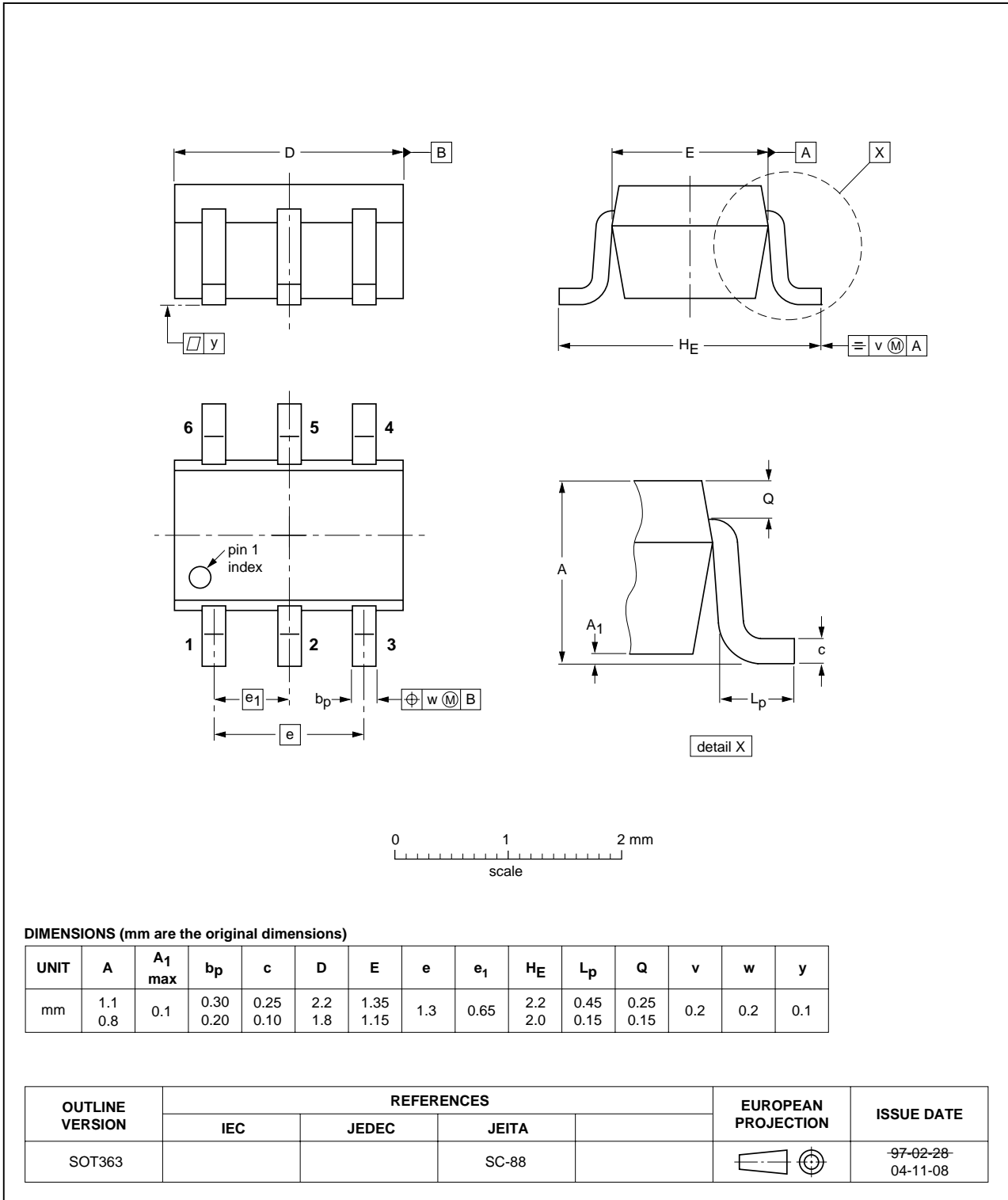

Fig 12. Package outline SOT363 (SC-88)

11. Revision history

Table 12: Revision history

Document ID	Release date	Data sheet status	Change notice	Doc. number	Supersedes
BGM1013_3	20041209	Product data sheet	-	9397 750 14413	BGM1013_2
Modifications:	• Section 6 added.				
BGM1013_2	20041130	Product data sheet	-	9397 750 14229	BGM1013_1
BGM1013_1	20040831	Product data sheet	-	9397 750 13469	-

12. Data sheet status

Level	Data sheet status ^[1]	Product status ^[2] ^[3]	Definition
I	Objective data	Development	This data sheet contains data from the objective specification for product development. Philips Semiconductors reserves the right to change the specification in any manner without notice.
II	Preliminary data	Qualification	This data sheet contains data from the preliminary specification. Supplementary data will be published at a later date. Philips Semiconductors reserves the right to change the specification without notice, in order to improve the design and supply the best possible product.
III	Product data	Production	This data sheet contains data from the product specification. Philips Semiconductors reserves the right to make changes at any time in order to improve the design, manufacturing and supply. Relevant changes will be communicated via a Customer Product/Process Change Notification (CPCN).

[1] Please consult the most recently issued data sheet before initiating or completing a design.

[2] The product status of the device(s) described in this data sheet may have changed since this data sheet was published. The latest information is available on the Internet at URL <http://www.semiconductors.philips.com>.

[3] For data sheets describing multiple type numbers, the highest-level product status determines the data sheet status.

13. Definitions

Short-form specification — The data in a short-form specification is extracted from a full data sheet with the same type number and title. For detailed information see the relevant data sheet or data handbook.

Limiting values definition — Limiting values given are in accordance with the Absolute Maximum Rating System (IEC 60134). Stress above one or more of the limiting values may cause permanent damage to the device. These are stress ratings only and operation of the device at these or at any other conditions above those given in the Characteristics sections of the specification is not implied. Exposure to limiting values for extended periods may affect device reliability.

Application information — Applications that are described herein for any of these products are for illustrative purposes only. Philips Semiconductors make no representation or warranty that such applications will be suitable for the specified use without further testing or modification.

14. Disclaimers

Life support — These products are not designed for use in life support appliances, devices, or systems where malfunction of these products can reasonably be expected to result in personal injury. Philips Semiconductors customers using or selling these products for use in such applications do so at their own risk and agree to fully indemnify Philips Semiconductors for any damages resulting from such application.

Right to make changes — Philips Semiconductors reserves the right to make changes in the products - including circuits, standard cells, and/or software - described or contained herein in order to improve design and/or performance. When the product is in full production (status 'Production'), relevant changes will be communicated via a Customer Product/Process Change Notification (CPCN). Philips Semiconductors assumes no responsibility or liability for the use of any of these products, conveys no license or title under any patent, copyright, or mask work right to these products, and makes no representations or warranties that these products are free from patent, copyright, or mask work right infringement, unless otherwise specified.

15. Contact information

For additional information, please visit: <http://www.semiconductors.philips.com>

For sales office addresses, send an email to: sales.addresses@www.semiconductors.philips.com

16. Contents

1	Product profile	1
1.1	General description	1
1.2	Features	1
1.3	Applications	1
1.4	Quick reference data	1
2	Pinning information	2
3	Ordering information	2
4	Marking	2
5	Limiting values	2
6	Recommended operating conditions	3
7	Thermal characteristics	3
8	Characteristics	3
9	Application information	4
9.1	Flat gain application: 31 dB between 800 MHz and 2.2 GHz	6
10	Package outline	11
11	Revision history	12
12	Data sheet status	13
13	Definitions	13
14	Disclaimers	13
15	Contact information	13



© Koninklijke Philips Electronics N.V. 2004

All rights are reserved. Reproduction in whole or in part is prohibited without the prior written consent of the copyright owner. The information presented in this document does not form part of any quotation or contract, is believed to be accurate and reliable and may be changed without notice. No liability will be accepted by the publisher for any consequence of its use. Publication thereof does not convey nor imply any license under patent- or other industrial or intellectual property rights.

Date of release: 9 December 2004
Document number: 9397 750 14413

Published in The Netherlands