

DATA SHEET

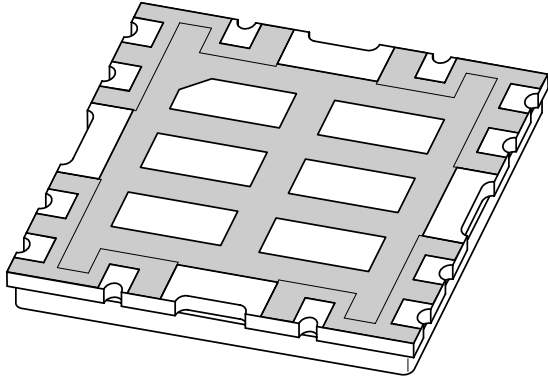

BGY280 UHF amplifier module

Preliminary specification

2000 Nov 15

UHF amplifier module

BGY280

FEATURES

- Dual band GSM amplifier
- 3.6 V nominal supply voltage
- 33.5 dBm output power for GSM1800
- 35.5 dBm output power for GSM900
- Easy output power control by DC voltage.
- Internal input and output matching.

APPLICATIONS

- Digital cellular radio systems with Time Division Multiple Access (TDMA) operation (GSM systems) in two frequency bands: 880 to 915 MHz and 1710 to 1785 MHz.

DESCRIPTION

The BGY280 is a power amplifier module in a SOT559A leadless package with a plastic cap. The dimensions are 13.75 x 11 x 1.7 mm. The module consists of two separated line-ups. One for GSM900 and one for GSM1800. Internal power control, input and output matching.

PINNING - SOT559A

PIN	DESCRIPTION
1,2,3,6,9,10,11,14	Ground
4	RF output 2 (1800 MHz)
5	V _{S2} (1800 MHz)
7	V _{S1} (900 MHz)
8	RF output 1 (900 MHz)
12	RF input 1 (900 MHz)
13	V _{C1} (900 MHz)
15	V _{C2} (1800 MHz)
16	RF input 2 (1800 MHz)

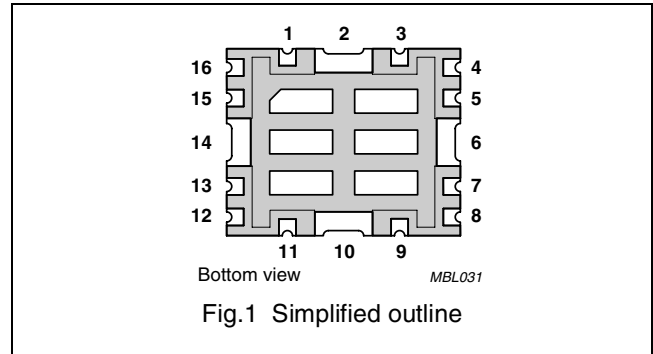

QUICK REFERENCE DATA

RF performance at T_{mb} = 25 °C.

MODE OF OPERATION	f (MHz)	V _S (V)	V _C (V)	P _L (dBm)	G _p (dB)	η (%)	Z _S , Z _L (Ω)
Pulsed; δ = 2 : 8	880 to 915	3.6	≤2.2	typ. 35.5	typ. 35.5	47	50
	1710 to 1785	3.6	≤2.2	typ. 33.5	typ. 33.5	40	50

LIMITING VALUES

In accordance with the Absolute Maximum Rating System (IEC 134).

SYMBOL	PARAMETER	CONDITIONS	MIN.	MAX.	UNIT
V _{S1} , V _{S2}	DC supply voltage	V _{C1,2} = 0; RF _{IN} = off	–	7	V
		V _{C1,2} > 0.5 V; RF _{IN} = on	–	5.5	V
V _{C1} , V _{C2}	DC control voltage		–	3	V
P _{D1} , P _{D2}	input drive power		–	10	mW
P _{L1}	load power 1		–	4	W
P _{L2}	load power 2		–	3	W
T _{stg}	storage temperature		–40	+100	°C
T _{mb}	operating mounting base temperature		–30	+100	°C

UHF amplifier module

BGY280

CHARACTERISTICS

$Z_S = Z_L = 50 \Omega$; $P_{D1,2} = 0 \text{ dBm}$; $V_{S1} = V_{S2} = 3.6 \text{ V}$; $V_{C1,2} \leq 2.2 \text{ V}$; $T_{mb} = 25 \text{ }^\circ\text{C}$; $t_p = 575 \text{ } \mu\text{s}$; $\delta = 2 : 8$;
 $f = 880 \text{ to } 915 \text{ MHz (GSM900)}$; $f = 1710 \text{ to } 1785 \text{ MHz (GSM1800)}$; unless otherwise specified.

SYMBOL	PARAMETER	CONDITIONS	MIN.	TYP.	MAX.	UNIT
I_L	leakage current	$V_{C1,2} = 0.2 \text{ V}$	–	–	10	μA
I_{CM1}, I_{CM2}	peak control current		–	–	2	mA
P_{L1}	load power GSM 900	$V_{C1} = 2.2 \text{ V}$	34.5	35.5	–	dBm
		$V_{C1} = 2.2 \text{ V}$; $V_{S1} = 3.2 \text{ V}$; $T_{mb} = 25 \text{ }^\circ\text{C}$	34	35	–	dBm
P_{L2}	load power GSM 1800	$V_{C2} = 2.2 \text{ V}$	32.5	33.5	–	dBm
		$V_{C2} = 2.2 \text{ V}$; $V_{S1} = 3.2 \text{ V}$; $T_{mb} = 25 \text{ }^\circ\text{C}$	32	33	–	dBm
G_{P1}	power gain GSM900	$P_{L1} = 35.5 \text{ dBm}$	–	35.5	–	dB
G_{P2}	power gain GSM1800	$P_{L2} = 33 \text{ dBm}$	–	33.5	–	dB
η_1	efficiency GSM900	$P_{L1} = 35 \text{ dBm}$	40	45	–	%
η_2	efficiency GSM1800	$P_{L2} = 32 \text{ dBm}$	33	38	–	%
H_2, H_3	harmonics GSM900	$P_{L1} = 34 \text{ dBm}$	–	–	–40	dBc
	harmonics GSM1800	$P_{L2} = 32 \text{ dBm}$	–	–	–35	dBc
$VSWR_{in}$	input VSWR of active device	$V_{S1,2} = 3.2 \text{ to } 5 \text{ V}$; $P_{L1} = 34 \text{ dBm}$; $P_{L2} = 32 \text{ dBm}$	–	–	3 : 1	
	input VSWR of inactive device	$V_{S1,2} = 3.2 \text{ to } 5 \text{ V}$; $V_{C1,2} \leq 0.5 \text{ V}$	–	–	8 : 1	
	isolation GSM900	$V_{C1,2} = 0.5 \text{ V}$; $P_{D1,2} = 3 \text{ dBm}$	–	–54	–37	dBm
	isolation GSM1800	$V_{C1,2} = 0.5 \text{ V}$; $P_{D1,2} = 3 \text{ dBm}$	–	–42	–37	dBm
	second harmonic isolation from GSM900 into GSM1800	$P_{L1} = 35 \text{ dBm}$	–	–21	–20	dBm
	maximum slope	$-5 \text{ dBm} < P_{L1,2} < P_{L \text{ max}}$	120	–	200	dB/V
t_r	carrier rise time	$P_{L1} = 6 \text{ to } 34 \text{ dBm}$; $P_{L2} = 4 \text{ to } 32 \text{ dBm}$; time to settle within -0.5 dB of final P_L	–	1.5	2	μs
t_f	carrier fall time	$P_{L1} = 6 \text{ to } 34 \text{ dBm}$; $P_{L2} = 4 \text{ to } 32 \text{ dBm}$; time to fall below -37 dBm	–	1.5	2	μs
P_n	noise power GSM900	$P_{L1} \leq 34 \text{ dBm}$; bandwidth = 100 kHz; $f = 925 - 935 \text{ MHz}$; $f_c = 897.5 \text{ MHz}$	–	–	–71	dBm
		$P_{L1} \leq 34 \text{ dBm}$; bandwidth = 100 kHz; $f = 935 - 960 \text{ MHz}$; $f_c = 897.5 \text{ MHz}$	–	–82	–80	dBm
	noise power GSM1800	$P_{L2} \leq 32 \text{ dBm}$; bandwidth = 100 kHz; $f = 1805 - 1880 \text{ MHz}$; $f_c = 1747.5 \text{ MHz}$	–	–80	–73	dBm
	AM/PM conversion	$P_{D1,2} = -0.5 \text{ to } 0.5 \text{ dBm}$; $P_{L1,2} = \text{constant during measurement}$ for $P_{L1} = 6 \text{ to } 34 \text{ dBm}$ and $P_{L2} = 4 \text{ to } 32 \text{ dBm}$	–	–	6	deg/dB
	AM/AM conversion	$P_{L1} = 6 \text{ to } 34 \text{ dBm}$; $P_{L2} = 4 \text{ to } 32 \text{ dBm}$; $f = 100 \text{ kHz}$; $P_{D1,2} = 5.4 \text{ } \%$	–	–	25	%

UHF amplifier module

BGY280

SYMBOL	PARAMETER	CONDITIONS	MIN.	TYP.	MAX.	UNIT
	T_X / R_X conversion	$P_{L1} = 34 \text{ dBm}; f = 915 \text{ MHz}$ $P_{L1} (925 \text{ MHz}) / P_D (905 \text{ MHz})$ $P_{L2} = 32 \text{ dBm}; f = 1785 \text{ MHz}$ $P_{L2} (1765 \text{ MHz}) / P_D (1805 \text{ MHz})$	–	25	–	dB
	control bandwidth	$P_{L1} = 6 \text{ to } 34 \text{ dBm}; P_{L2} = 4 \text{ to } 32 \text{ dBm};$	1	1.5	–	MHz
	stability	$V_{S1,2} = 3.2 \text{ to } 5 \text{ V}; V_C = 0 \text{ to } 2.2 \text{ V};$ $P_{D1,2} = 0 \text{ to } 3 \text{ dBm}; P_{L1} < 34.8 \text{ dBm};$ $P_{L2} < 32.5 \text{ dBm};$ $VSWR \leq 6 : 1$ through all phases	–	–	–60	dBc
	ruggedness	$V_{S1,2} = 5 \text{ V}; P_{D1,2} = 0 \text{ to } 3 \text{ dBm};$ $P_{L1} = 34.8 \text{ dBm}; P_{L2} = 32.5 \text{ dBm};$ $VSWR \leq 6 : 1$ through all phases	no degradation			
		$V_{S1,2} = 4.2 \text{ V}; P_{D1,2} = 0 \text{ to } 3 \text{ dBm};$ $P_{L1} = 34.8 \text{ dBm}; P_{L2} = 32.5 \text{ dBm};$ $VSWR \leq 10 : 1$ through all phases	no degradation			

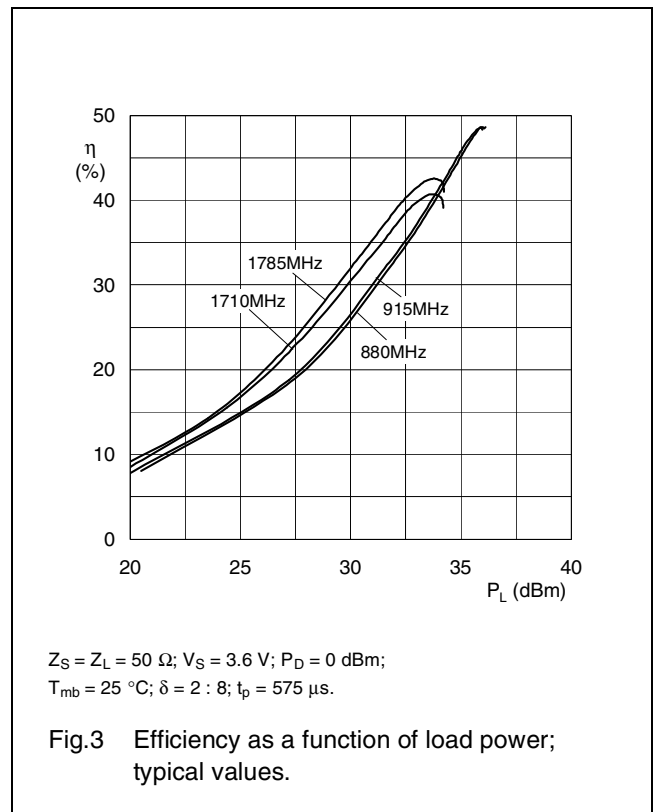
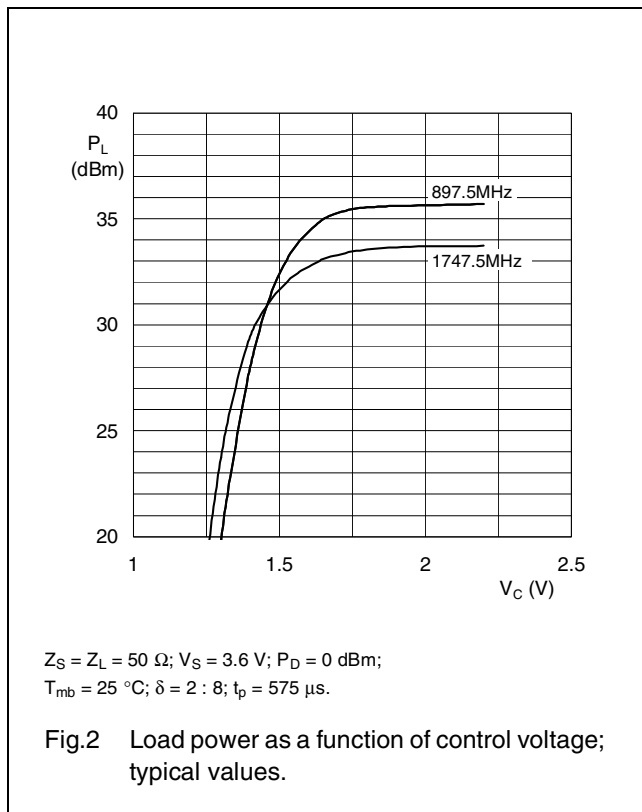

UHF amplifier module

BGY280

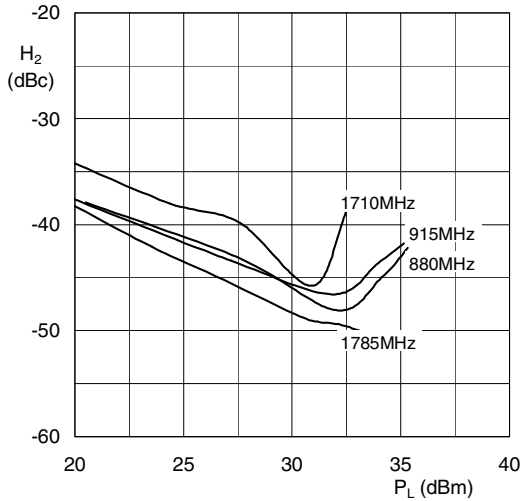

$Z_S = Z_L = 50 \Omega$; $V_S = 3.6 \text{ V}$; $P_D = 0 \text{ dBm}$;
 $T_{mb} = 25 \text{ }^\circ\text{C}$; $\delta = 2 : 8$; $t_p = 575 \mu\text{s}$.

Fig.4 Second harmonic as a function of load power; typical values.

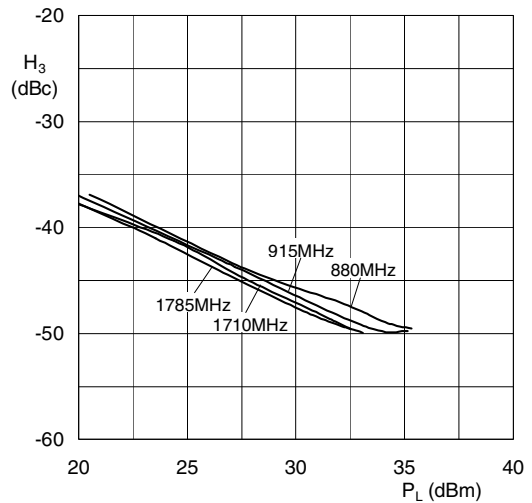

$Z_S = Z_L = 50 \Omega$; $V_S = 3.6 \text{ V}$; $P_D = 0 \text{ dBm}$;
 $T_{mb} = 25 \text{ }^\circ\text{C}$; $\delta = 2 : 8$; $t_p = 575 \mu\text{s}$.

Fig.5 Third harmonic as a function of load power; typical values.

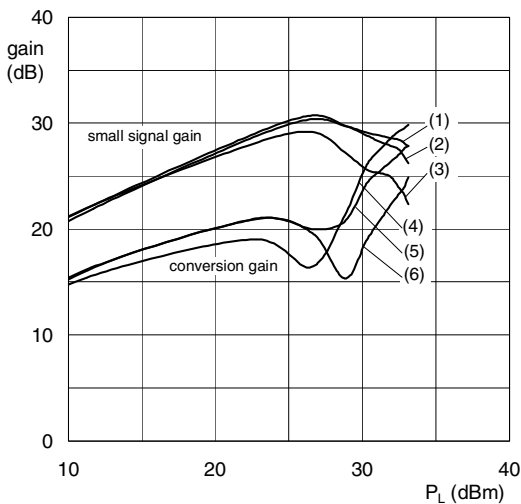

$Z_S = Z_L = 50 \Omega$; $P_D = 0 \text{ dBm}$; $V_S = 3.6 \text{ V}$; $T_{mb} = 25 \text{ }^\circ\text{C}$;
 $f_c = 1747.5 \text{ MHz}$; $\delta = 2 : 8$; $t_p = 575 \mu\text{s}$.

- (1) $f = 1805 \text{ MHz}$ (4) $f = 1615 \text{ MHz}$
- (2) $f = 1842.5 \text{ MHz}$ (5) $f = 1625.5 \text{ MHz}$
- (3) $f = 1880 \text{ MHz}$ (6) $f = 1690 \text{ MHz}$

Fig.6 Gain as a function of load power; typical values.

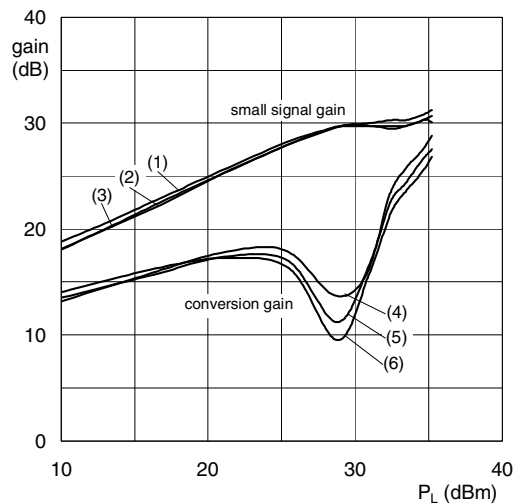

$Z_S = Z_L = 50 \Omega$; $V_S = 3.6 \text{ V}$; $P_D = 0 \text{ dBm}$;
 $T_{mb} = 25 \text{ }^\circ\text{C}$; $f_c = 897.5 \text{ MHz}$; $\delta = 2 : 8$; $t_p = 575 \mu\text{s}$.

- (1) $f = 925 \text{ MHz}$ (4) $f = 835 \text{ MHz}$
- (2) $f = 942.5 \text{ MHz}$ (5) $f = 852.5 \text{ MHz}$
- (3) $f = 960 \text{ MHz}$ (6) $f = 870 \text{ MHz}$

Fig.7 Gain as a function of load power; typical values.

UHF amplifier module

BGY280

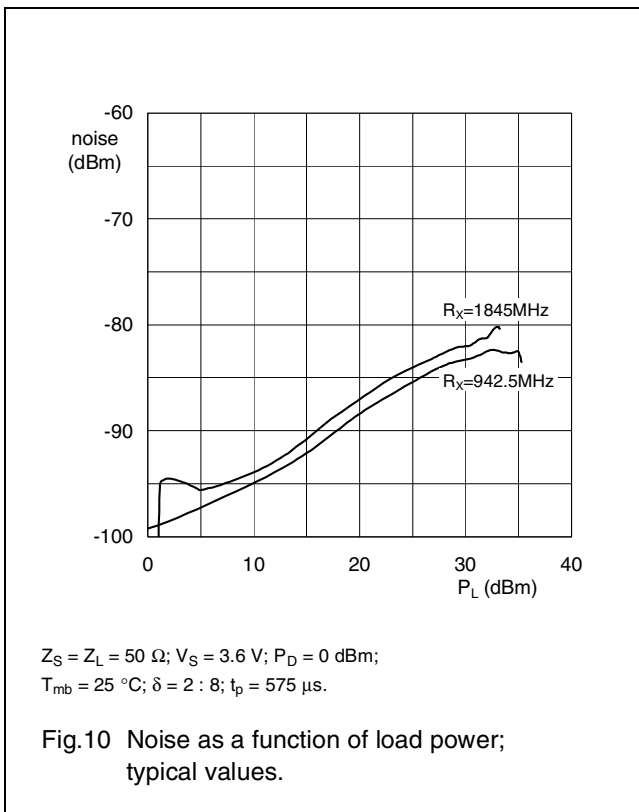
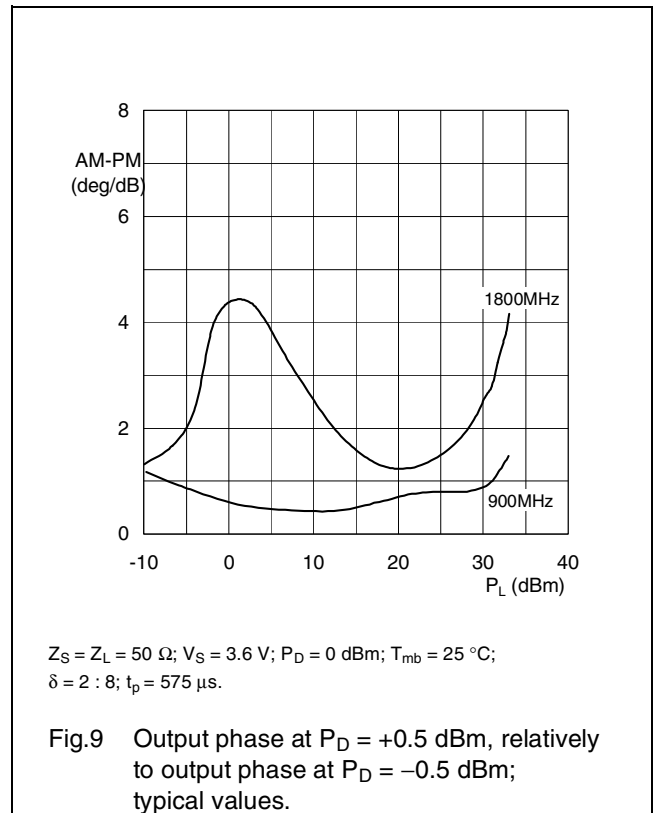
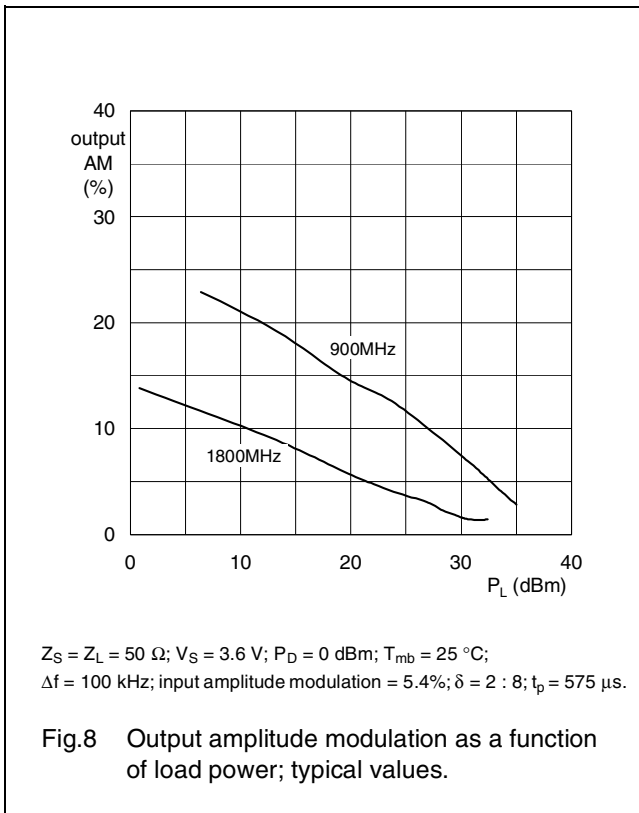

UHF amplifier module

BGY280

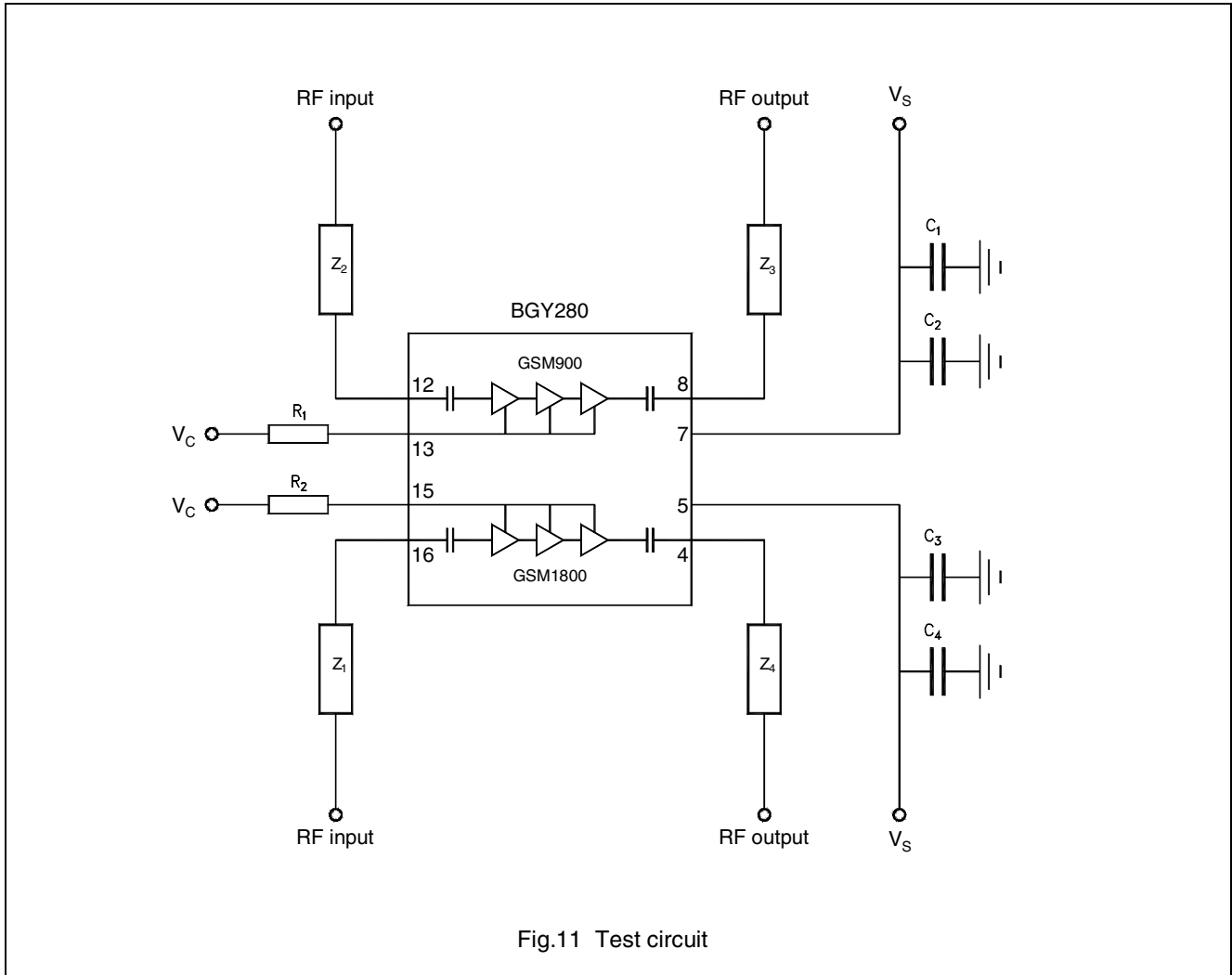

Fig.11 Test circuit

List of components (See Fig 10 and 11)

COMPONENT	DESCRIPTION	VALUE	DIMENSIONS	CATALOGUE NO.
C ₁ , C ₄	multilayer ceramic chip capacitor	100 μF; 40 V		
C ₂ , C ₃	electrolytic capacitor	100 nF		
Z ₁ , Z ₂ , Z ₃ , Z ₄	stripline; note 1	50 Ω	width 2.33 mm	
R ₁ , R ₂	metal film resistor	100 Ω; 0.6 W		2322 156 11001

Note

1. The striplines are on a double copper-clad printed-circuit board with PTFE fibreglass dielectric ($\epsilon_r = 2.2$); thickness $\frac{1}{32}$ inch.

UHF amplifier module

BGY280

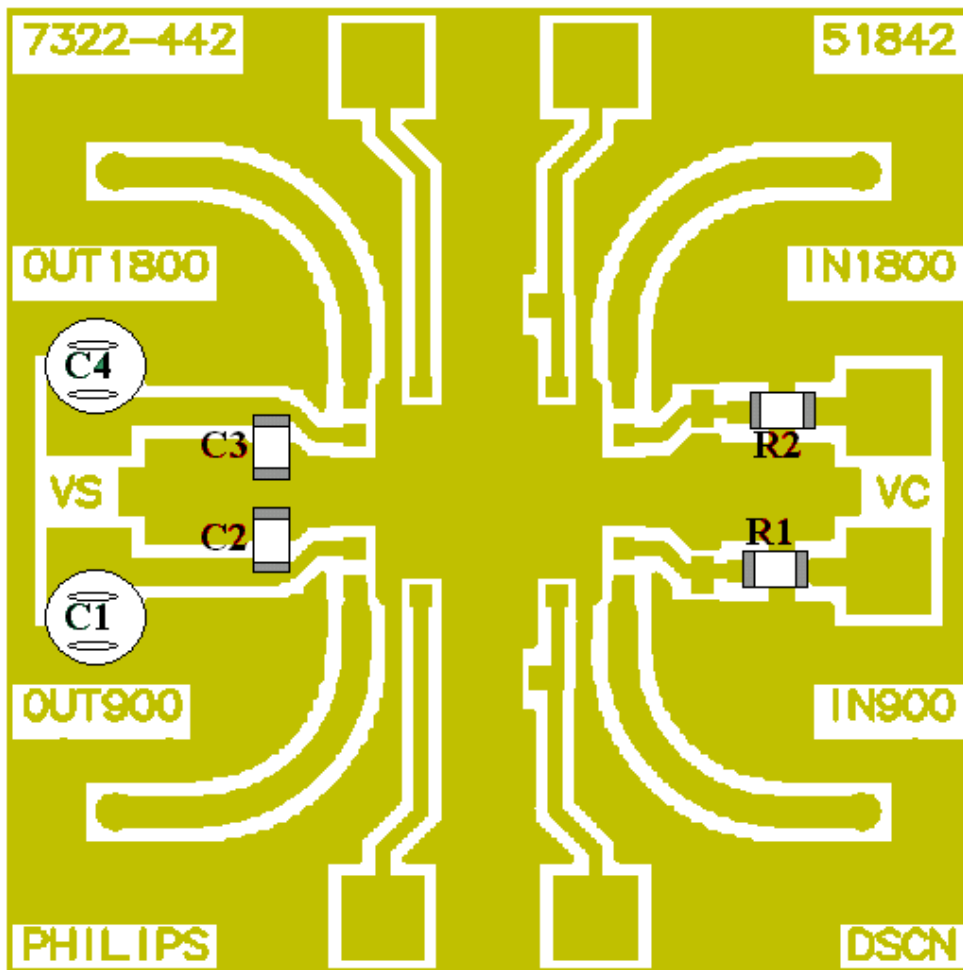

Fig.12 PCB testcircuit

UHF amplifier module

BGY280

PACKAGE OUTLINE SOT559A

Leadless surface mounted package; plastic cap; 16 terminations

SOT559A

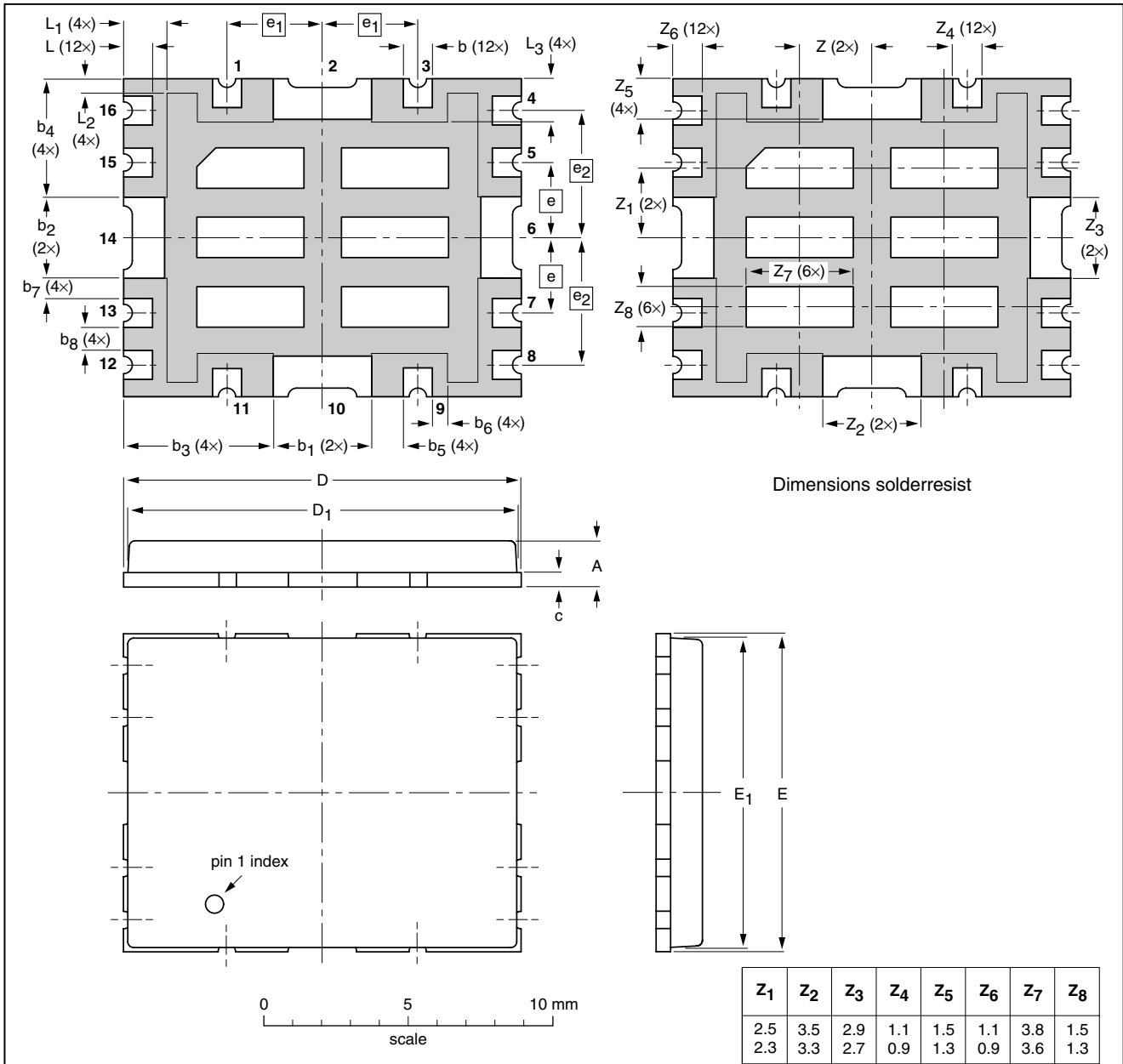

Z ₁	Z ₂	Z ₃	Z ₄	Z ₅	Z ₆	Z ₇	Z ₈
2.5	3.5	2.9	1.1	1.5	1.1	3.8	1.5
2.3	3.3	2.7	0.9	1.3	0.9	3.6	1.3

DIMENSIONS (mm are the original dimensions)

UNIT	A	b	b ₁	b ₂	b ₃	b ₄	b ₅	b ₆	b ₇	b ₈	c	D	D ₁	E	E ₁	e	e ₁	e ₂	L	L ₁	L ₂	L ₃	Z
mm	1.9	1.1	3.5	2.9	5.275	4.2	1.2	0.625	0.8	0.9	0.55	14.05	13.6	11.3	10.85	2.6	3.3	4.4	1.1	1.6	0.6	1.6	2.6
	1.5	0.9	3.3	2.7	5.075	4.0	1.0	0.425	0.6	0.7	0.45	13.45	13.3	10.7	10.55				0.9	1.4	0.4	1.4	2.4

OUTLINE VERSION	REFERENCES				EUROPEAN PROJECTION	ISSUE DATE
	IEC	JEDEC	EIAJ			
SOT559A						00-01-31 00-09-28

UHF amplifier module

BGY280

DATA SHEET STATUS

DATA SHEET STATUS	PRODUCT STATUS	DEFINITIONS ⁽¹⁾
Objective specification	Development	This data sheet contains the design target or goal specifications for product development. Specification may change in any manner without notice.
Preliminary specification	Qualification	This data sheet contains preliminary data, and supplementary data will be published at a later date. Philips Semiconductors reserves the right to make changes at any time without notice in order to improve design and supply the best possible product.
Product specification	Production	This data sheet contains final specifications. Philips Semiconductors reserves the right to make changes at any time without notice in order to improve design and supply the best possible product.

Note

1. Please consult the most recently issued data sheet before initiating or completing a design.

DEFINITIONS

Short-form specification — The data in a short-form specification is extracted from a full data sheet with the same type number and title. For detailed information see the relevant data sheet or data handbook.

Limiting values definition — Limiting values given are in accordance with the Absolute Maximum Rating System (IEC 60134). Stress above one or more of the limiting values may cause permanent damage to the device.

These are stress ratings only and operation of the device at these or at any other conditions above those given in the Characteristics sections of the specification is not implied. Exposure to limiting values for extended periods may affect device reliability.

Application information — Applications that are described herein for any of these products are for illustrative purposes only. Philips Semiconductors make no representation or warranty that such applications will be suitable for the specified use without further testing or modification.

DISCLAIMERS

Life support applications — These products are not designed for use in life support appliances, devices, or systems where malfunction of these products can reasonably be expected to result in personal injury. Philips Semiconductors customers using or selling these products for use in such applications do so at their own risk and agree to fully indemnify Philips Semiconductors for any damages resulting from such application.

Right to make changes — Philips Semiconductors reserves the right to make changes, without notice, in the products, including circuits, standard cells, and/or software, described or contained herein in order to improve design and/or performance. Philips Semiconductors assumes no responsibility or liability for the use of any of these products, conveys no licence or title under any patent, copyright, or mask work right to these products, and makes no representations or warranties that these products are free from patent, copyright, or mask work right infringement, unless otherwise specified.

Philips Semiconductors – a worldwide company

Argentina: see South America

Australia: 3 Figtree Drive, HOMEBUSH, NSW 2140,
Tel. +61 2 9704 8141, Fax. +61 2 9704 8139

Austria: Computerstr. 6, A-1101 WIEN, P.O. Box 213,
Tel. +43 1 60 101 1248, Fax. +43 1 60 101 1210

Belarus: Hotel Minsk Business Center, Bld. 3, r. 1211, Volodarski Str. 6,
220050 MINSK, Tel. +375 172 20 0733, Fax. +375 172 20 0773

Belgium: see The Netherlands

Brazil: see South America

Bulgaria: Philips Bulgaria Ltd., Energoproject, 15th floor,
51 James Bourchier Blvd., 1407 SOFIA,
Tel. +359 2 68 9211, Fax. +359 2 68 9102

Canada: PHILIPS SEMICONDUCTORS/COMPONENTS,
Tel. +1 800 234 7381, Fax. +1 800 943 0087

China/Hong Kong: 501 Hong Kong Industrial Technology Centre,
72 Tat Chee Avenue, Kowloon Tong, HONG KONG,
Tel. +852 2319 7888, Fax. +852 2319 7700

Colombia: see South America

Czech Republic: see Austria

Denmark: Sydhavnsgade 23, 1780 COPENHAGEN V,
Tel. +45 33 29 3333, Fax. +45 33 29 3905

Finland: Sinikalliontie 3, FIN-02630 ESPOO,
Tel. +358 9 615 800, Fax. +358 9 6158 0920

France: 51 Rue Carnot, BP317, 92156 SURESNES Cedex,
Tel. +33 1 4099 6161, Fax. +33 1 4099 6427

Germany: Hammerbrookstraße 69, D-20097 HAMBURG,
Tel. +49 40 2353 60, Fax. +49 40 2353 6300

Hungary: see Austria

India: Philips INDIA Ltd, Band Box Building, 2nd floor,
254-D, Dr. Annie Besant Road, Worli, MUMBAI 400 025,
Tel. +91 22 493 8541, Fax. +91 22 493 0966

Indonesia: PT Philips Development Corporation, Semiconductors Division,
Gedung Philips, Jl. Buncit Raya Kav.99-100, JAKARTA 12510,
Tel. +62 21 794 0040 ext. 2501, Fax. +62 21 794 0080

Ireland: Newstead, Clonskeagh, DUBLIN 14,
Tel. +353 1 7640 000, Fax. +353 1 7640 200

Israel: RAPAC Electronics, 7 Kehilat Saloniki St, PO Box 18053,
TEL AVIV 61180, Tel. +972 3 645 0444, Fax. +972 3 649 1007

Italy: PHILIPS SEMICONDUCTORS, Via Casati, 23 - 20052 MONZA (MI),
Tel. +39 039 203 6838, Fax +39 039 203 6800

Japan: Philips Bldg 13-37, Kohnan 2-chome, Minato-ku,
TOKYO 108-8507, Tel. +81 3 3740 5130, Fax. +81 3 3740 5057

Korea: Philips House, 260-199 Itaewon-dong, Yongsan-ku, SEOUL,
Tel. +82 2 709 1412, Fax. +82 2 709 1415

Malaysia: No. 76 Jalan Universiti, 46200 PETALING JAYA, SELANGOR,
Tel. +60 3 750 5214, Fax. +60 3 757 4880

Mexico: 5900 Gateway East, Suite 200, EL PASO, TEXAS 79905,
Tel. +9-5 800 234 7381, Fax +9-5 800 943 0087

Middle East: see Italy

Netherlands: Postbus 90050, 5600 PB EINDHOVEN, Bldg. VB,
Tel. +31 40 27 82785, Fax. +31 40 27 88399

New Zealand: 2 Wagener Place, C.P.O. Box 1041, AUCKLAND,
Tel. +64 9 849 4160, Fax. +64 9 849 7811

Norway: Box 1, Manglerud 0612, OSLO,
Tel. +47 22 74 8000, Fax. +47 22 74 8341

Pakistan: see Singapore

Philippines: Philips Semiconductors Philippines Inc.,
106 Valero St. Salcedo Village, P.O. Box 2108 MCC, MAKATI,
Metro MANILA, Tel. +63 2 816 6380, Fax. +63 2 817 3474

Poland: Al.Jerozolimskie 195 B, 02-222 WARSAW,
Tel. +48 22 5710 000, Fax. +48 22 5710 001

Portugal: see Spain

Romania: see Italy

Russia: Philips Russia, Ul. Usatcheva 35A, 119048 MOSCOW,
Tel. +7 095 755 6918, Fax. +7 095 755 6919

Singapore: Lorong 1, Toa Payoh, SINGAPORE 319762,
Tel. +65 350 2538, Fax. +65 251 6500

Slovakia: see Austria

Slovenia: see Italy

South Africa: S.A. PHILIPS Pty Ltd., 195-215 Main Road Martindale,
2092 JOHANNESBURG, P.O. Box 58088 Newville 2114,
Tel. +27 11 471 5401, Fax. +27 11 471 5398

South America: Al. Vicente Pinzon, 173, 6th floor,
04547-130 SÃO PAULO, SP, Brazil,
Tel. +55 11 821 2333, Fax. +55 11 821 2382

Spain: Balmes 22, 08007 BARCELONA,
Tel. +34 93 301 6312, Fax. +34 93 301 4107

Sweden: Kottbygatan 7, Akalla, S-16485 STOCKHOLM,
Tel. +46 8 5985 2000, Fax. +46 8 5985 2745

Switzerland: Allmendstrasse 140, CH-8027 ZÜRICH,
Tel. +41 1 488 2741 Fax. +41 1 488 3263

Taiwan: Philips Semiconductors, 5F, No. 96, Chien Kuo N. Rd., Sec. 1,
TAIPEI, Taiwan Tel. +886 2 2134 2451, Fax. +886 2 2134 2874

Thailand: PHILIPS ELECTRONICS (THAILAND) Ltd.,
60/14 MOO 11, Bangna Trad Road KM. 3, Bagna, BANGKOK 10260,
Tel. +66 2 361 7910, Fax. +66 2 398 3447

Turkey: Yukari Dudullu, Org. San. Blg., 2.Cad. Nr. 28 81260 Umraniye,
ISTANBUL, Tel. +90 216 522 1500, Fax. +90 216 522 1813

Ukraine: PHILIPS UKRAINE, 4 Patrice Lumumba str., Building B, Floor 7,
252042 KIEV, Tel. +380 44 264 2776, Fax. +380 44 268 0461

United Kingdom: Philips Semiconductors Ltd., 276 Bath Road, Hayes,
MIDDLESEX UB3 5BX, Tel. +44 208 730 5000, Fax. +44 208 754 8421

United States: 811 East Arques Avenue, SUNNYVALE, CA 94088-3409,
Tel. +1 800 234 7381, Fax. +1 800 943 0087

Uruguay: see South America

Vietnam: see Singapore

Yugoslavia: PHILIPS, Trg N. Pasica 5/v, 11000 BEOGRAD,
Tel. +381 11 3341 299, Fax.+381 11 3342 553

For all other countries apply to: Philips Semiconductors,
Marketing Communications, Building BE-p, P.O. Box 218, 5600 MD EINDHOVEN,
The Netherlands, Fax. +31 40 27 24825

Internet: <http://www.semiconductors.philips.com>

© Philips Electronics N.V. 2000

SCA 70

All rights are reserved. Reproduction in whole or in part is prohibited without the prior written consent of the copyright owner.

The information presented in this document does not form part of any quotation or contract, is believed to be accurate and reliable and may be changed without notice. No liability will be accepted by the publisher for any consequence of its use. Publication thereof does not convey nor imply any license under patent- or other industrial or intellectual property rights.

Printed in The Netherlands

budgetnum/printrun/ed/pp11

Date of release: 2000 Nov 15

Document order number: 9397 750 07748

Let's make things better.

Philips
Semiconductors



PHILIPS