

Audio digital potentiometers

BH3532FS

The BH3532FS is a digital potentiometer designed for use in audio devices. Its built-in 22kΩ resistance systems can be used to set the data from the microcomputer in 256 steps.

●Applications

Volume of recording and playing

●Features

- 1) Resistance can be set to any of 256 steps using digital codes (serial data).
- 2) Two built-in channels (Lch, Rch)
- 3) SSOP-A20 package

●Absolute maximum ratings (Ta = 25°C)

| Parameter | Symbol | Limits | Unit |
|-----------------------|------------------|----------|------|
| Power supply voltage | V _{CC} | 7 | V |
| Power dissipation | P _d | 600* | mW |
| Operating temperature | T _{opr} | -25~+75 | °C |
| Storage temperature | T _{stg} | -55~+125 | °C |

* Reduced by 6mW for each increase in Ta of 1°C over 25°C

●Recommended operating conditions (Ta = 25°C)

| Parameter | Symbol | Min. | Typ. | Max. | Unit |
|----------------------|-----------------|------|------|------|------|
| Power supply voltage | V _{DD} | 3 | — | 5.5 | V |

●Block diagram

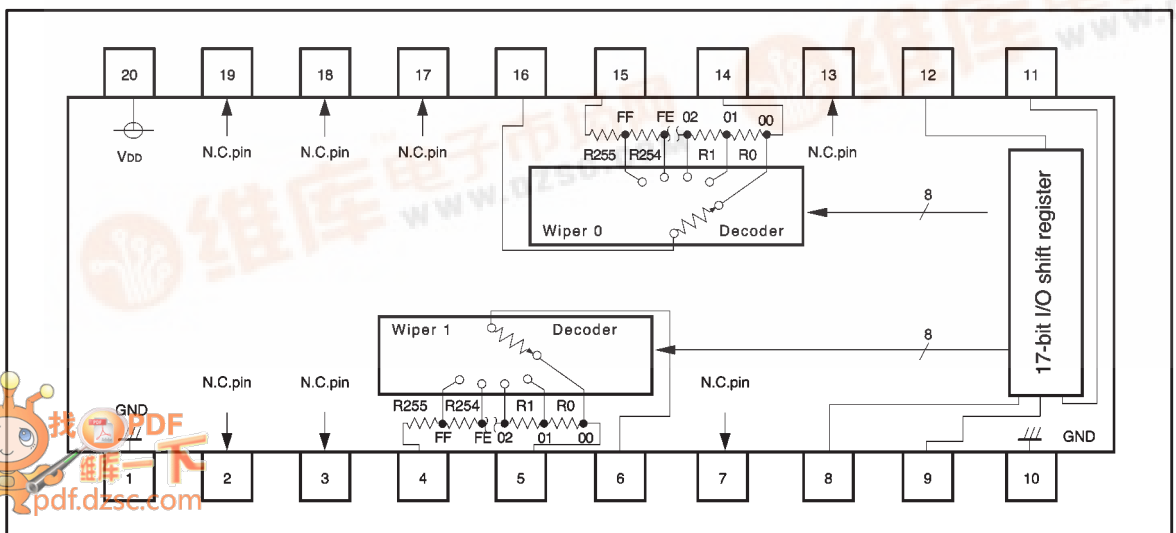

● Pin descriptions

| Pin No. | Pin name | Function | Pin No. | Pin name | Function |
|---------|----------|-------------------------------|---------|-----------------|-------------------------------|
| 1 | GND | GND | 11 | DIN | Serial data input |
| 2 | N.C. | N.C. | 12 | DOUT | Serial data output |
| 3 | N.C. | N.C. | 13 | N.C. | N.C. |
| 4 | H1 | Ch 1 high position resistance | 14 | L0 | Ch 0 low position resistance |
| 5 | L1 | Ch 1 low position resistance | 15 | H0 | Ch 0 high position resistance |
| 6 | W1 | Pin for ch 1 wiper | 16 | W0 | Pin for Ch 0 wiper |
| 7 | N.C. | N.C. | 17 | N.C. | N.C. |
| 8 | EN | Overwrite authorization input | 18 | N.C. | N.C. |
| 9 | CLK | Clock input | 19 | N.C. | N.C. |
| 10 | GND | GND | 20 | V _{DD} | V _{DD} |

* Do not connect anything to the N.C. pin.

● Input/output circuits

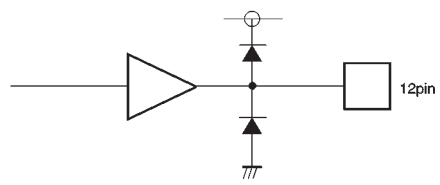
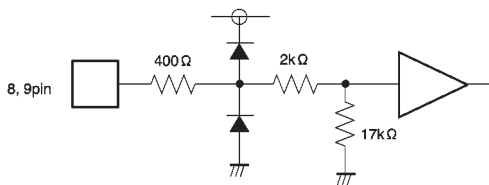
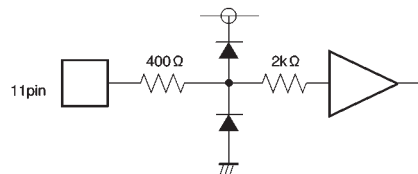
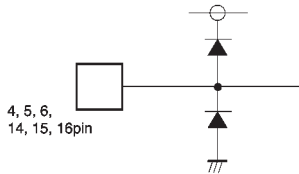

●Circuit operation

The BH3532FS has two 22kΩ variable resistance systems which can be set in 256 steps (86Ω intervals). Resistance can be set in 256 steps using the MSB first 8-bit data. Input data is 17-bit serial data. The first bit is always “L”. The next eight bits set the resistance for wiper 1. The last eight bits set the resistance for wiper 0.

Input data is effective when the EN terminal is set to “H”, and is put on hold when the EN terminal is set to “L”. Also, the reading of the data is performed when CLK rises. When input data is effective, the previous output data is output serially to the DOUT terminal. See the figures below for more details.

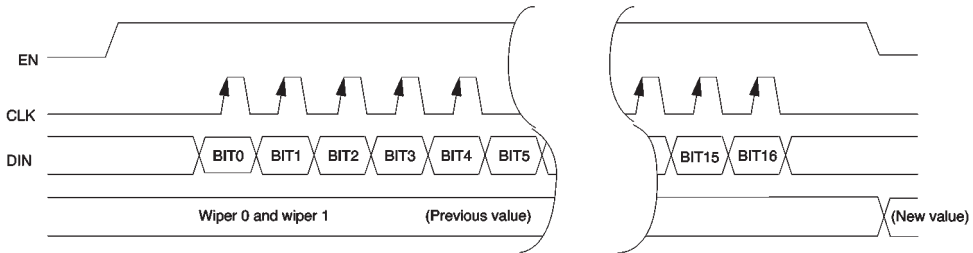

Fig. 2 Timing chart 1

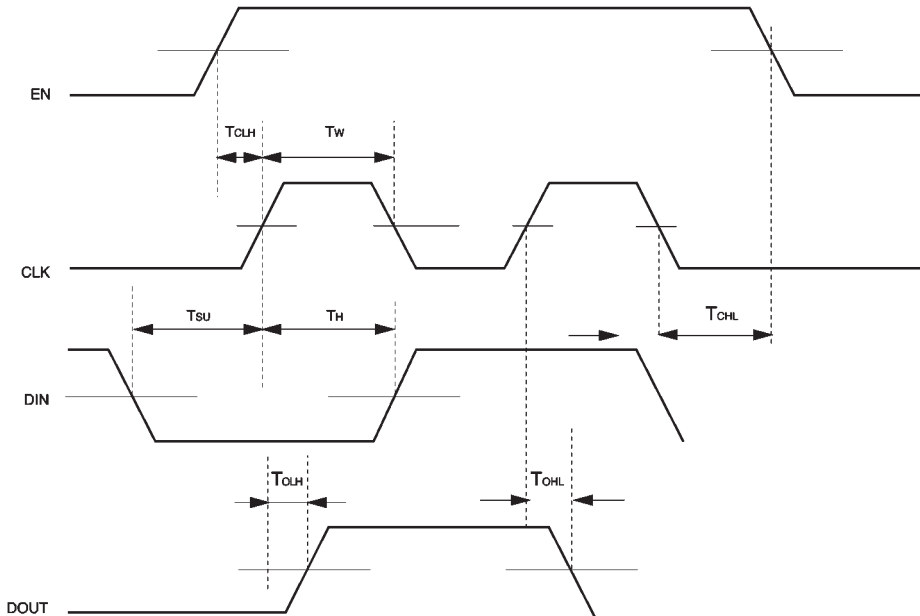

Fig. 3 Timing chart 2

● Electrical characteristic curves

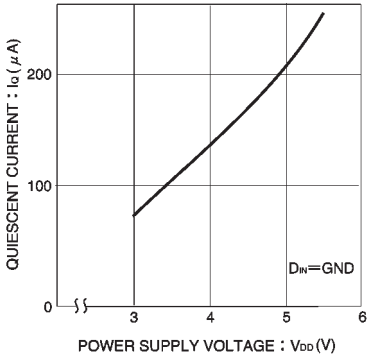

Fig. 4 Power supply voltage vs. quiescent curve

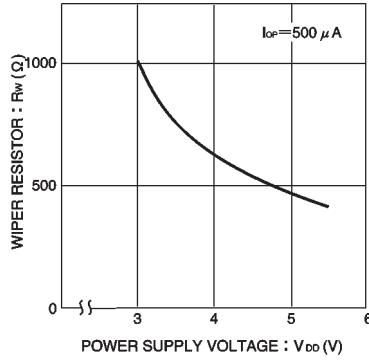

Fig. 5 Power supply voltage vs. wiper resistance

● External dimensions (Units: mm)

