

DISCRETE SEMICONDUCTORS

DATA SHEET

BLF244 VHF power MOS transistor

Product specification

September 1992

VHF power MOS transistor

BLF244

FEATURES

- High power gain
- Low noise figure
- Easy power control
- Good thermal stability
- Withstands full load mismatch
- Gold metallization ensures excellent reliability.

DESCRIPTION

Silicon N-channel enhancement mode vertical D-MOS transistor designed for large signal amplifier applications in the VHF frequency range.

The transistor is encapsulated in a 4-lead SOT123 flange envelope, with a ceramic cap. All leads are isolated from the flange.

Matched gate-source voltage (V_{GS}) groups are available on request.

PINNING - SOT123

PIN	DESCRIPTION
1	drain
2	source
3	gate
4	source

PIN CONFIGURATION

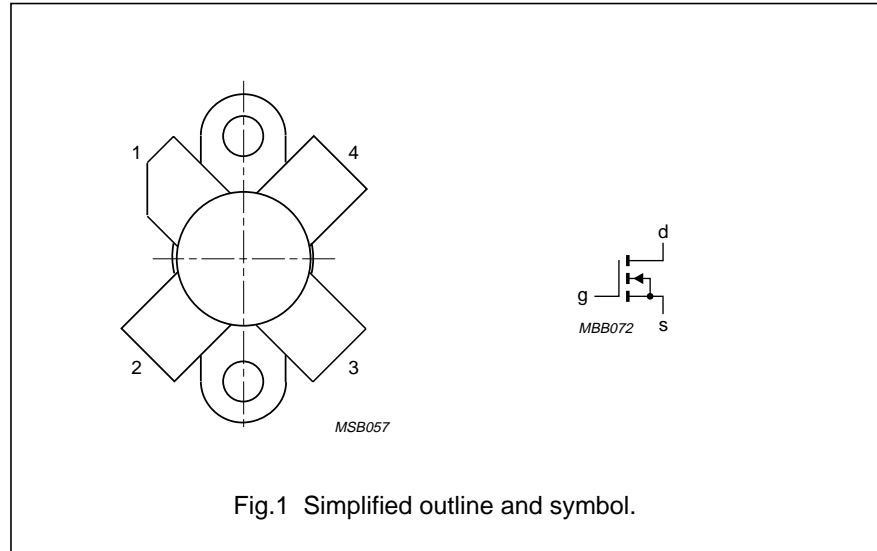

Fig.1 Simplified outline and symbol.

CAUTION

The device is supplied in an antistatic package. The gate-source input must be protected against static charge during transport and handling.

WARNING

Product and environmental safety - toxic materials

This product contains beryllium oxide. The product is entirely safe provided that the BeO disc is not damaged. All persons who handle, use or dispose of this product should be aware of its nature and of the necessary safety precautions. After use, dispose of as chemical or special waste according to the regulations applying at the location of the user. It must never be thrown out with the general or domestic waste.

QUICK REFERENCE DATA

RF performance at $T_h = 25\text{ }^\circ\text{C}$ in a common source test circuit.

MODE OF OPERATION	f (MHz)	V_{DS} (V)	P_L (W)	G_p (dB)	η_D (%)
CW, class-B	175	28	15	> 13	> 50

VHF power MOS transistor

BLF244

LIMITING VALUES

In accordance with the Absolute Maximum System (IEC 134).

SYMBOL	PARAMETER	CONDITIONS	MIN.	MAX.	UNIT
V_{DS}	drain-source voltage		–	65	V
$\pm V_{GS}$	gate-source voltage		–	20	V
I_D	DC drain current		–	3	A
P_{tot}	total power dissipation	up to $T_{mb} = 25\text{ }^\circ\text{C}$	–	38	W
T_{stg}	storage temperature		–65	150	$^\circ\text{C}$
T_j	junction temperature		–	200	$^\circ\text{C}$

THERMAL RESISTANCE

SYMBOL	PARAMETER	CONDITIONS	THERMAL RESISTANCE
$R_{th\ j-mb}$	thermal resistance from junction to mounting base	$T_{mb} = 25\text{ }^\circ\text{C}$; $P_{tot} = 38\text{ W}$	4.6 K/W
$R_{th\ mb-h}$	thermal resistance from mounting base to heatsink	$T_{mb} = 25\text{ }^\circ\text{C}$; $P_{tot} = 38\text{ W}$	0.3 K/W

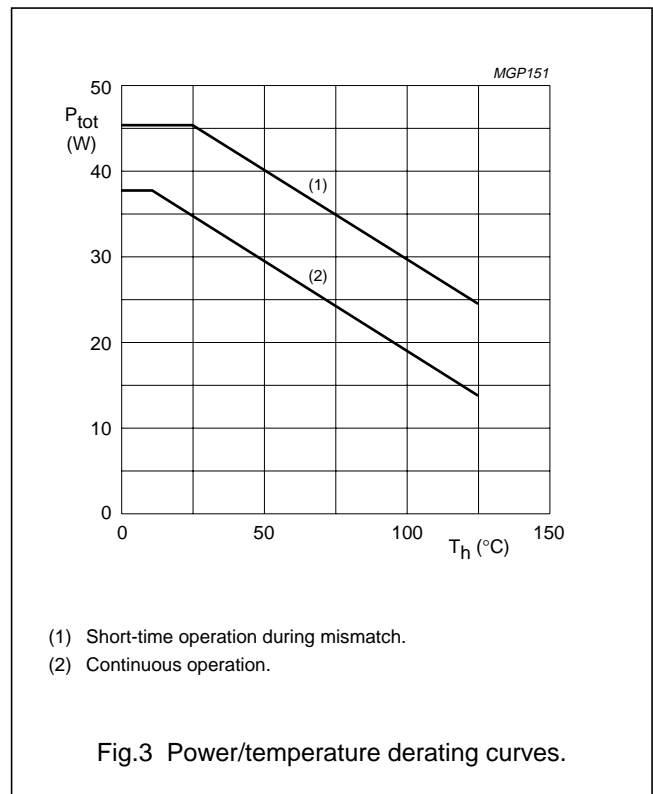
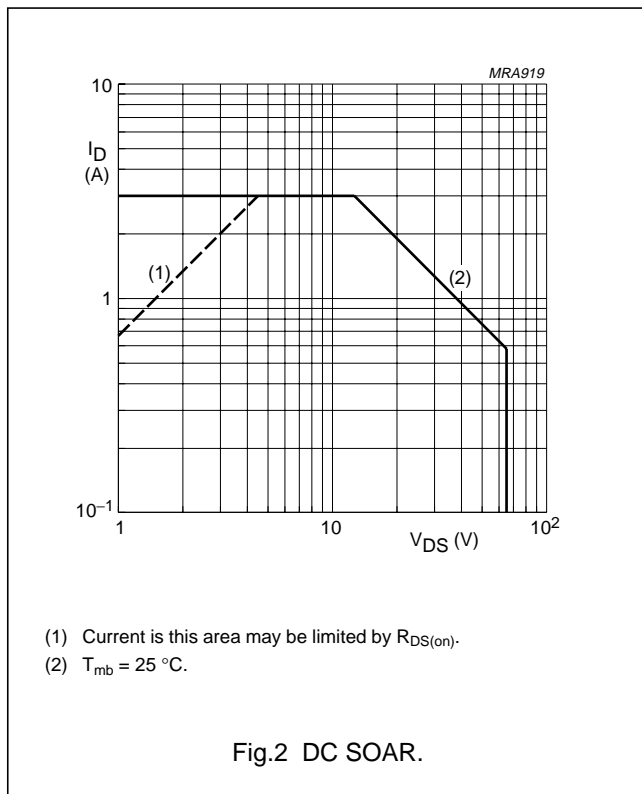

VHF power MOS transistor

BLF244

CHARACTERISTICS

$T_j = 25\text{ }^\circ\text{C}$ unless otherwise specified.

SYMBOL	PARAMETER	CONDITIONS	MIN.	TYP.	MAX.	UNIT
$V_{(BR)DSS}$	drain-source breakdown voltage	$V_{GS} = 0; I_D = 5\text{ mA}$	65	–	–	V
I_{DSS}	drain-source leakage current	$V_{GS} = 0; V_{DS} = 28\text{ V}$	–	–	1	mA
I_{GSS}	gate-source leakage current	$\pm V_{GS} = 20\text{ V}; V_{DS} = 0$	–	–	1	μA
$V_{GS(th)}$	gate-source threshold voltage	$I_D = 5\text{ mA}; V_{DS} = 10\text{ V}$	2	–	4.5	V
ΔV_{GS}	gate-source voltage difference of matched devices	$I_D = 5\text{ mA}; V_{DS} = 10\text{ V}$	–	–	100	mV
g_{fs}	forward transconductance	$I_D = 0.75\text{ A}; V_{DS} = 10\text{ V}$	0.6	–	–	S
$R_{DS(on)}$	drain-source on-state resistance	$I_D = 0.75\text{ A}; V_{GS} = 10\text{ V}$	–	0.8	1.5	Ω
I_{DSX}	on-state drain current	$V_{GS} = 10\text{ V}; V_{DS} = 10\text{ V}$	–	5	–	A
C_{is}	input capacitance	$V_{GS} = 0; V_{DS} = 28\text{ V}; f = 1\text{ MHz}$	–	60	–	pF
C_{os}	output capacitance	$V_{GS} = 0; V_{DS} = 28\text{ V}; f = 1\text{ MHz}$	–	40	–	pF
C_{rs}	feedback capacitance	$V_{GS} = 0; V_{DS} = 28\text{ V}; f = 1\text{ MHz}$	–	4.5	–	pF
F	noise figure (see Fig. 13)	$I_D = 0.5\text{ A}; V_{DS} = 28\text{ V}; R_1 = 23\text{ }\Omega;$ $T_h = 25\text{ }^\circ\text{C}; f = 175\text{ MHz};$ $R_{th\text{ mb-h}} = 0.3\text{ K/W}$	–	4.3	–	dB

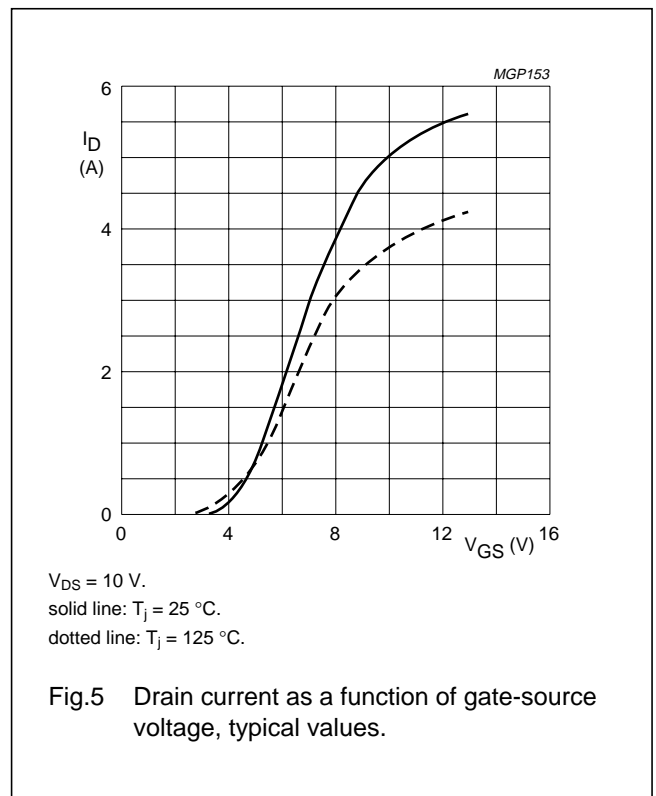
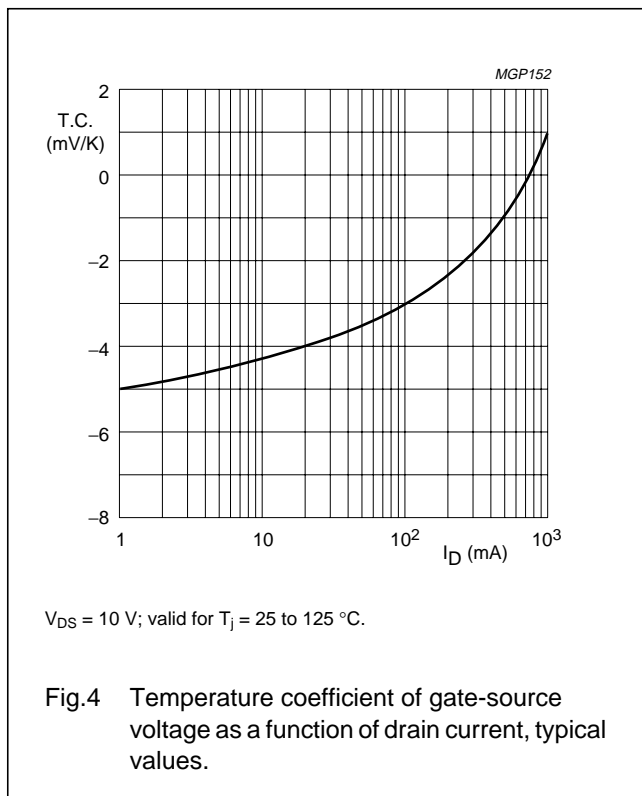

VHF power MOS transistor

BLF244

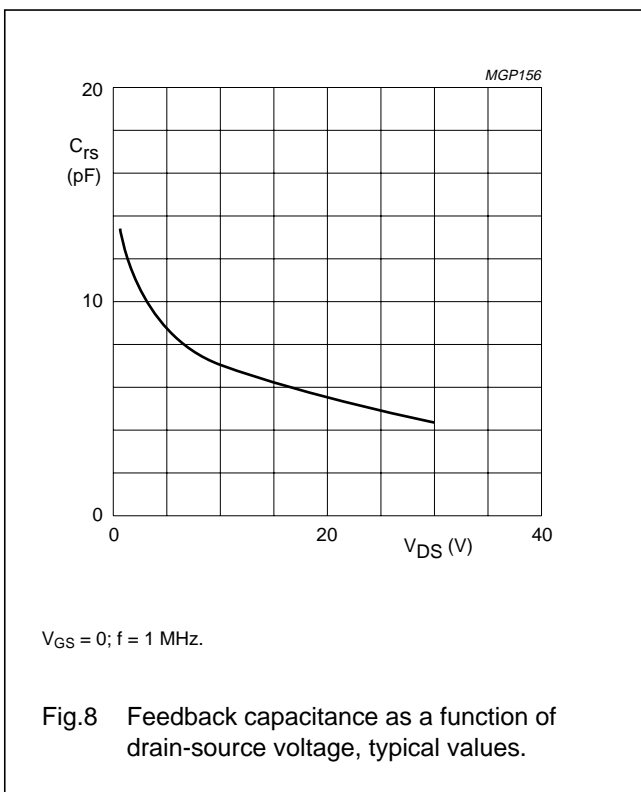
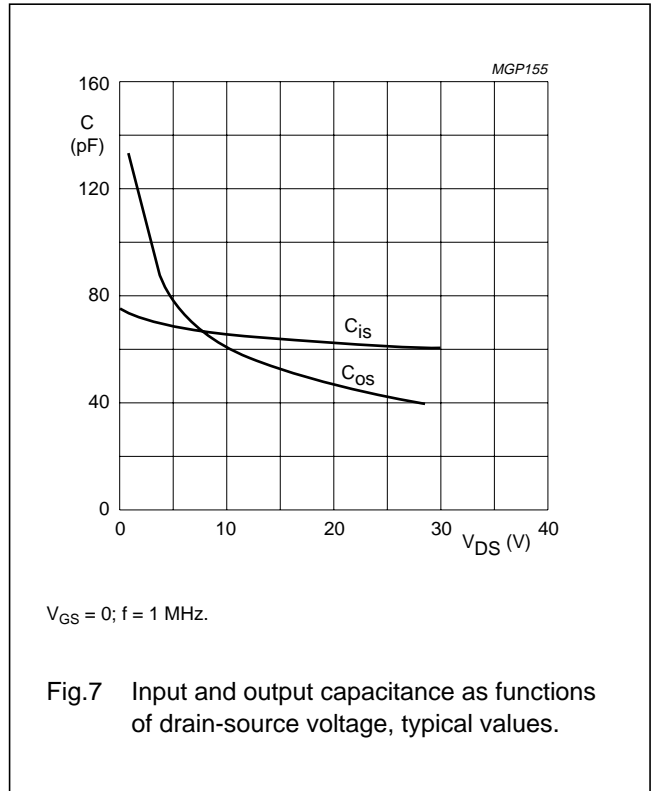
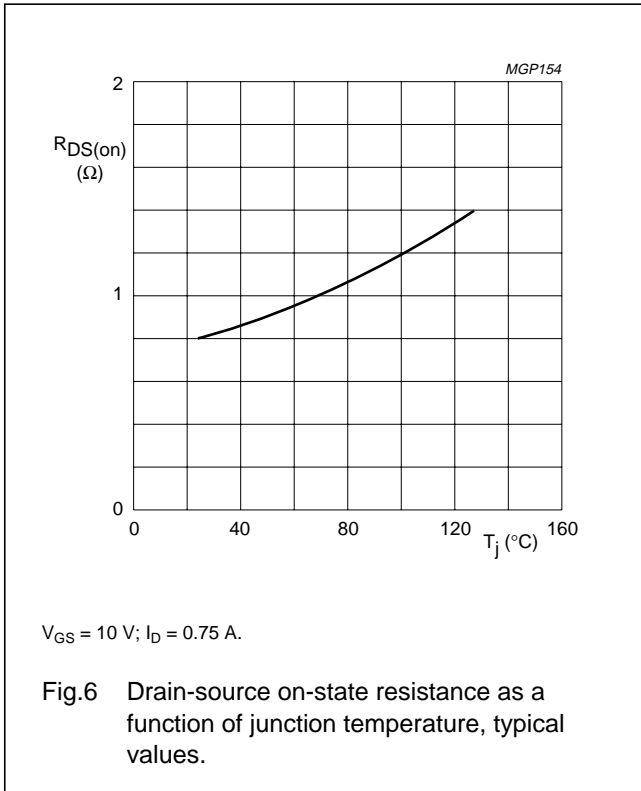

VHF power MOS transistor

BLF244

APPLICATION INFORMATION FOR CLASS-B OPERATION

$T_h = 25\text{ }^\circ\text{C}$; $R_{th\text{ mb-h}} = 3\text{ K/W}$; unless otherwise specified.

RF performance in CW operation in a common source class-B circuit.

MODE OF OPERATION	f (MHz)	V _{DS} (V)	I _{DQ} (mA)	P _L (W)	G _p (dB)	η _D (%)	Z _i (Ω) (note 1)	Z _L (Ω)	R1 (Ω)
CW, class-B	175	28	25	15	> 13 typ. 17	> 50 typ. 65	3.0 - j4.0	6.3 + j9.8	46.4//46.4
	175	12.5	25	6	typ. 15	typ. 60	3.0 - j4.0	4.5 + j3.3	100

Note

- 1. R1 included.

Ruggedness in class-B operation

The BLF244 is capable of withstanding a load mismatch corresponding to VSWR = 50 through all phases under the following conditions:

$T_h = 25\text{ }^\circ\text{C}$; $R_{th\text{ mb-h}} = 0.3\text{ K/W}$; at rated load power.

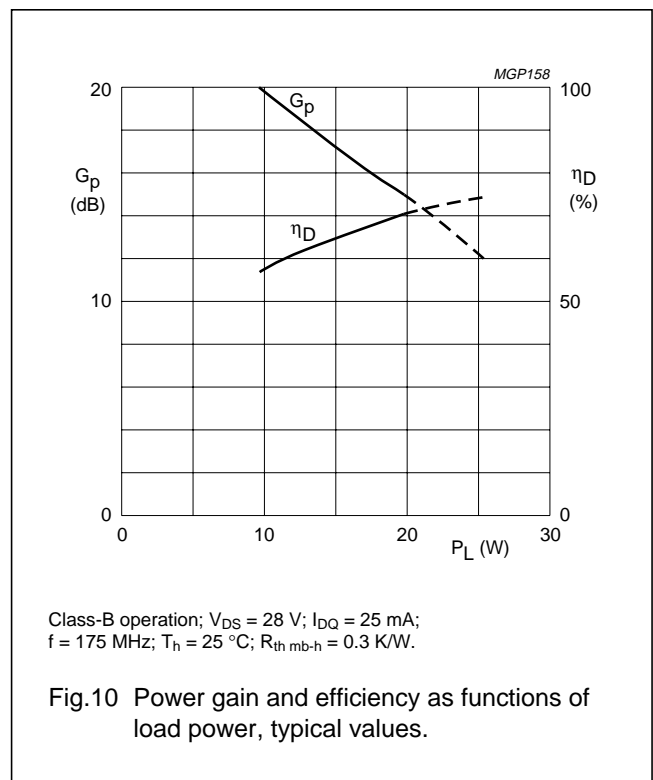
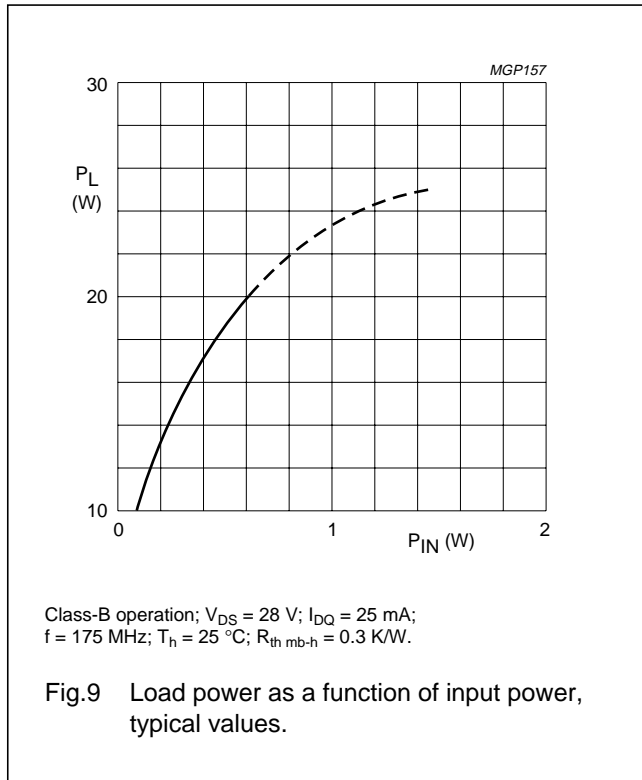

VHF power MOS transistor

BLF244

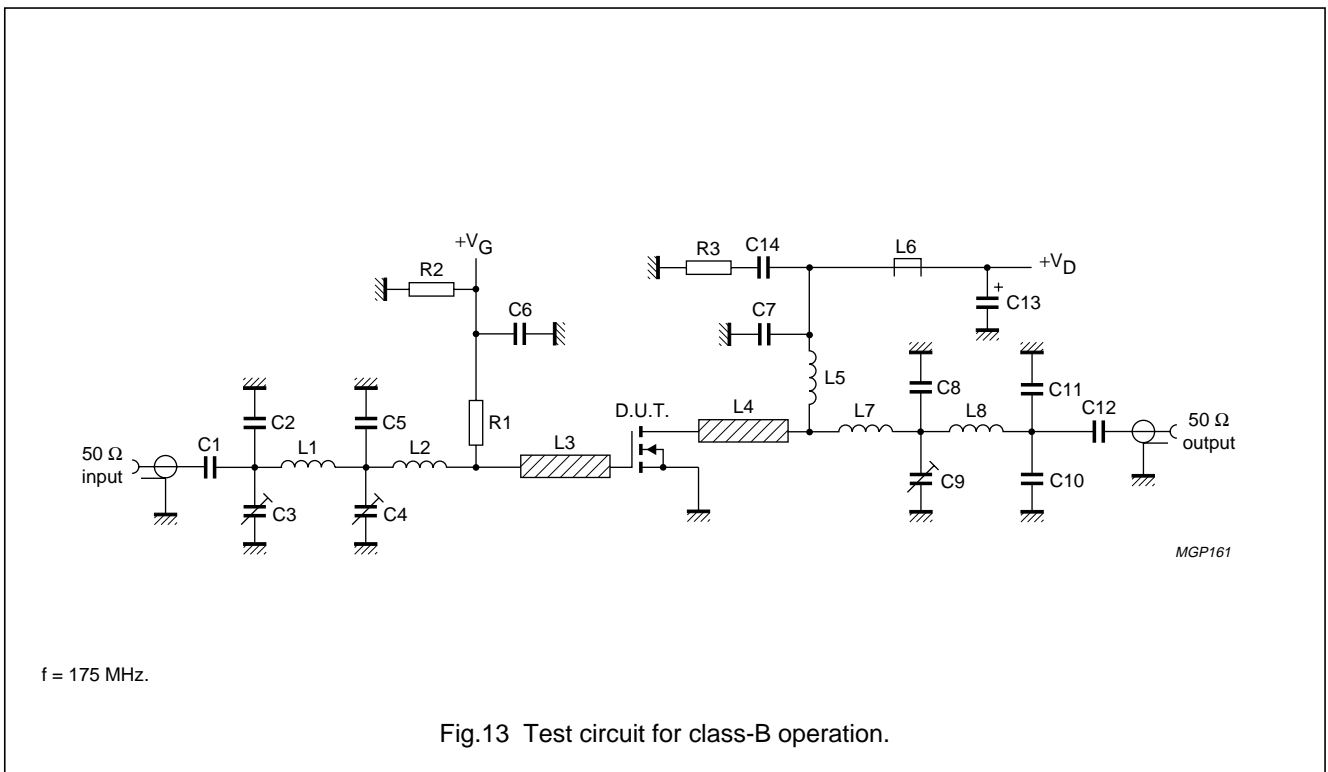
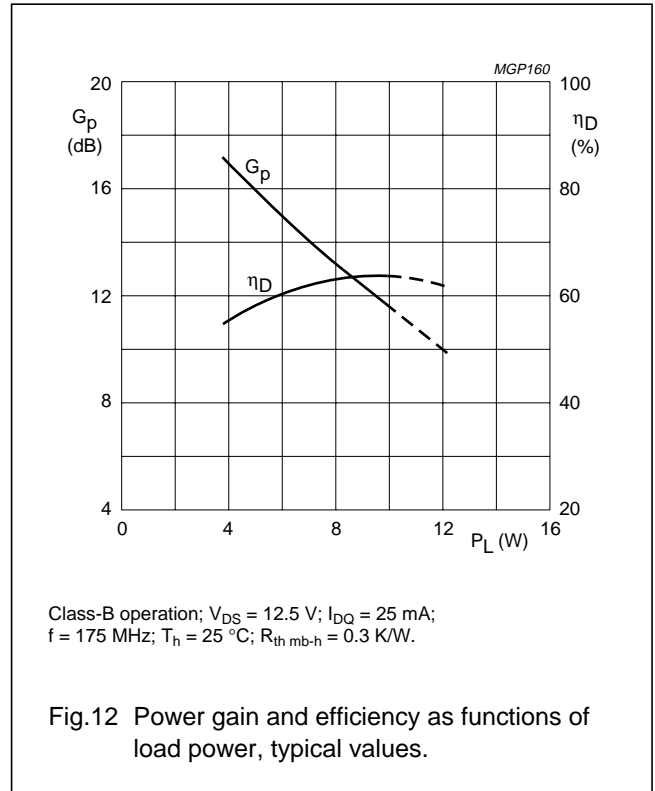
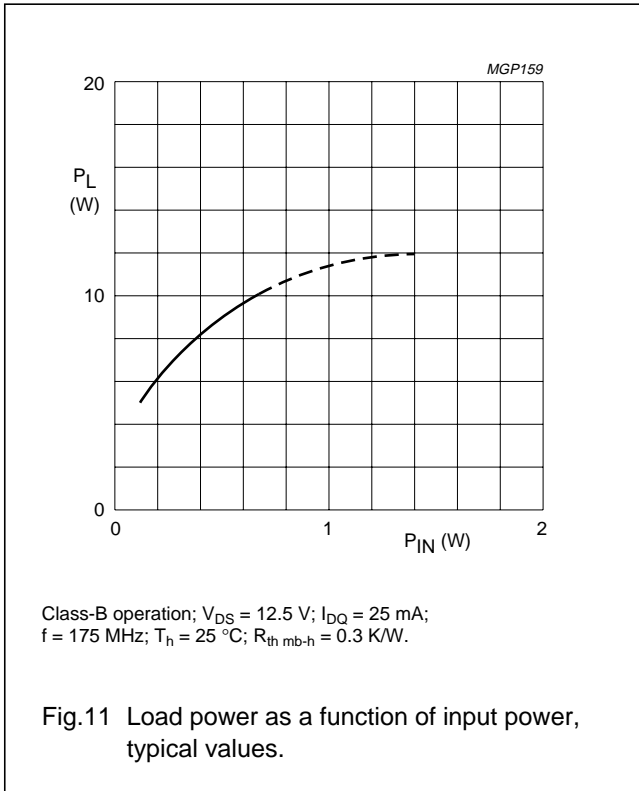

VHF power MOS transistor

BLF244

List of components (class-B test circuit)

COMPONENT	DESCRIPTION	VALUE	DIMENSIONS	CATALOGUE NO.
C1, C12	multilayer ceramic chip capacitor (note 1)	680 nF		
C2	multilayer ceramic chip capacitor (note 1)	20 pF		
C3, C4, C9	film dielectric trimmer	5 to 60 pF		2222 809 08003
C5	multilayer ceramic chip capacitor (note 1)	75 pF		
C6	multilayer ceramic chip capacitor	10 nF		2222 852 47103
C7	multilayer ceramic chip capacitor (note 1)	100 pF		
C8	multilayer ceramic chip capacitor (note 1)	47 pF		
C10, C11	multilayer ceramic chip capacitor (note 1)	11 pF		
C13	solid tantalum capacitor	2.2 μ F		
C14	multilayer ceramic chip capacitor	100 nF		2222 852 47104
L1	4 turns enamelled 1 mm copper wire	32 nH	length 6.3 mm int. dia. 3 mm leads 2 \times 5 mm	
L2	1 turn enamelled 1 mm copper wire	12.2 nH	int. dia. 5.6 mm leads 2 \times 5 mm	
L3, L4	stripline (note 2)	30 Ω	15 \times 6 mm	
L5	6 turns enamelled 1 mm copper wire	119 nH	length 10.4 mm int. dia. 6 mm leads 2 \times 5 mm	
L6	grade 3B Ferroxcube RF choke			4312 020 36640
L7	2 turns enamelled 1 mm copper wire	19 nH	length 2.4 mm int. dia. 3 mm leads 2 \times 5 mm	
L8	4 turns enamelled 1 mm copper wire	28.5 nH	length 8.5 mm int. dia. 3 mm leads 2 \times 5 mm	
R1	metal film resistor (note 3)			
R2	0.4 W metal film resistor	1 M Ω		
R3	0.4 W metal film resistor	10 Ω		

Notes

- American Technical Ceramics (ATC) capacitor, type 100B or other capacitor of the same quality.
- The striplines are on a double copper-clad printed circuit board, with epoxy fibre-glass dielectric ($\epsilon_r = 4.5$), thickness $\frac{1}{16}$ inch.
- Refer to Application Information for value.

VHF power MOS transistor

BLF244

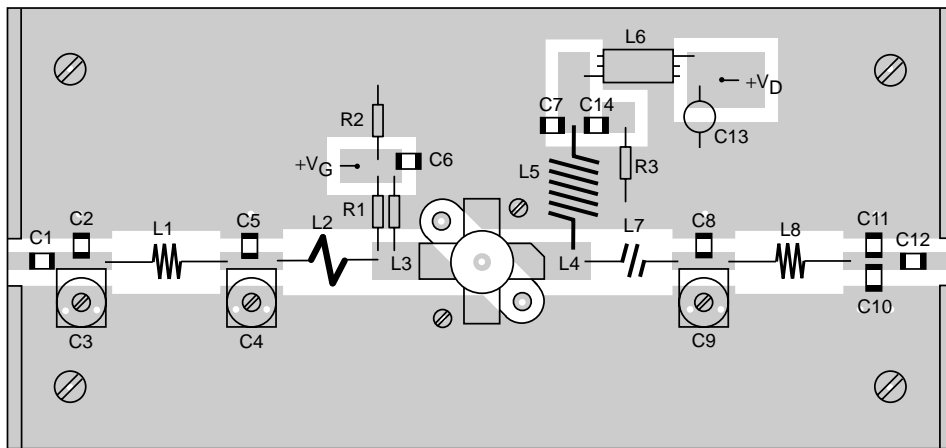
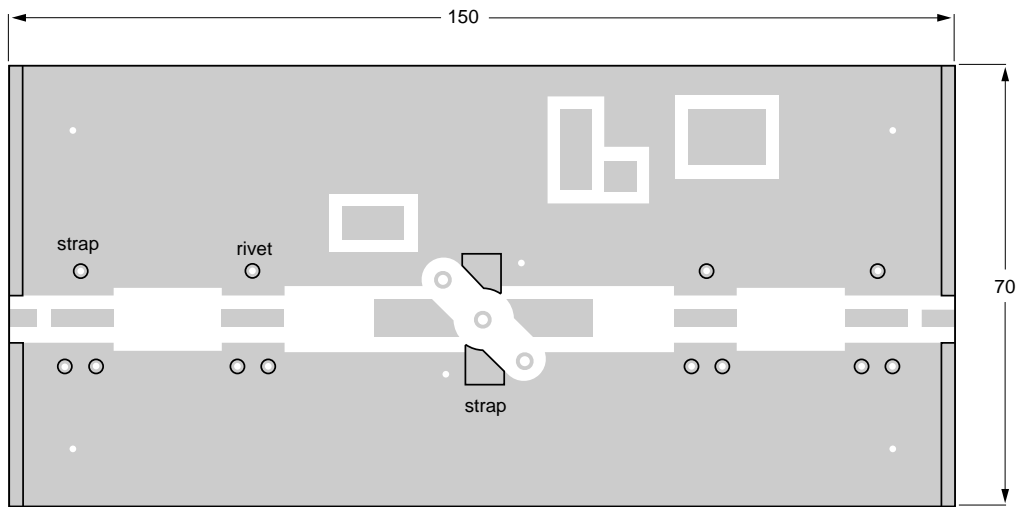

MGP162

The circuit and components are situated on one side of the epoxy fibre-glass board, the other side being unetched copper to serve as ground plane. Earth connections are made by fixing screws, copper straps and hollow rivets under the sources and around the edges to provide a direct contact between the copper on the component side and the ground plane.

Dimensions in mm.

Fig.14 Component layout for 175 MHz class-B test circuit.

VHF power MOS transistor

BLF244

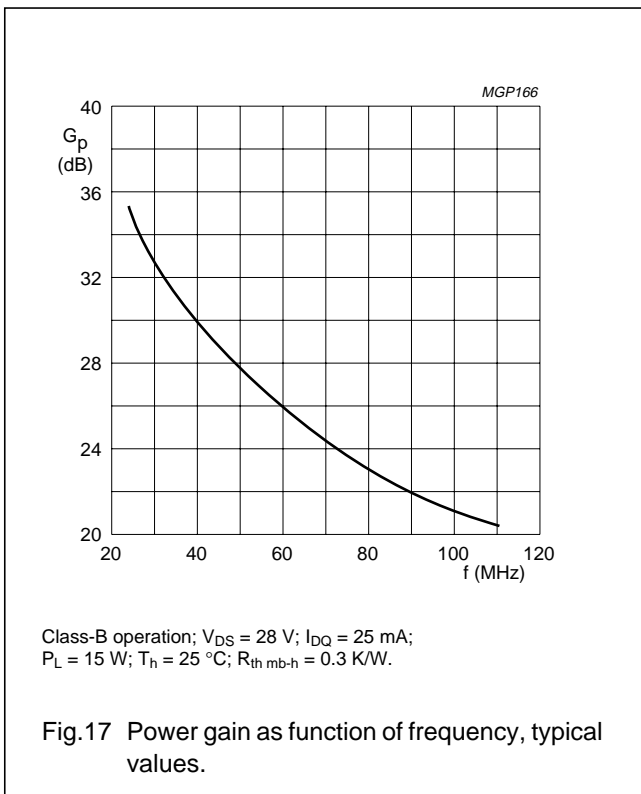
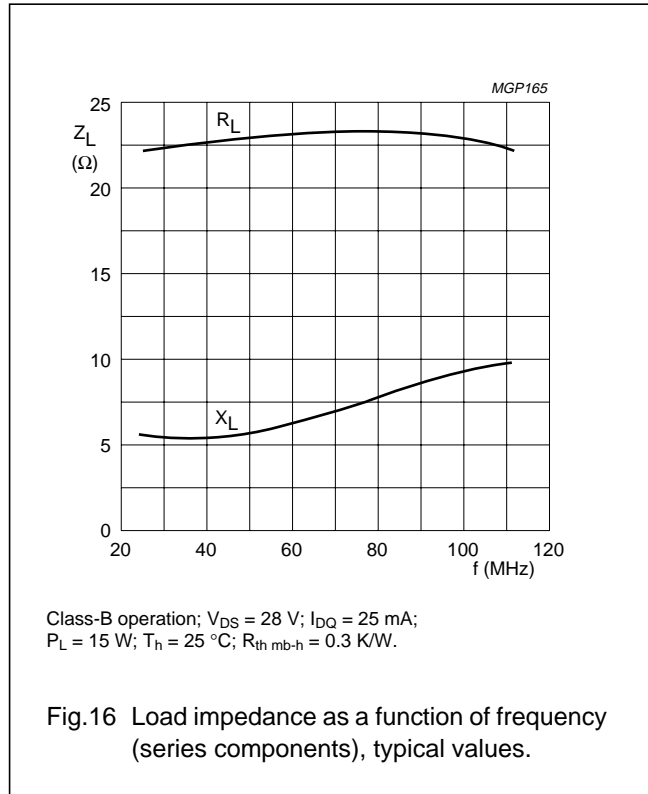
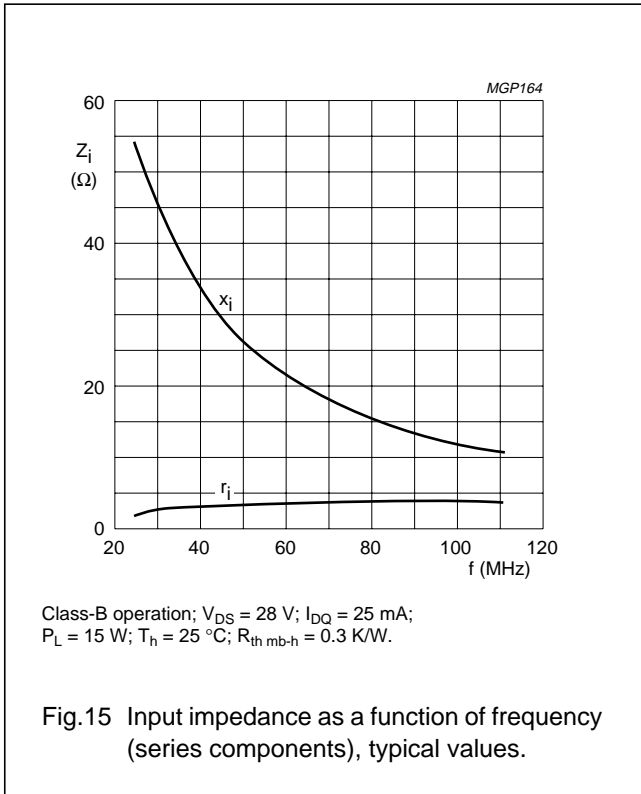

VHF power MOS transistor

BLF244

PACKAGE OUTLINE

Flanged ceramic package; 2 mounting holes; 4 leads

SOT123A

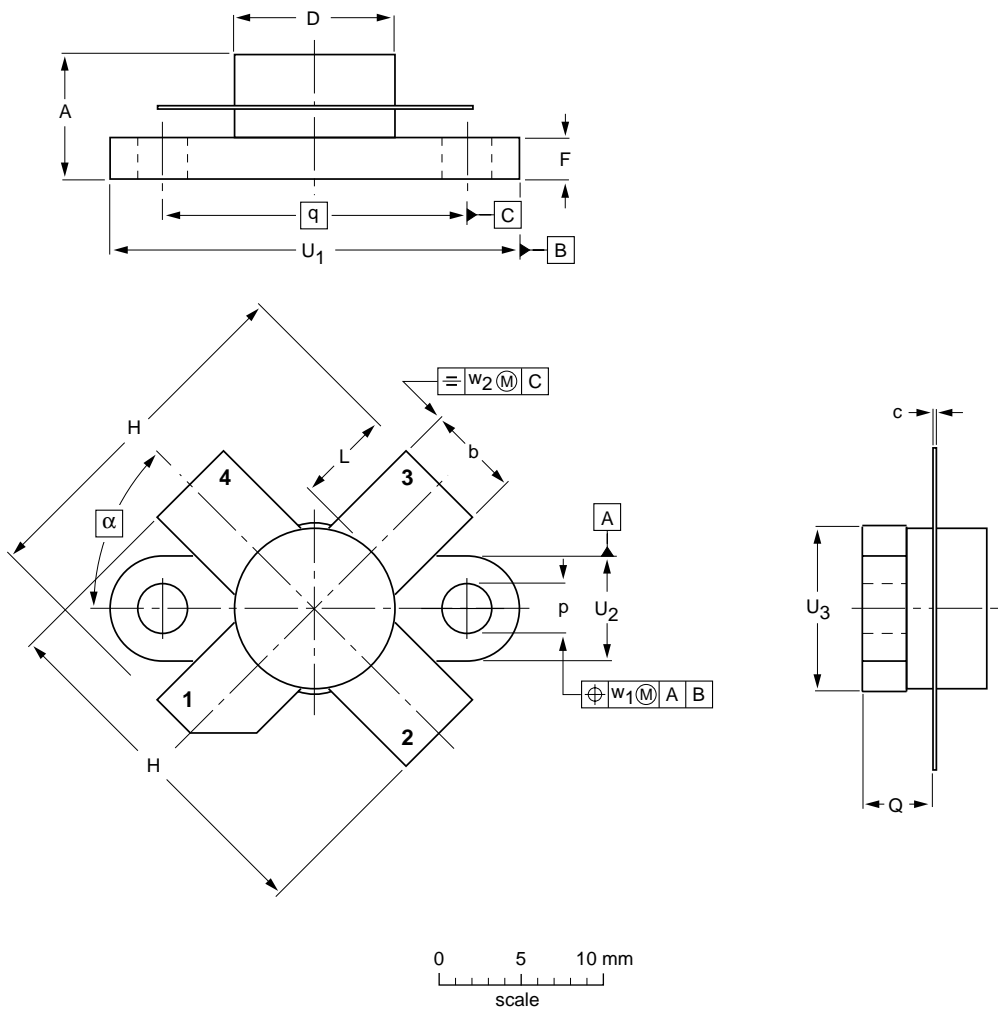

DIMENSIONS (millimetre dimensions are derived from the original inch dimensions)

UNIT	A	b	c	D	D ₁	F	H	L	p	Q	q	U ₁	U ₂	U ₃	w ₁	w ₂	α
mm	7.47 6.37	5.82 5.56	0.18 0.10	9.73 9.47	9.63 9.42	2.72 2.31	20.71 19.93	5.61 5.16	3.33 3.04	4.63 4.11	18.42	25.15 24.38	6.61 6.09	9.78 9.39	0.51	1.02	45°
inches	0.294 0.251	0.229 0.219	0.007 0.004	0.383 0.373	0.397 0.371	0.107 0.091	0.815 0.785	0.221 0.203	0.131 0.120	0.182 0.162	0.725	0.99 0.96	0.26 0.24	0.385 0.370	0.02	0.04	

OUTLINE VERSION	REFERENCES			EUROPEAN PROJECTION	ISSUE DATE
	IEC	JEDEC	EIAJ		
SOT123A					97-06-28

VHF power MOS transistor

BLF244

DEFINITIONS

Data Sheet Status	
Objective specification	This data sheet contains target or goal specifications for product development.
Preliminary specification	This data sheet contains preliminary data; supplementary data may be published later.
Product specification	This data sheet contains final product specifications.
Limiting values	
Limiting values given are in accordance with the Absolute Maximum Rating System (IEC 134). Stress above one or more of the limiting values may cause permanent damage to the device. These are stress ratings only and operation of the device at these or at any other conditions above those given in the Characteristics sections of the specification is not implied. Exposure to limiting values for extended periods may affect device reliability.	
Application information	
Where application information is given, it is advisory and does not form part of the specification.	

LIFE SUPPORT APPLICATIONS

These products are not designed for use in life support appliances, devices, or systems where malfunction of these products can reasonably be expected to result in personal injury. Philips customers using or selling these products for use in such applications do so at their own risk and agree to fully indemnify Philips for any damages resulting from such improper use or sale.