

**DISCRETE SEMICONDUCTORS**

# DATA SHEET

**BLF277**

VHF power MOS transistor

Product specification

September 1992

# VHF power MOS transistor

# BLF277

### FEATURES

- High power gain
- Easy power control
- Gold metallization ensures excellent reliability
- Good thermal stability
- Withstands full load mismatch.

### DESCRIPTION

Silicon N-channel enhancement mode vertical D-MOS transistor designed for large signal amplifier applications in the VHF frequency range.

The transistor is encapsulated in a 6-lead, SOT119 flange envelope, with a ceramic cap. All leads are isolated from the flange.

A marking code, showing gate-source voltage ( $V_{GS}$ ) information is provided for matched pair applications. Refer to the 'General' section for further information.

### PIN CONFIGURATION

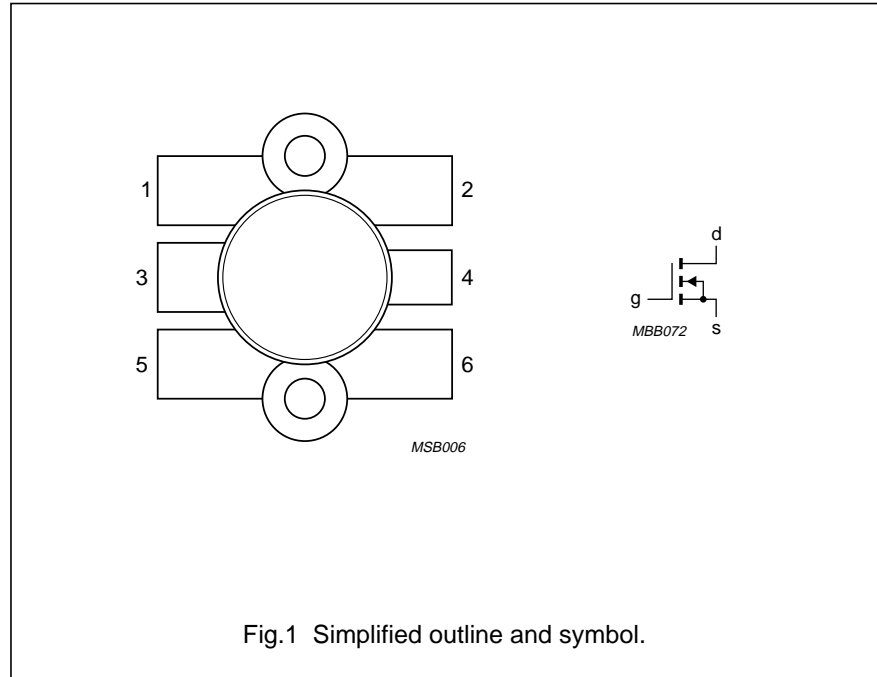

Fig.1 Simplified outline and symbol.

### CAUTION

The device is supplied in an antistatic package. The gate-source input must be protected against static charge during transport and handling.

### PINNING - SOT119

PIN	DESCRIPTION
1	source
2	source
3	gate
4	drain
5	source
6	source

### WARNING

**Product and environmental safety - toxic materials**

This product contains beryllium oxide. The product is entirely safe provided that the BeO disc is not damaged. All persons who handle, use or dispose of this product should be aware of its nature and of the necessary safety precautions. After use, dispose of as chemical or special waste according to the regulations applying at the location of the user. It must never be thrown out with the general or domestic waste.

### QUICK REFERENCE DATA

RF performance at  $T_h = 25\text{ }^\circ\text{C}$  in a common source circuit.

MODE OF OPERATION	f (MHz)	$V_{DS}$ (V)	$P_L$ (W)	$G_p$ (dB)	$\eta_D$ (%)
CW, class-B	175	50	150	> 14	> 50

VHF power MOS transistor

BLF277

**LIMITING VALUES**

In accordance with the Absolute Maximum System (IEC 134).

SYMBOL	PARAMETER	CONDITIONS	MIN.	MAX.	UNIT
$V_{DS}$	drain-source voltage		–	110	V
$\pm V_{GS}$	gate-source voltage		–	20	V
$I_D$	DC drain current		–	16	A
$P_{tot}$	total power dissipation	up to $T_{mb} = 25\text{ }^\circ\text{C}$	–	220	W
$T_{stg}$	storage temperature		–65	150	$^\circ\text{C}$
$T_j$	junction temperature		–	200	$^\circ\text{C}$

**THERMAL RESISTANCE**

SYMBOL	PARAMETER	CONDITIONS	THERMAL RESISTANCE
$R_{th\ j-mb}$	thermal resistance from junction to mounting base	$T_{mb} = 25\text{ }^\circ\text{C}; P_{tot} = 220\text{ W}$	0.8 K/W
$R_{th\ mb-h}$	thermal resistance from mounting base to heatsink	$T_{mb} = 25\text{ }^\circ\text{C}; P_{tot} = 220\text{ W}$	0.2 K/W

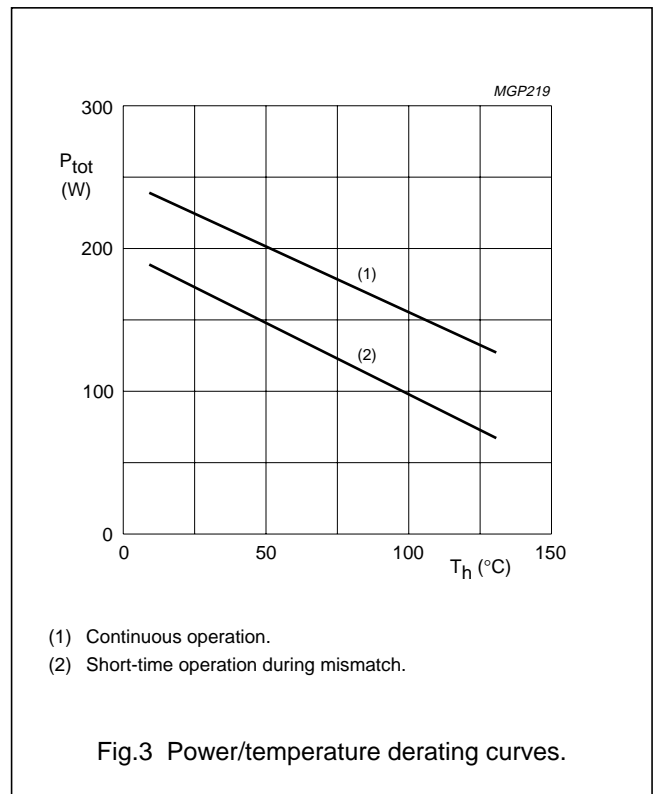
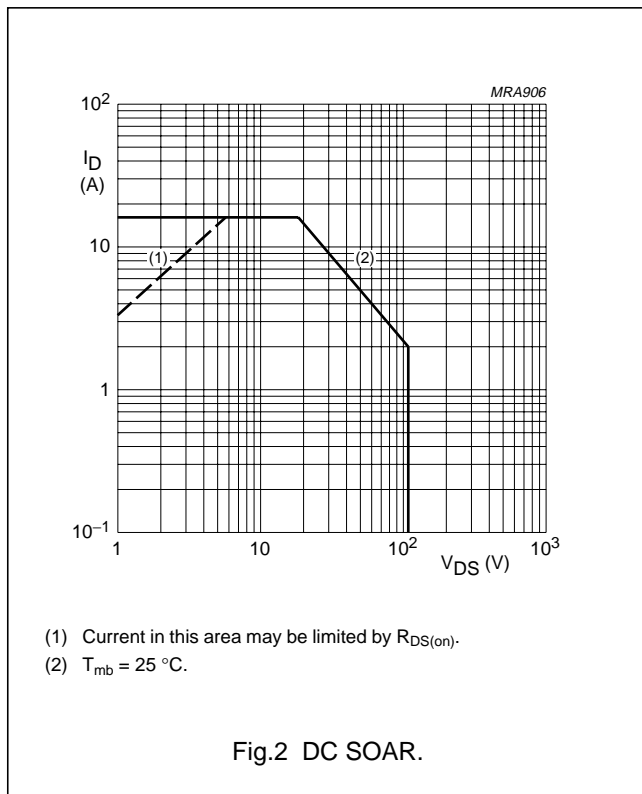

VHF power MOS transistor

BLF277

CHARACTERISTICS

T<sub>j</sub> = 25 °C unless otherwise specified.

SYMBOL	PARAMETER	CONDITIONS	MIN.	TYP.	MAX.	UNIT
V <sub>(BR)DSS</sub>	drain-source breakdown voltage	V <sub>GS</sub> = 0; I <sub>D</sub> = 50 mA	110	–	–	V
I <sub>DSS</sub>	drain-source leakage current	V <sub>GS</sub> = 0; V <sub>DS</sub> = 50 V	–	–	2.5	mA
I <sub>GSS</sub>	gate-source leakage current	±V <sub>GS</sub> = 20 V; V <sub>DS</sub> = 0	–	–	1	µA
V <sub>GS(th)</sub>	gate-source threshold voltage	I <sub>D</sub> = 50 mA; V <sub>DS</sub> = 10 V	2	–	4.5	V
ΔV <sub>GS</sub>	gate-source voltage difference of matched pairs	I <sub>D</sub> = 50 mA; V <sub>DS</sub> = 10 V	–	–	100	mV
g <sub>fs</sub>	forward transconductance	I <sub>D</sub> = 5 A; V <sub>DS</sub> = 10 V	4.5	6.2	–	S
R <sub>DS(on)</sub>	drain-source on-state resistance	I <sub>D</sub> = 5 A; V <sub>GS</sub> = 10 V	–	0.2	0.3	Ω
I <sub>DSX</sub>	on-state drain current	V <sub>GS</sub> = 10 V; V <sub>DS</sub> = 10 V	–	25	–	A
C <sub>is</sub>	input capacitance	V <sub>GS</sub> = 0; V <sub>DS</sub> = 50 V; f = 1 MHz	–	480	–	pF
C <sub>os</sub>	output capacitance	V <sub>GS</sub> = 0; V <sub>DS</sub> = 50 V; f = 1 MHz	–	190	–	pF
C <sub>rs</sub>	feedback capacitance	V <sub>GS</sub> = 0; V <sub>DS</sub> = 50 V; f = 1 MHz	–	14	–	pF

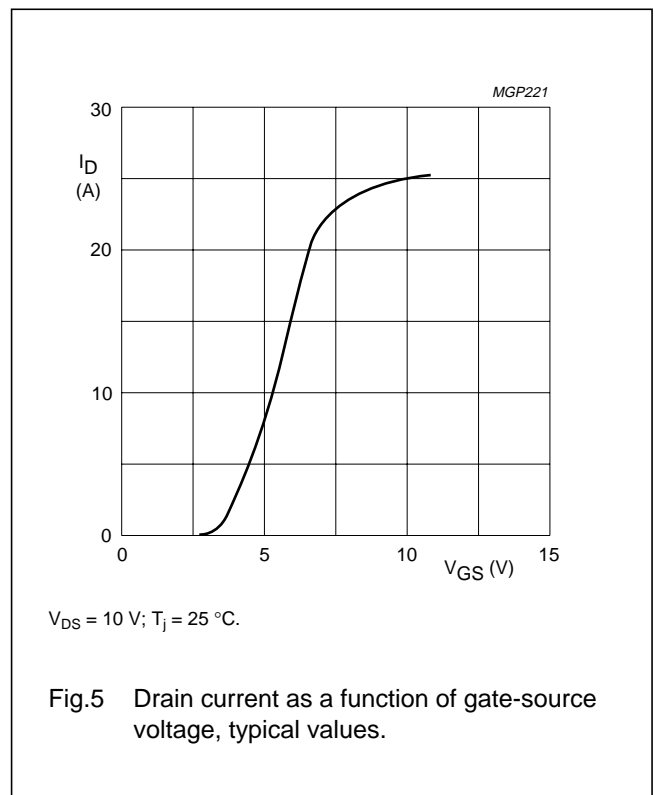
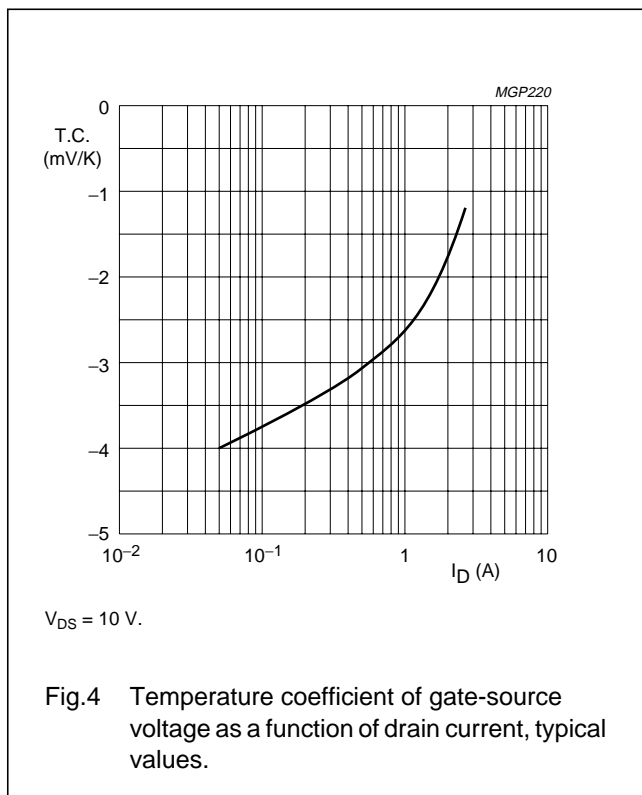

VHF power MOS transistor

BLF277

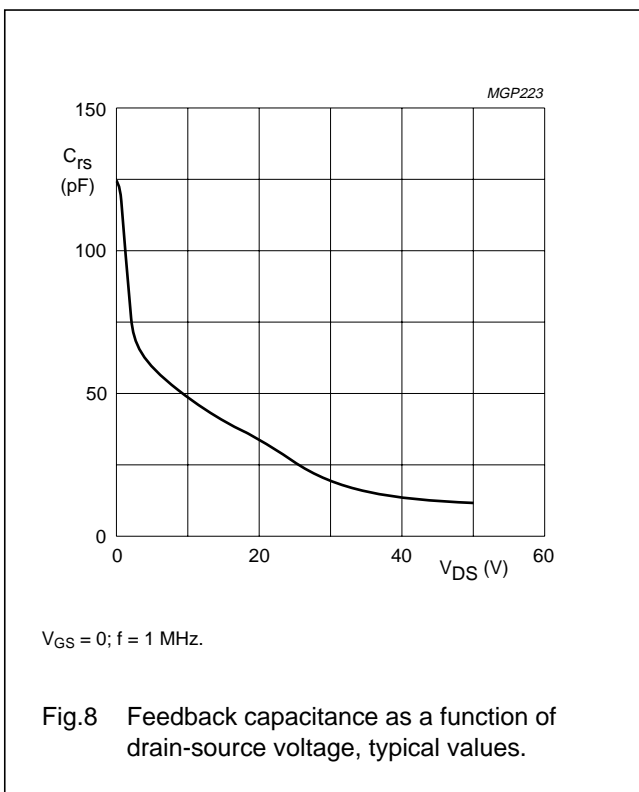
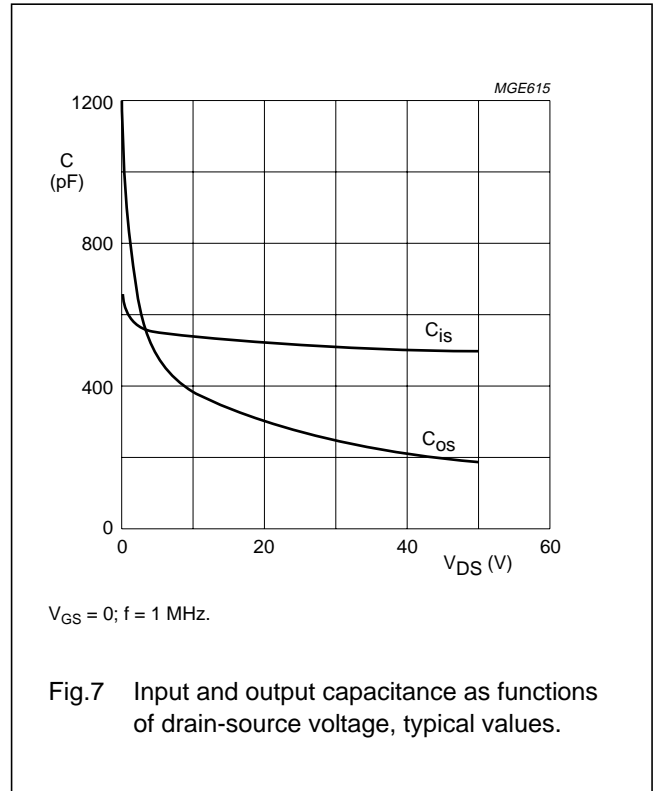
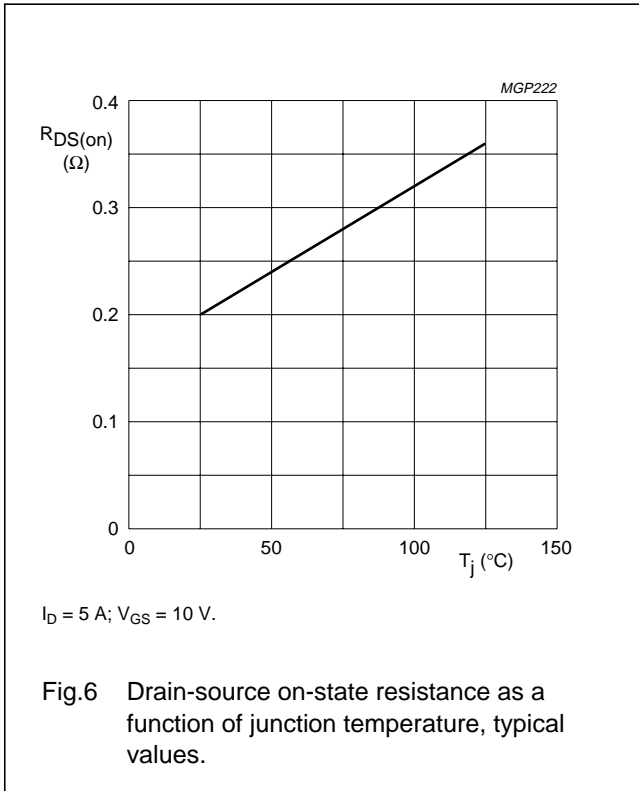

VHF power MOS transistor

BLF277

APPLICATION INFORMATION FOR CLASS-B OPERATION

$T_h = 25\text{ }^\circ\text{C}$ ;  $R_{th\text{ mb-h}} = 0.2\text{ K/W}$ ;  $R_{GS} = 16\text{ }\Omega$ ; unless otherwise specified.

RF performance in CW operation in a common source class-B test circuit.

MODE OF OPERATION	f (MHz)	$V_{DS}$ (V)	$I_{DQ}$ (A)	$P_L$ (W)	$G_p$ (dB)	$\eta_D$ (%)
CW, class-B	175	50	0.1	150	> 14 typ. 17	> 50 typ. 58

Ruggedness in class-B operation

The BLF277 is capable of withstanding a load mismatch corresponding to  $V_{SWR} = 50$  through all phases under the following conditions:

$V_{DS} = 50\text{ V}$ ;  $f = 175\text{ MHz}$  at rated load power.

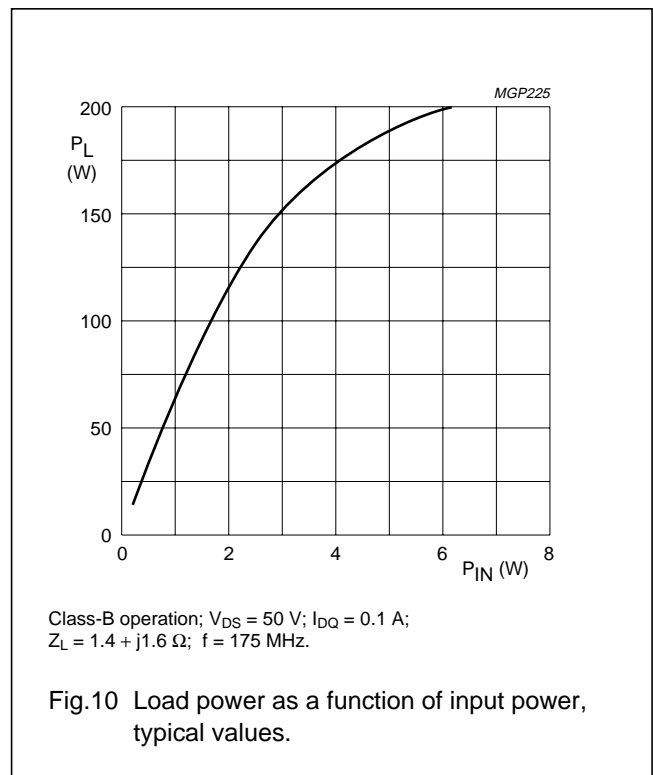
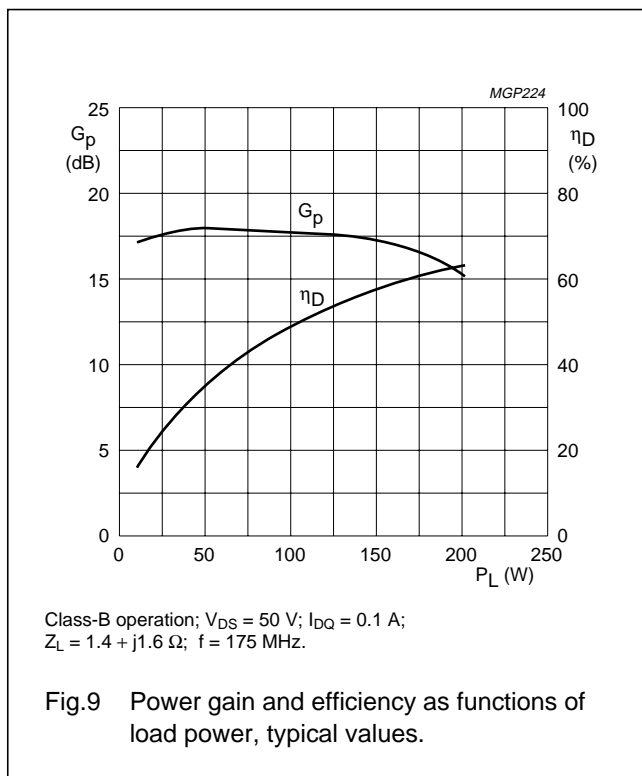

VHF power MOS transistor

BLF277

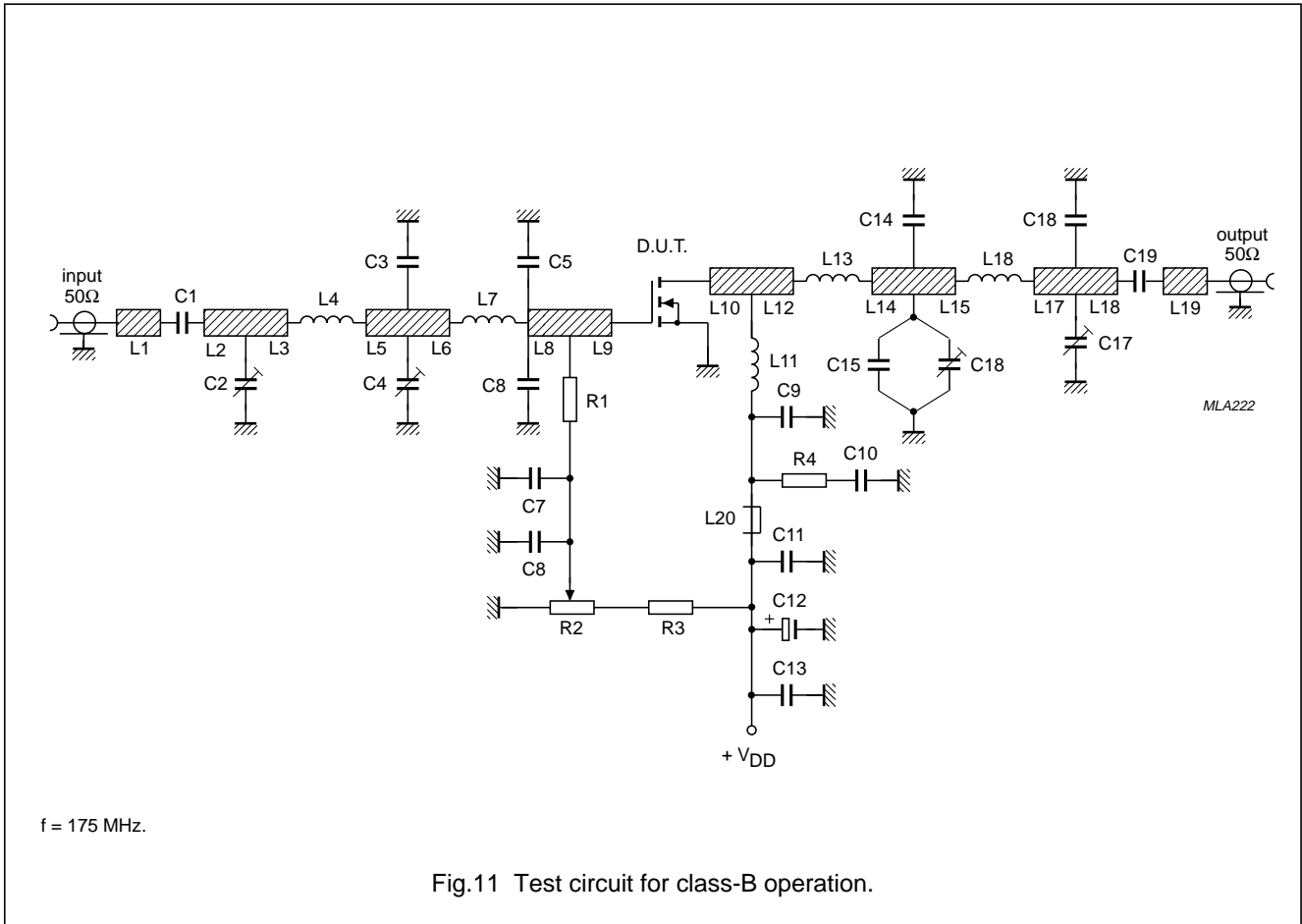

## VHF power MOS transistor

BLF277

## List of components (class-B test circuit)

COMPONENT	DESCRIPTION	VALUE	DIMENSIONS	CATALOGUE NO.
C1, C8, C19	multilayer ceramic chip capacitor (note 1)	680 pF		
C2, C4, C17	film dielectric trimmer	5 to 60 pF		2222 809 08003
C3	multilayer ceramic chip capacitor (note 1)	33 pF		
C5, C6, C9	multilayer ceramic chip capacitor (note 1)	100 pF		
C7, C10, C13	multilayer ceramic chip capacitor	100 nF		2222 852 47104
C11	multilayer ceramic chip capacitor	10 nF		2222 852 47103
C12	electrolytic capacitor	10 $\mu$ F, 63 V		
C14, C15	multilayer ceramic chip capacitor (note 2)	3 $\times$ 22 pF in parallel		
C16	film dielectric trimmer	4 to 40 pF		2222 809 08002
C18	multilayer ceramic chip capacitor (note 1)	18 pF		
L1	stripline (note 3)	49 $\Omega$	length 8 mm width 4 mm	
L2	stripline (note 3)	49 $\Omega$	length 12 mm width 4 mm	
L3	stripline (note 3)	49 $\Omega$	length 7.5 mm width 4 mm	
L4	2 turns enamelled 1.5 mm copper wire	25 nH	length 3.7 mm int. dia. 5 mm leads 2 $\times$ 1 mm	
L5	stripline (note 3)	49 $\Omega$	length 15.5 mm width 4 mm	
L6	stripline (note 3)	49 $\Omega$	length 5 mm width 4 mm	
L7	2 turns enamelled 1.5 mm copper wire	25 nH	length 4.2 mm int. dia. 5 mm leads 2 $\times$ 4 mm	
L8	stripline (note 3)	31 $\Omega$	length 18 mm width 6 mm	
L9	stripline (note 3)	31 $\Omega$	length 6 mm width 6 mm	
L10, L12	stripline (note 3)	31 $\Omega$	length 7 mm width 6 mm	
L11	3 turns enamelled 1.5 mm copper wire	40 nH	length 6.8 mm int. dia. 5 mm leads 2 $\times$ 3 mm	
L13	1 turn enamelled 1.5 mm copper wire	3 nH	int. dia. 2.8 mm leads 2 $\times$ 1 mm	
L14	stripline (note 3)	36 $\Omega$	length 15.5 mm width 5 mm	



## VHF power MOS transistor

BLF277

COMPONENT	DESCRIPTION	VALUE	DIMENSIONS	CATALOGUE NO.
L15	stripline (note 3)	36 $\Omega$	length 8 mm width 5 mm	
L16	2 turns enamelled 2.5 mm copper wire	28 nH	length 5.5 mm int. dia. 5 mm leads 2 $\times$ 3 mm	
L17	stripline (note 3)	36 $\Omega$	length 12 mm width 5 mm	
L18, L19	stripline (note 3)	36 $\Omega$	length 8.5 mm width 5 mm	
L20	grade 3B Ferroxcube RF choke			4312 020 36642
R1	0.4 W metal film resistor	16 $\Omega$		
R2	10 turn potentiometer	50 k $\Omega$		
R3	0.4 W metal film resistor	400 k $\Omega$		
R4	0.4 W metal film resistor	100 k $\Omega$		

**Notes**

1. American Technical Ceramics (ATC) capacitor, type 100B or other capacitor of the same quality.
2. American Technical Ceramics (ATC) capacitor, type 175B or other capacitor of the same quality.
3. The striplines are mounted double copper-clad printed circuit board, with epoxy glass dielectric ( $\epsilon_r = 4.5$ ); thickness 1.6 mm.

VHF power MOS transistor

BLF277

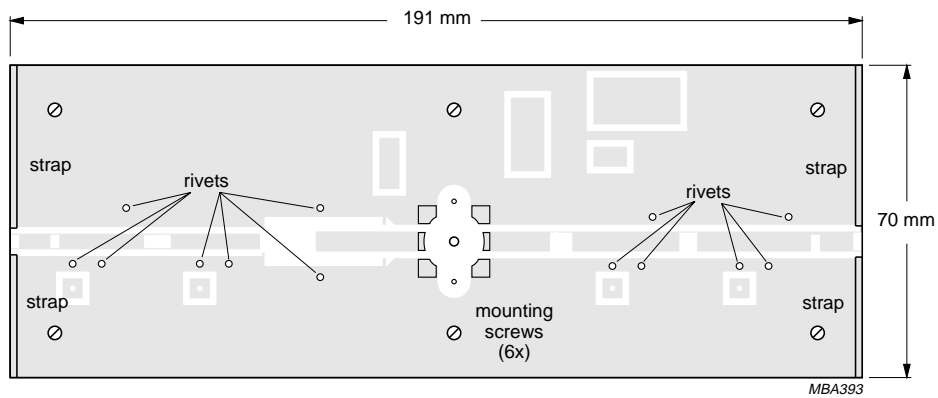
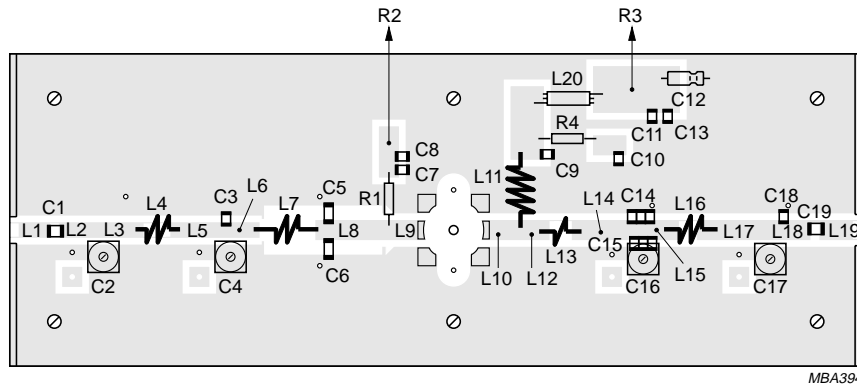

The circuit and components are situated on one side of the printed circuit board, the other side being fully metallized, to serve as a ground plane. Earth connections are made by means of copper straps and hollow rivets.

Fig.12 Component layout for 175 MHz class-B test circuit.

VHF power MOS transistor

BLF277

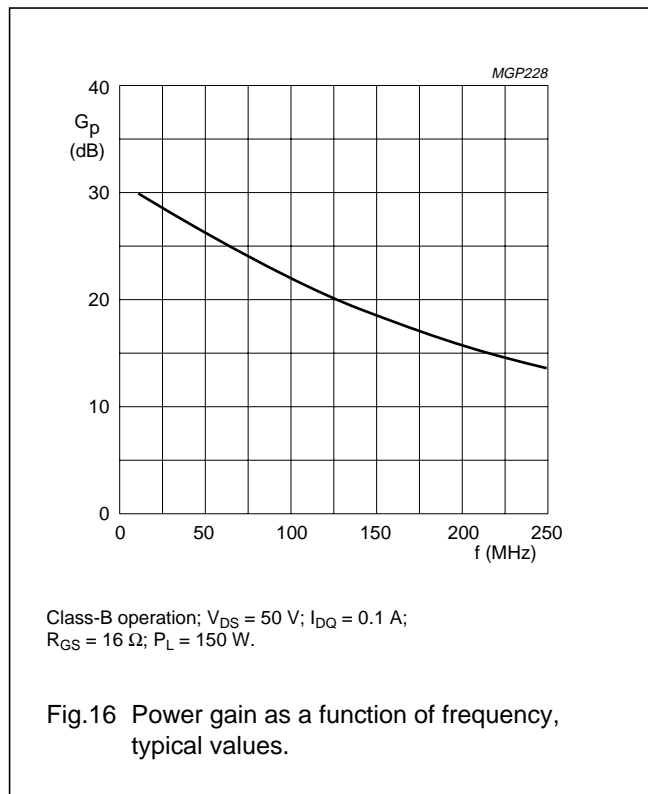
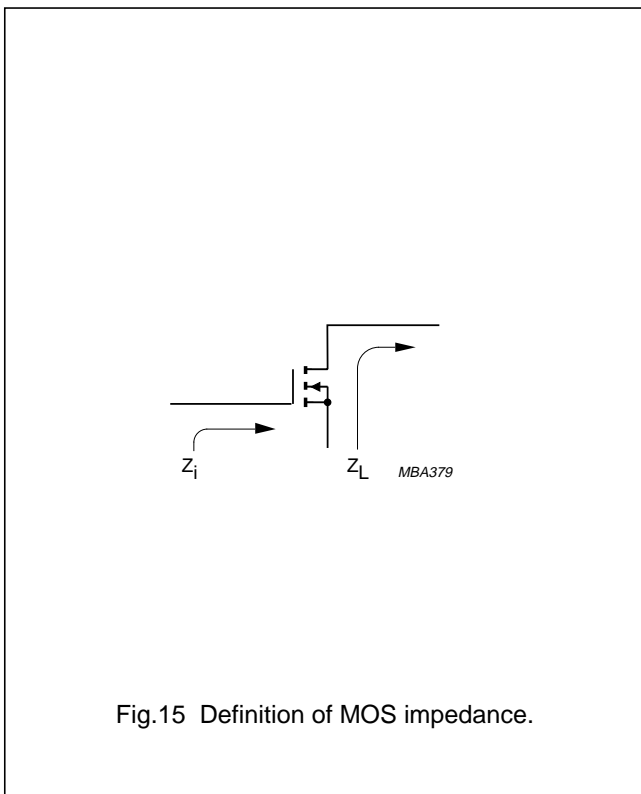
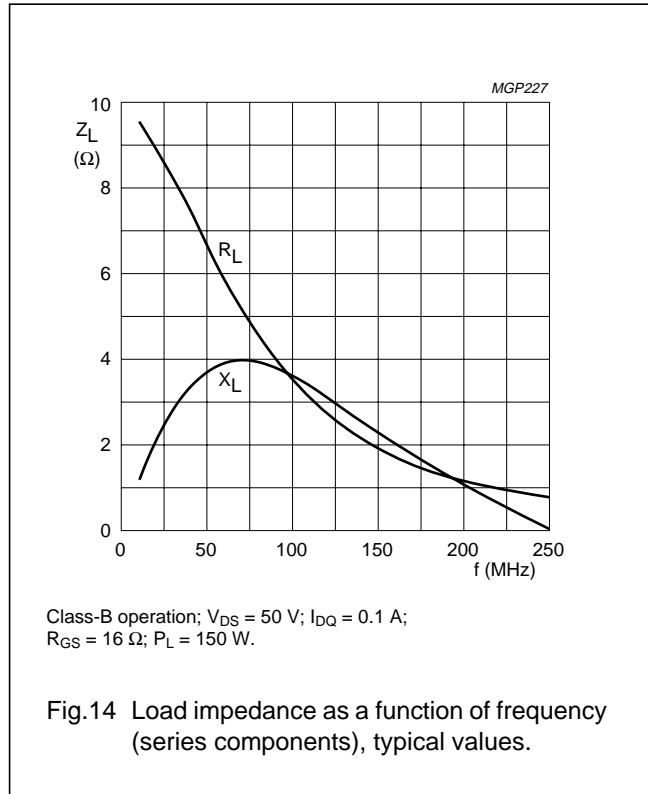
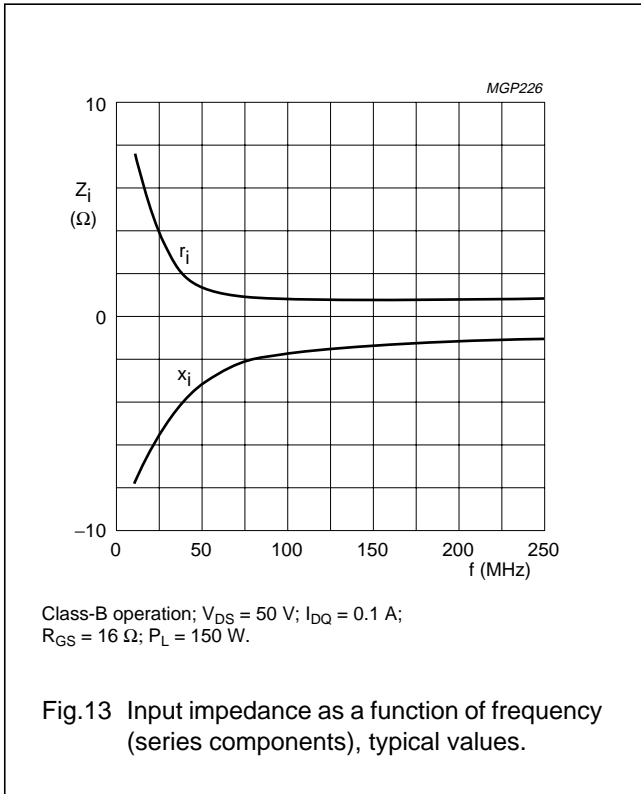



## VHF power MOS transistor

BLF277

**DEFINITIONS**

<b>Data Sheet Status</b>	
Objective specification	This data sheet contains target or goal specifications for product development.
Preliminary specification	This data sheet contains preliminary data; supplementary data may be published later.
Product specification	This data sheet contains final product specifications.
<b>Limiting values</b>	
Limiting values given are in accordance with the Absolute Maximum Rating System (IEC 134). Stress above one or more of the limiting values may cause permanent damage to the device. These are stress ratings only and operation of the device at these or at any other conditions above those given in the Characteristics sections of the specification is not implied. Exposure to limiting values for extended periods may affect device reliability.	
<b>Application information</b>	
Where application information is given, it is advisory and does not form part of the specification.	

**LIFE SUPPORT APPLICATIONS**

These products are not designed for use in life support appliances, devices, or systems where malfunction of these products can reasonably be expected to result in personal injury. Philips customers using or selling these products for use in such applications do so at their own risk and agree to fully indemnify Philips for any damages resulting from such improper use or sale.