

DATA SHEET

BLF522 UHF power MOS transistor

Product specification

September 1992

UHF power MOS transistor

BLF522

FEATURES

- High power gain
- Easy power control
- Gold metallization
- Good thermal stability
- Withstands full load mismatch
- Designed for broadband operation.

DESCRIPTION

Silicon N-channel enhancement mode vertical D-MOS transistor designed for communications transmitter applications in the UHF frequency range.

The transistor is encapsulated in a 6-lead, SOT171 flange envelope, with a ceramic cap. All leads are isolated from the flange.

PINNING - SOT171

PIN	DESCRIPTION
1	source
2	source
3	gate
4	drain
5	source
6	source

PIN CONFIGURATION

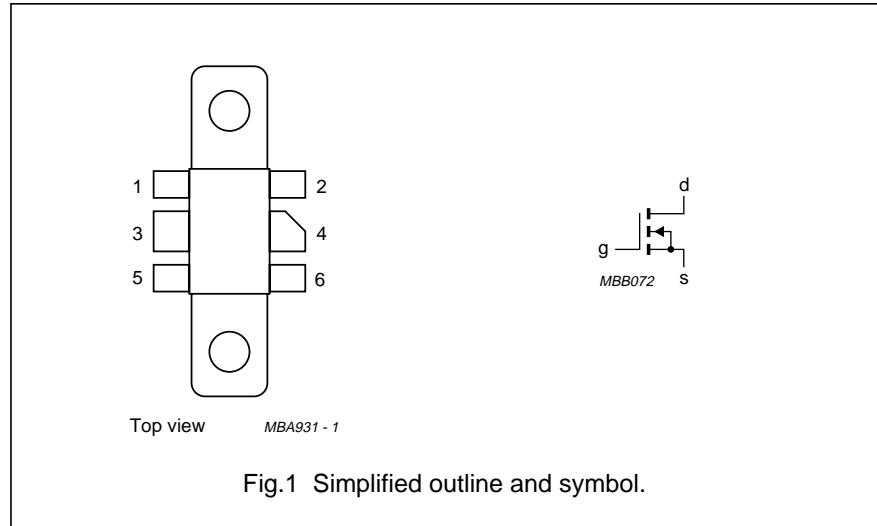

CAUTION

The device is supplied in an antistatic package. The gate-source input must be protected against static charge during transport and handling.

WARNING

Product and environmental safety - toxic materials

This product contains beryllium oxide. The product is entirely safe provided that the BeO disc is not damaged. All persons who handle, use or dispose of this product should be aware of its nature and of the necessary safety precautions. After use, dispose of as chemical or special waste according to the regulations applying at the location of the user. It must never be thrown out with the general or domestic waste.

QUICK REFERENCE DATA

RF performance at $T_h = 25\text{ }^\circ\text{C}$ in a common source class-B circuit.

MODE OF OPERATION	f (MHz)	V _{DS} (V)	P _L (W)	GP (dB)	η_D (%)
CW, class-B	500	12.5	5	> 10	> 50

UHF power MOS transistor

BLF522

LIMITING VALUES

In accordance with the Absolute Maximum System (IEC 134).

SYMBOL	PARAMETER	CONDITIONS	MIN.	MAX.	UNIT
V_{DS}	drain-source voltage		–	40	V
$\pm V_{GS}$	gate-source voltage		–	20	V
I_D	DC drain current		–	1.8	A
P_{tot}	total power dissipation	up to $T_{mb} = 25\text{ °C}$	–	20	W
T_{stg}	storage temperature		–65	150	°C
T_i	junction temperature		–	200	°C

THERMAL RESISTANCE

SYMBOL	PARAMETER	CONDITIONS	THERMAL RESISTANCE
$R_{th\ j-mb}$	thermal resistance from junction to mounting base	$T_{mb} = 25\text{ °C}; P_{tot} = 20\text{ W}$	8.8 K/W
$R_{th\ mb-h}$	thermal resistance from mounting base to heatsink	$T_{mb} = 25\text{ °C}; P_{tot} = 20\text{ W}$	0.4 K/W

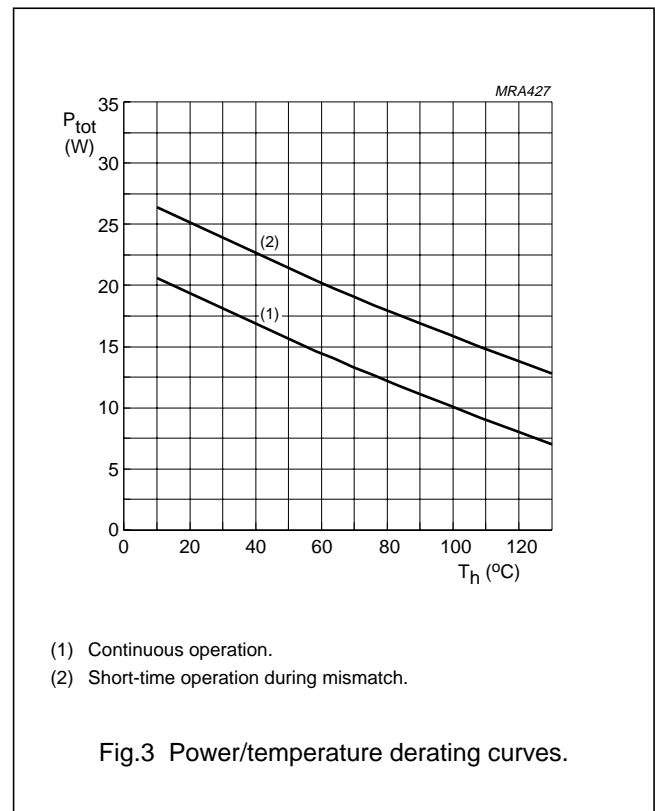
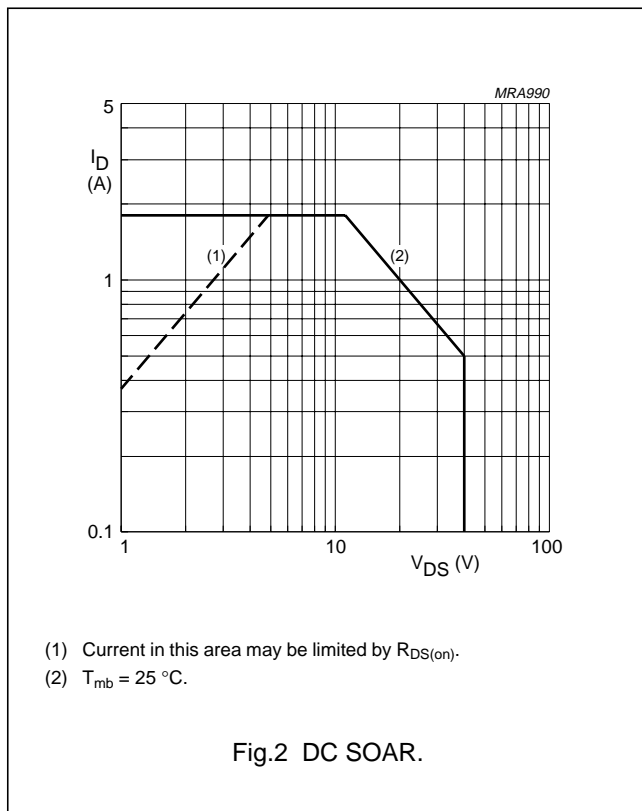

UHF power MOS transistor

BLF522

CHARACTERISTICS

$T_j = 25\text{ }^\circ\text{C}$ unless otherwise specified.

SYMBOL	PARAMETER	CONDITIONS	MIN.	TYP.	MAX.	UNIT
$V_{(BR)DSS}$	drain-source breakdown voltage	$V_{GS} = 0; I_D = 5\text{ mA}$	40	–	–	V
I_{DSS}	drain-source leakage current	$V_{GS} = 0; V_{DS} = 12.5\text{ V}$	–	–	0.5	mA
I_{GSS}	gate-source leakage current	$\pm V_{GS} = 20\text{ V}; V_{DS} = 0$	–	–	1	μA
$V_{GS(th)}$	gate-source threshold voltage	$I_D = 50\text{ mA}; V_{DS} = 10\text{ V}$	2	–	4.5	V
g_{fs}	forward transconductance	$I_D = 0.7\text{ A}; V_{DS} = 10\text{ V}$	200	270	–	mS
$R_{DS(on)}$	drain-source on-state resistance	$I_D = 0.7\text{ A}; V_{GS} = 15\text{ V}$	–	1.8	2.7	Ω
I_{DSX}	on-state drain current	$V_{GS} = 15\text{ V}; V_{DS} = 10\text{ V}$	–	2.3	–	A
C_{is}	input capacitance	$V_{GS} = 0; V_{DS} = 12.5\text{ V}; f = 1\text{ MHz}$	–	14	–	pF
C_{os}	output capacitance	$V_{GS} = 0; V_{DS} = 12.5\text{ V}; f = 1\text{ MHz}$	–	17	–	pF
C_{rs}	feedback capacitance	$V_{GS} = 0; V_{DS} = 12.5\text{ V}; f = 1\text{ MHz}$	–	3	–	pF

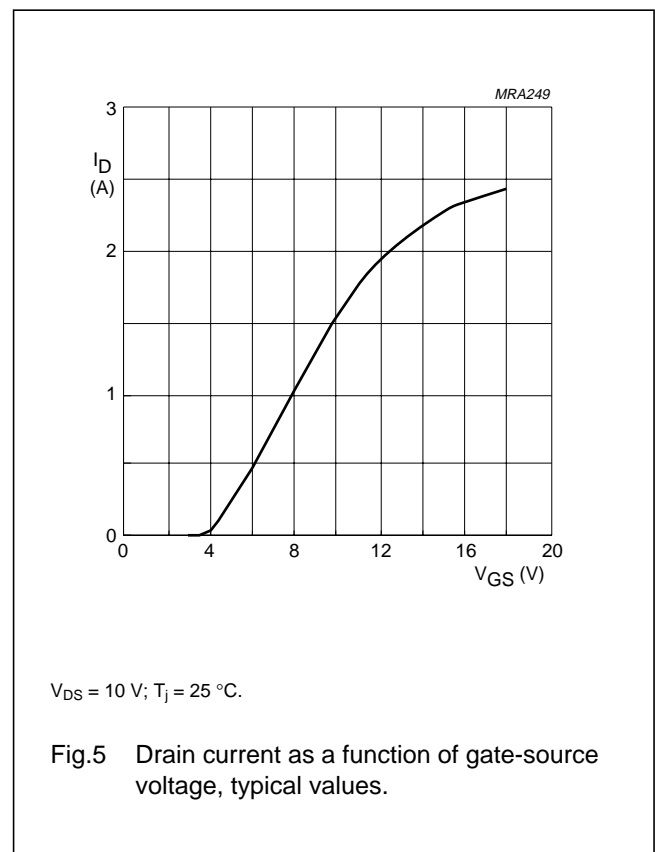
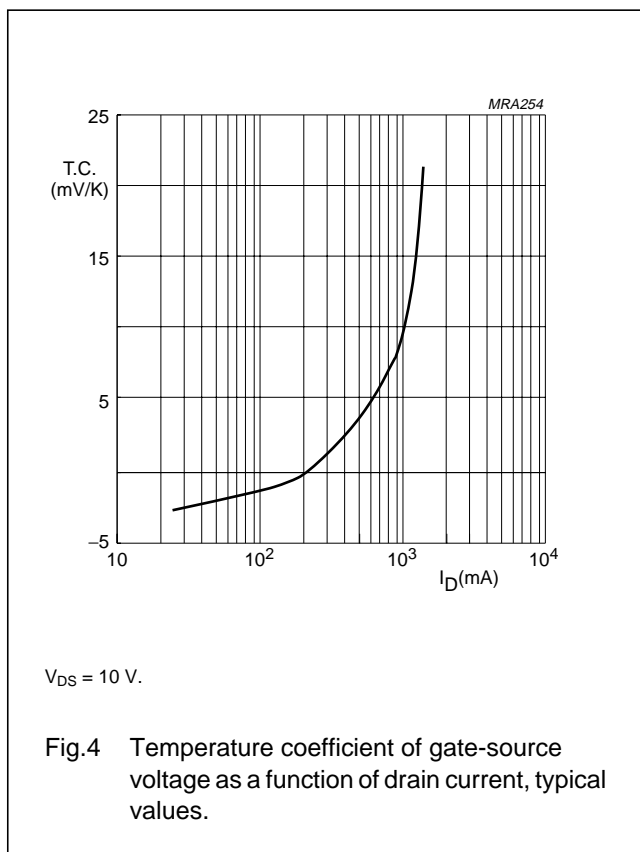

UHF power MOS transistor

BLF522

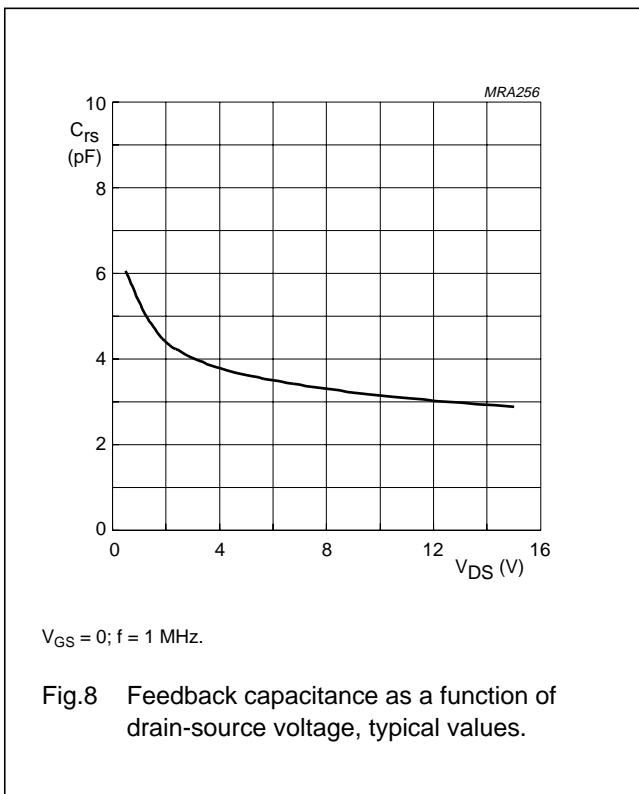
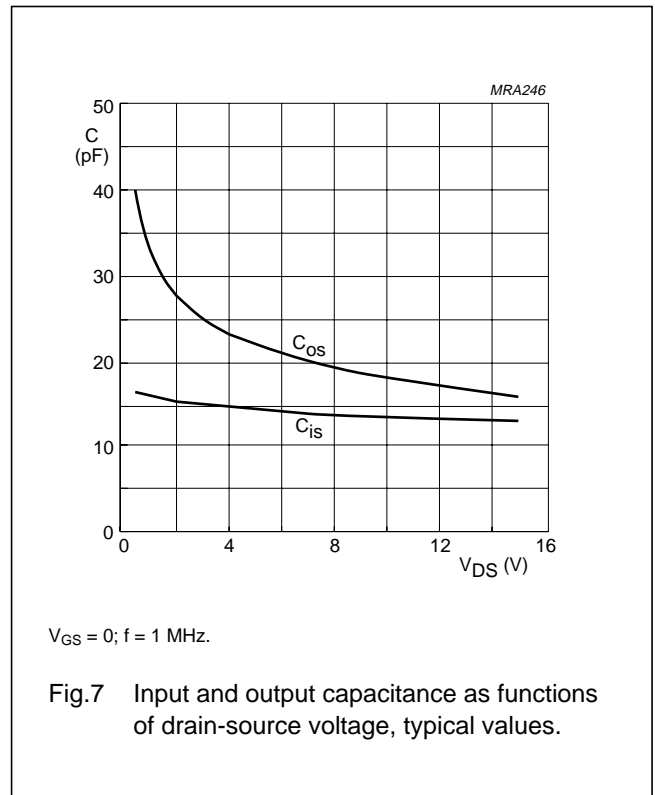
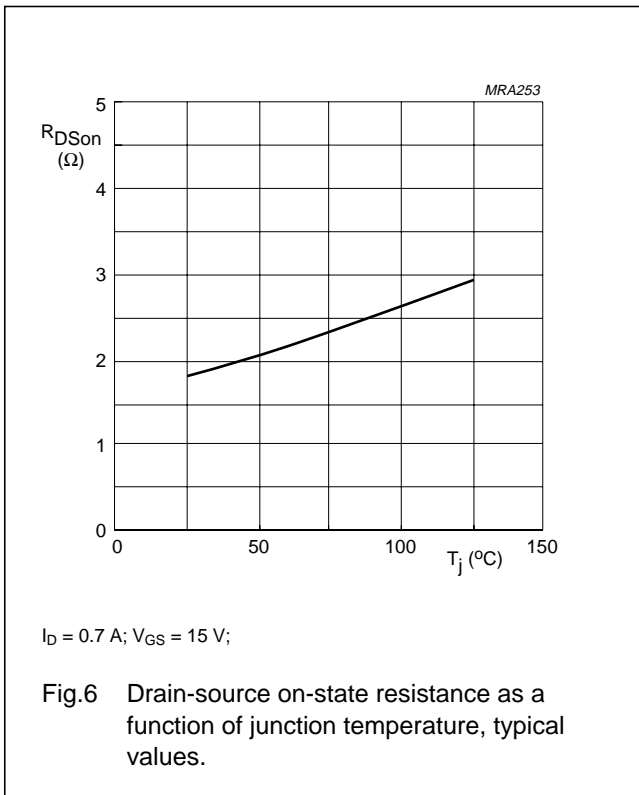

UHF power MOS transistor

BLF522

APPLICATION INFORMATION FOR CLASS-B OPERATION

$T_h = 25\text{ }^\circ\text{C}$; $R_{th\text{ mb-h}} = 0.4\text{ K/W}$, unless otherwise specified.

RF performance in a common source class-B circuit.

MODE OF OPERATION	f (MHz)	V _{DS} (V)	I _{DQ} (mA)	P _L (W)	G _p (dB)	η _D (%)
CW, class-B	500	12.5	50	5	> 10 typ. 11	> 50 typ. 55

Ruggedness in class-B operation

The BLF522 is capable of withstanding a full load mismatch corresponding to VSWR = 50:1 through all phases under the following conditions:

V_{DS} = 15.5 V; f = 500 MHz at rated output power.

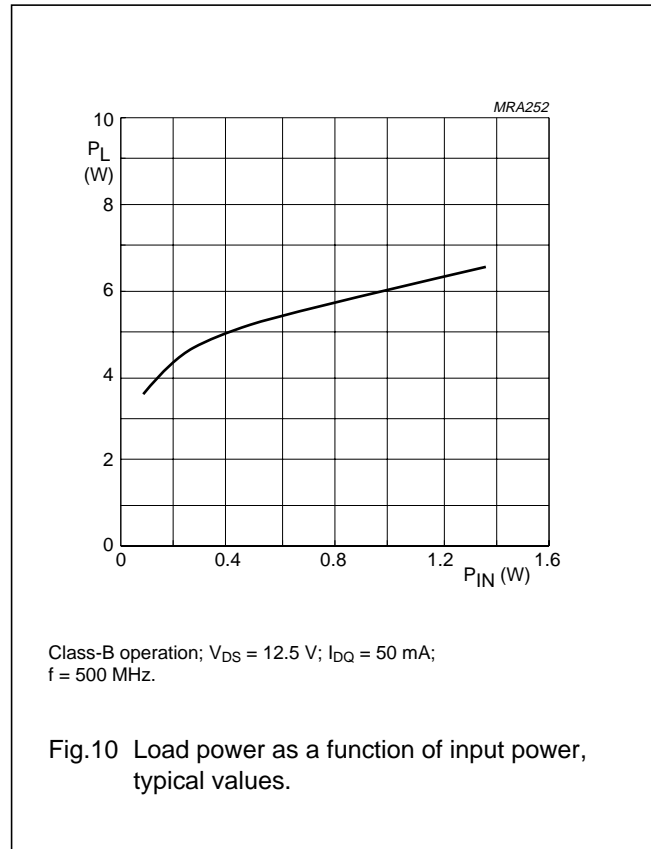
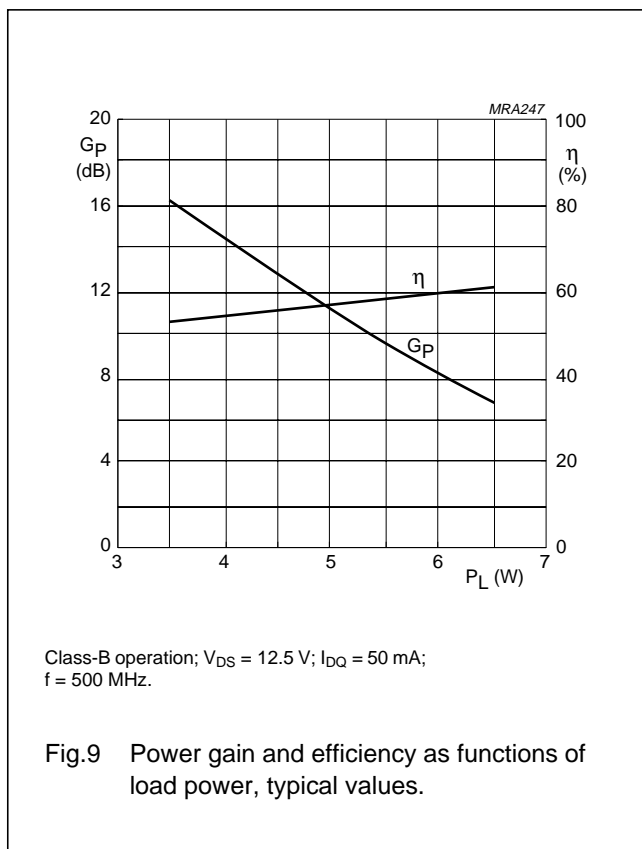

UHF power MOS transistor

BLF522

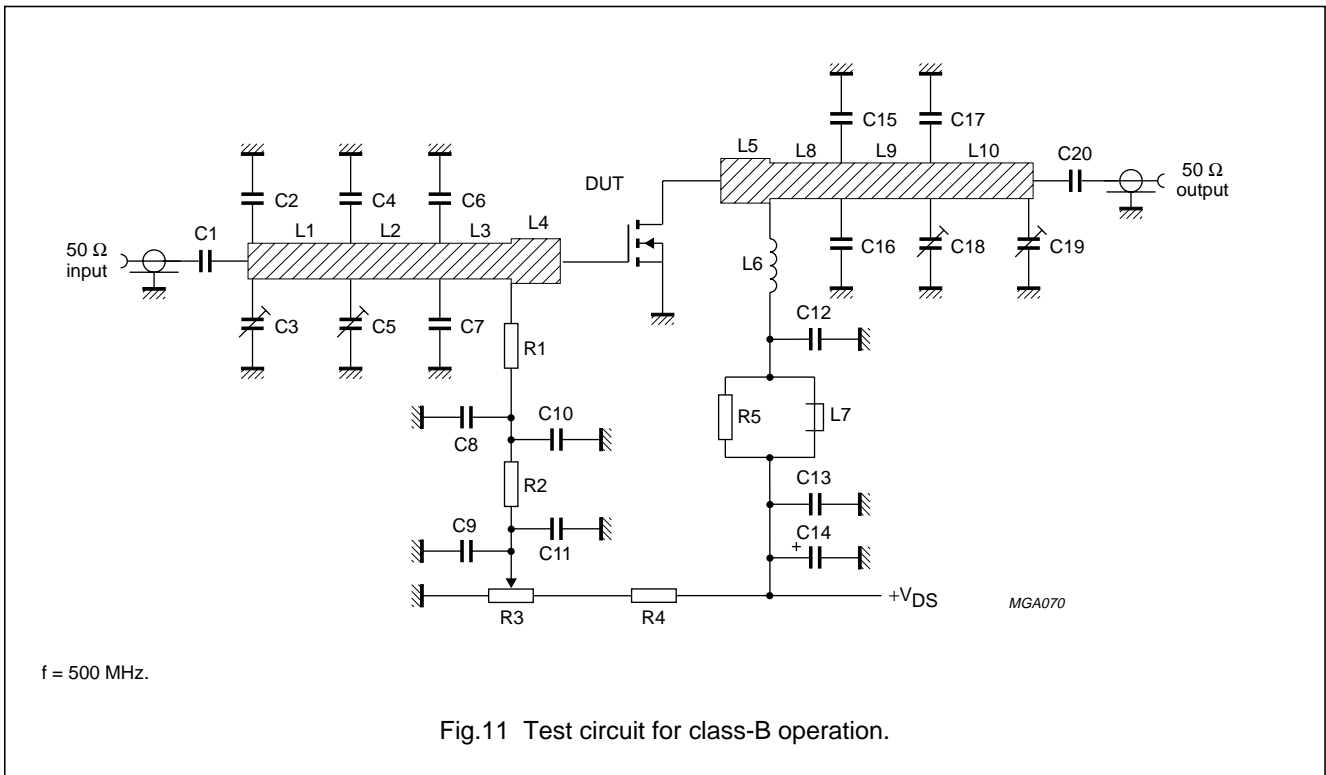

Fig.11 Test circuit for class-B operation.

UHF power MOS transistor

BLF522

List of components (class-B test circuit)

COMPONENT	DESCRIPTION	VALUE	DIMENSIONS	CATALOGUE NO.
C1, C8, C20	multilayer ceramic chip capacitor (note 1)	430 pF, 50 V		
C2	multilayer ceramic chip capacitor (note 2)	3.9 pF, 50 V		
C3, C5, C18, C19	film dielectric trimmer	2 to 18 pF		2222 809 09003
C4	multilayer ceramic chip capacitor (note 2)	20 pF, 50 V		
C6, C7, C15, C16, C17	multilayer ceramic chip capacitor (note 2)	10 pF, 50 V		
C9, C10, C11, C13	multilayer ceramic chip capacitor	100 nF, 50 V		2222 852 47104
C12	multilayer ceramic chip capacitor (note 1)	390 pF, 50 V		
C14	electrolytic capacitor	10 μ F, 63 V		2222 030 38109
L1	stripline (note 3)	50 Ω	36.6 \times 2.5 mm	
L2	stripline (note 3)	50 Ω	16.7 \times 2.5 mm	
L3	stripline (note 3)	50 Ω	7.7 \times 2.5 mm	
L4, L5	stripline (note 3)	42 Ω	3 \times 3 mm	
L6	4 turns enamelled 0.8 mm copper wire	24.9 nH	length 6.9 mm int. dia. 2.5 mm leads 2 \times 5 mm	
L7	grade 3B Ferroxcube RF choke			4312 020 36642
L8	stripline (note 3)	50 Ω	10 \times 2.5 mm	
L9	stripline (note 3)	50 Ω	16.5 \times 2.5 mm	
L10	stripline (note 3)	50 Ω	34.5 \times 2.5 mm	
R1	0.4 W metal film resistor	10 k Ω		2322 151 51003
R2	0.4 W metal film resistor	1 k Ω		2322 151 51002
R3	10 turns cermet potentiometer	50 k Ω		
R4	0.4 W metal film resistor	47 k Ω		2322 151 54703
R5	1 W metal film resistor	10 Ω		2322 153 51009

Notes

1. American Technical Ceramics (ATC) capacitor, type 100B or other capacitor of the same quality.
2. American Technical Ceramics (ATC) capacitor, type 100A or other capacitor of the same quality.
3. The striplines are on a double copper-clad printed circuit board, with PTFE fibre-glass dielectric ($\epsilon_r = 2.2$); thickness 0.79 mm.

UHF power MOS transistor

BLF522

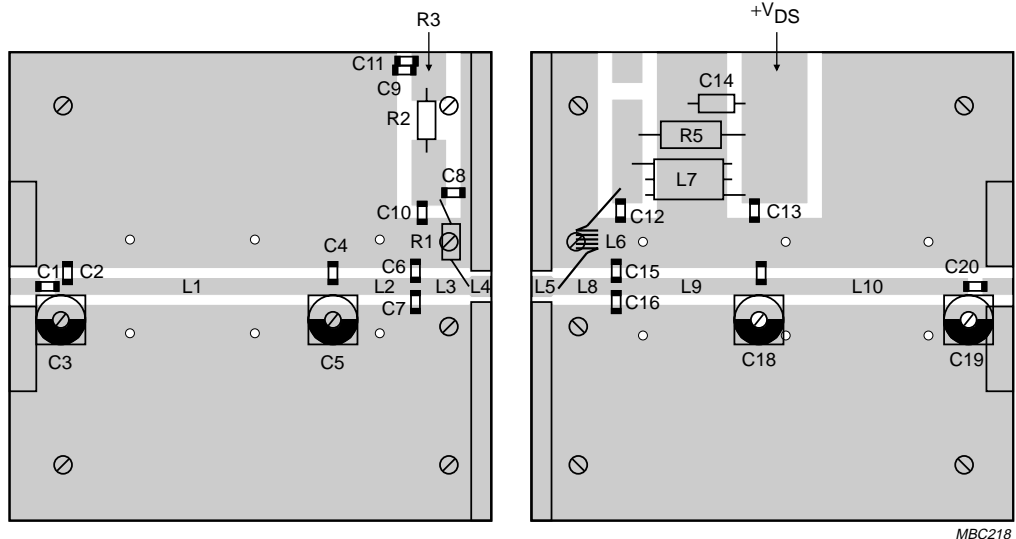

MBC218

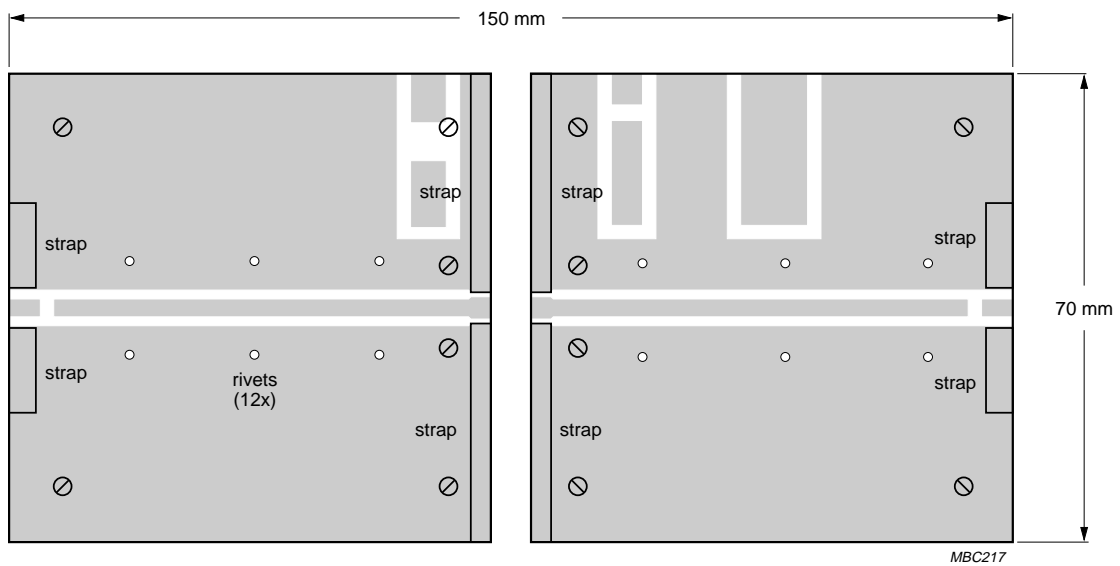

MBC217

The circuit and components are situated on one side of the printed circuit board, the other side being fully metallized, to serve as a ground plane. Earth connections are made by means of copper straps and hollow rivets for a direct contact between upper and lower sheets.

Fig.12 Component layout for 500 MHz class-B test circuit.

UHF power MOS transistor

BLF522

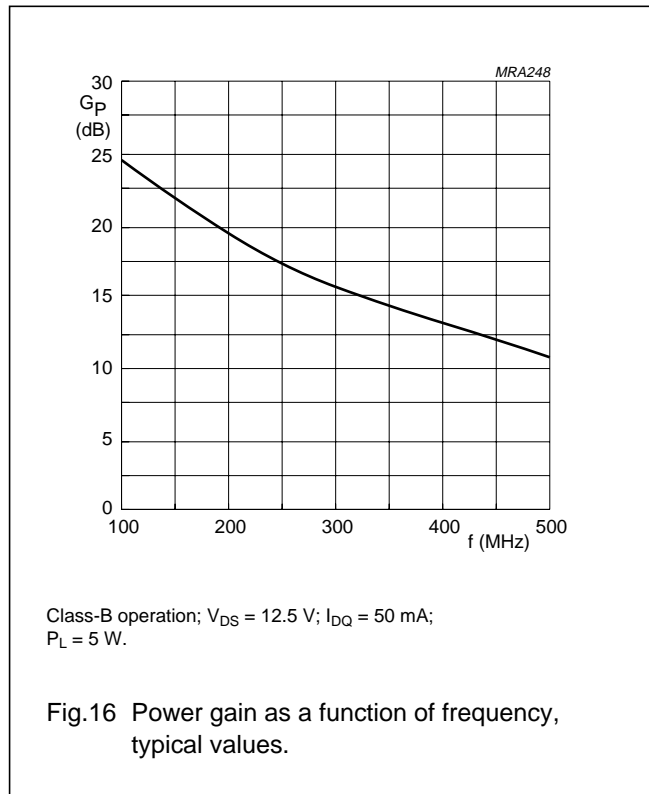
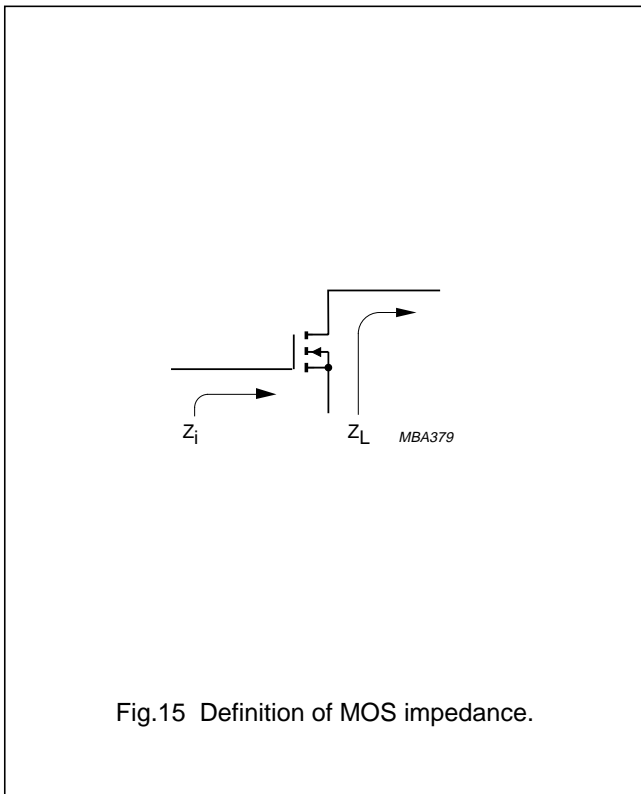
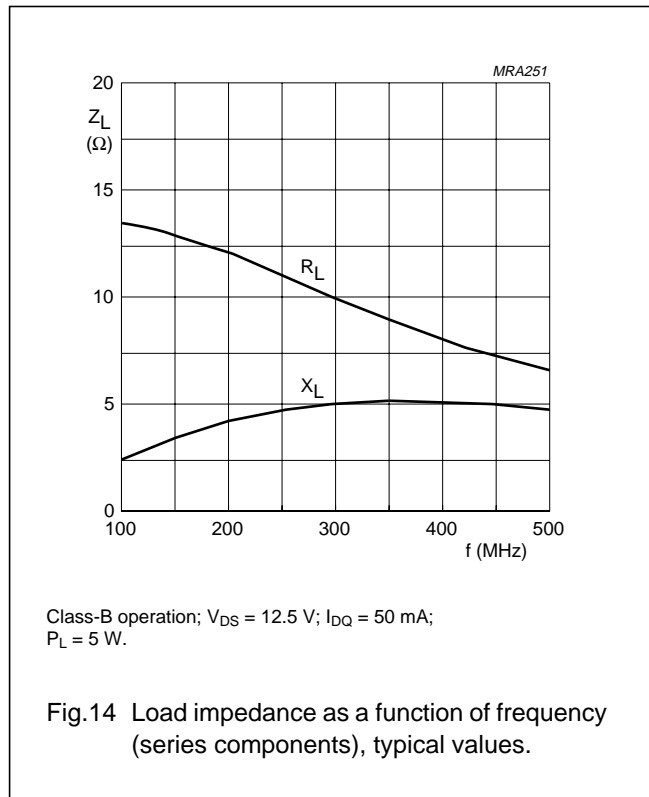
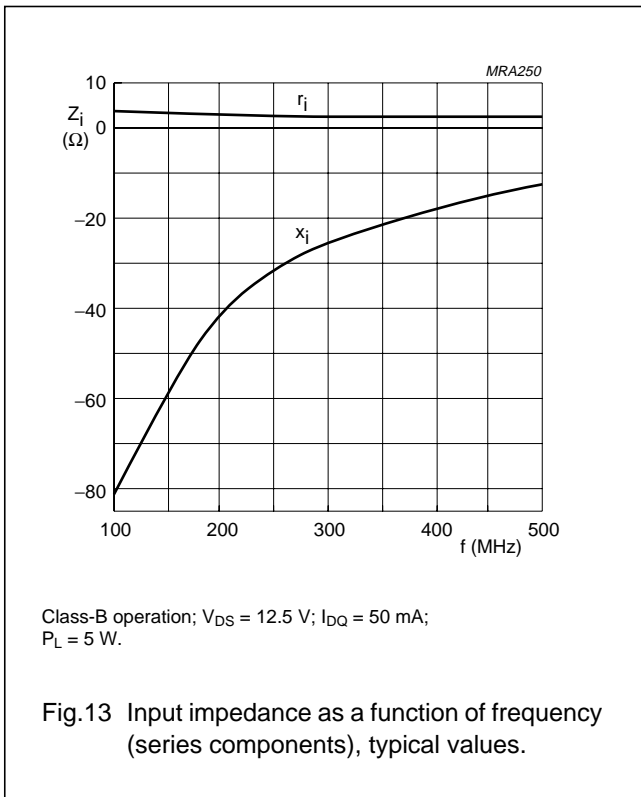

UHF power MOS transistor

BLF522

PACKAGE OUTLINE

Flanged ceramic package; 2 mounting holes; 6 leads

SOT171A

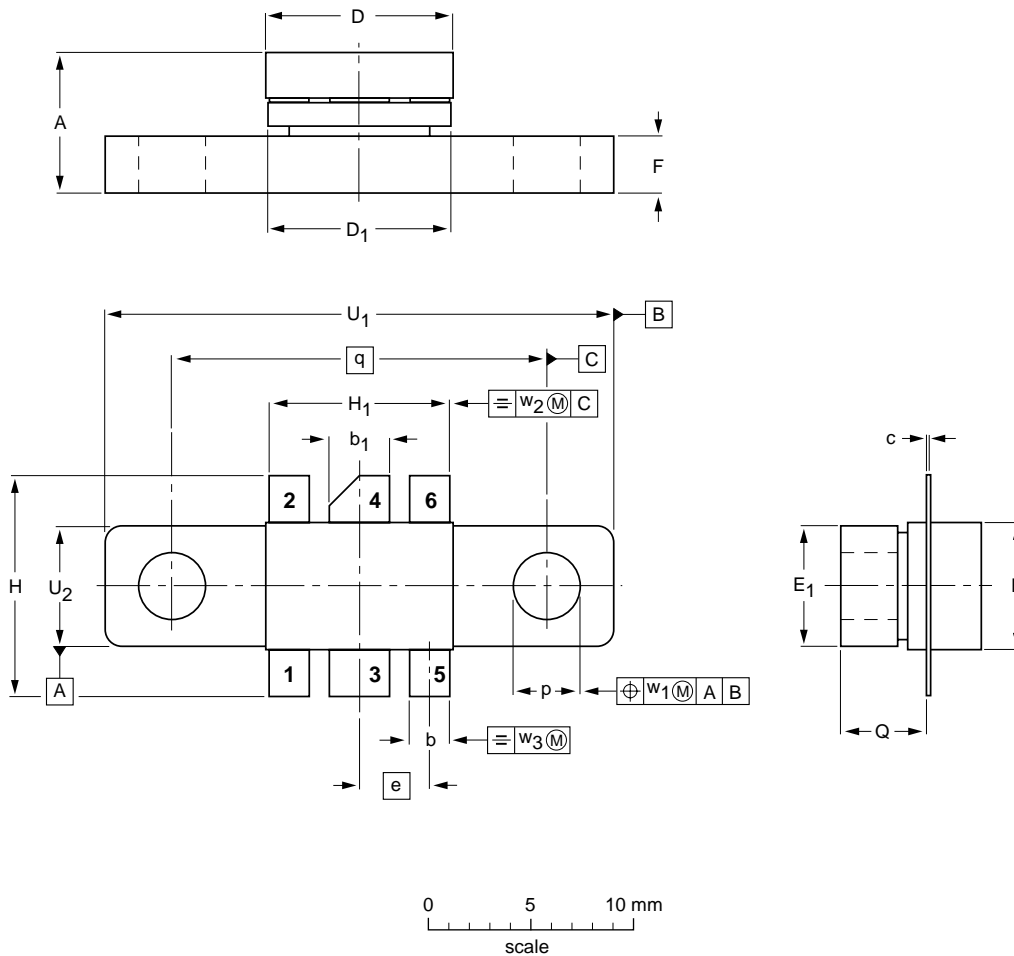

DIMENSIONS (millimetre dimensions are derived from the original inch dimensions)

UNIT	A	b	b ₁	c	D	D ₁	E	E ₁	e	F	H	H ₁	p	Q	q	U ₁	U ₂	w ₁	w ₂	w ₃
mm	6.81 6.07	2.15 1.85	3.20 2.89	0.16 0.07	9.25 9.04	9.30 8.99	5.95 5.74	6.00 5.70	3.58	3.05 2.54	11.31 10.54	9.27 9.01	3.43 3.17	4.32 4.11	18.42	24.90 24.63	6.00 5.70	0.51	1.02	0.26
inches	0.268 0.239	0.085 0.073	0.126 0.114	0.006 0.003	0.364 0.356	0.366 0.354	0.234 0.226	0.236 0.224	0.140	0.120 0.100	0.445 0.415	0.365 0.355	0.135 0.125	0.170 0.162	0.725	0.980 0.970	0.236 0.224	0.02	0.04	0.01

OUTLINE VERSION	REFERENCES				EUROPEAN PROJECTION	ISSUE DATE
	IEC	JEDEC	EIAJ			
SOT171A						97-06-28

UHF power MOS transistor

BLF522

DEFINITIONS

Data Sheet Status	
Objective specification	This data sheet contains target or goal specifications for product development.
Preliminary specification	This data sheet contains preliminary data; supplementary data may be published later.
Product specification	This data sheet contains final product specifications.
Limiting values	
Limiting values given are in accordance with the Absolute Maximum Rating System (IEC 134). Stress above one or more of the limiting values may cause permanent damage to the device. These are stress ratings only and operation of the device at these or at any other conditions above those given in the Characteristics sections of the specification is not implied. Exposure to limiting values for extended periods may affect device reliability.	
Application information	
Where application information is given, it is advisory and does not form part of the specification.	

LIFE SUPPORT APPLICATIONS

These products are not designed for use in life support appliances, devices, or systems where malfunction of these products can reasonably be expected to result in personal injury. Philips customers using or selling these products for use in such applications do so at their own risk and agree to fully indemnify Philips for any damages resulting from such improper use or sale.