

DATA SHEET

BLF544B UHF push-pull power MOS transistor

Product specification

October 1992

UHF push-pull power MOS transistor

BLF544B

FEATURES

- High power gain
- Easy power control
- Good thermal stability
- Gold metallization ensures excellent reliability
- Designed for broadband operation.

DESCRIPTION

Silicon N-channel enhancement mode vertical D-MOS push-pull transistor designed for communications transmitter applications in the UHF frequency range.

The transistor is encapsulated in a 4-lead, SOT268 balanced flange envelope, with two ceramic caps. The mounting flange provides the common source connection for the transistors.

PIN CONFIGURATION

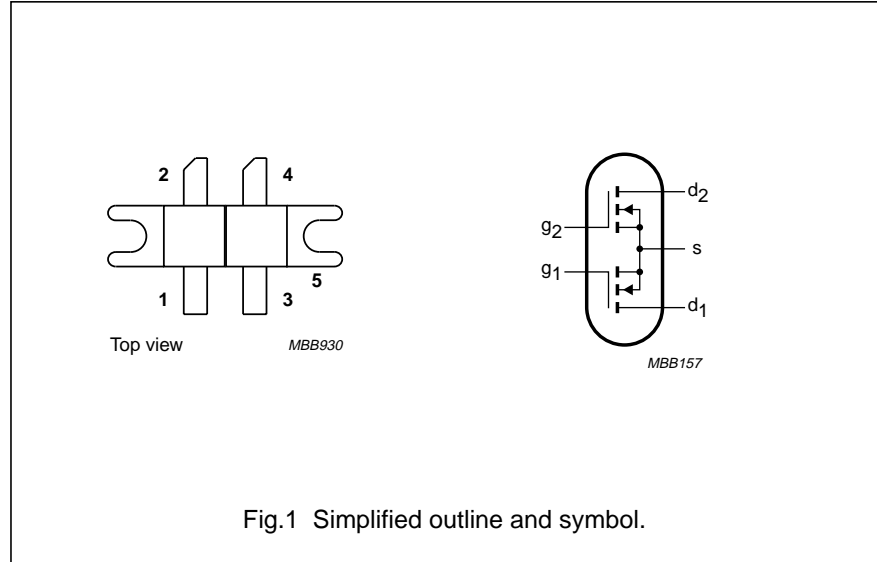

Fig.1 Simplified outline and symbol.

CAUTION

The device is supplied in an antistatic package. The gate-source input must be protected against static charge during transport and handling.

PINNING - SOT268

PIN	DESCRIPTION
1	gate 1
2	drain 1
3	gate 2
4	drain 2
5	source

WARNING

Product and environmental safety - toxic materials

This product contains beryllium oxide. The product is entirely safe provided that the BeO discs are not damaged. All persons who handle, use or dispose of this product should be aware of its nature and of the necessary safety precautions. After use, dispose of as chemical or special waste according to the regulations applying at the location of the user. It must never be thrown out with the general or domestic waste.

QUICK REFERENCE DATA

RF performance at $T_h = 25\text{ }^\circ\text{C}$ in a push-pull common source test circuit.

MODE OF OPERATION	f (MHz)	V _{DS} (V)	P _L (W)	G _p (dB)	η _D (%)
CW, class-B	500	28	20	> 12	> 50

UHF push-pull power MOS transistor

BLF544B

LIMITING VALUES

In accordance with the Absolute Maximum System (IEC 134).

Per transistor section unless otherwise specified.

SYMBOL	PARAMETER	CONDITIONS	MIN.	MAX.	UNIT
V_{DS}	drain-source voltage		–	65	V
$\pm V_{GS}$	gate-source voltage		–	20	V
I_D	DC drain current		–	2	A
P_{tot}	total power dissipation	up to $T_{mb} = 25\text{ }^\circ\text{C}$; total device; both sections equally loaded	–	48	W
T_{stg}	storage temperature		–65	150	$^\circ\text{C}$
T_j	junction temperature		–	200	$^\circ\text{C}$

THERMAL RESISTANCE

SYMBOL	PARAMETER	CONDITIONS	THERMAL RESISTANCE
$R_{th\ j-mb}$	thermal resistance from junction to mounting base	total device; both sections equally loaded	3.7 K/W
$R_{th\ mb-h}$	thermal resistance from mounting base to heatsink	total device; both sections equally loaded	0.25 K/W

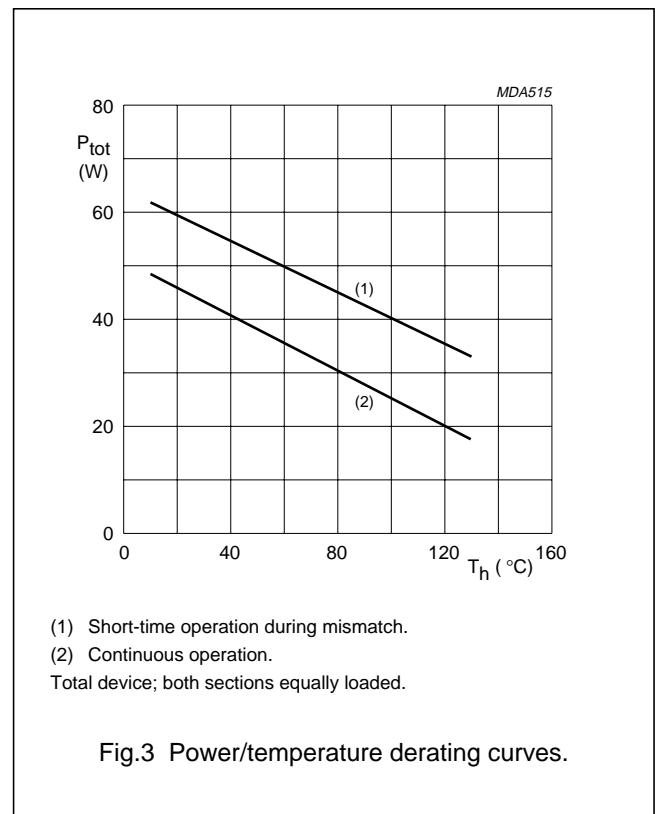
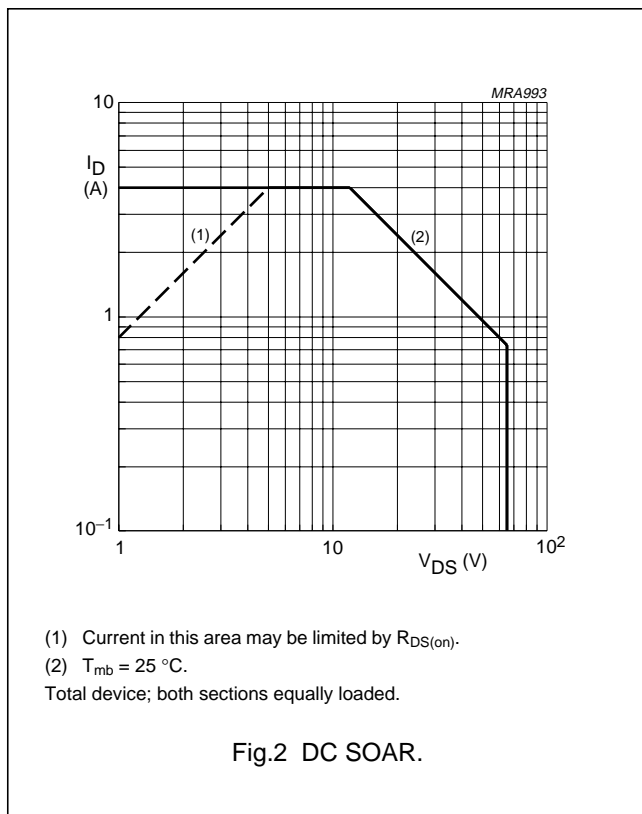

UHF push-pull power MOS transistor

BLF544B

CHARACTERISTICS (per section)

$T_j = 25\text{ }^\circ\text{C}$ unless otherwise specified.

SYMBOL	PARAMETER	CONDITIONS	MIN.	TYP.	MAX.	UNIT
$V_{(BR)DSS}$	drain-source breakdown voltage	$I_D = 5\text{ mA}; V_{GS} = 0$	65	–	–	V
I_{DSS}	drain-source leakage current	$V_{GS} = 0; V_{DS} = 28\text{ V}$	–	–	0.5	mA
I_{GSS}	gate-source leakage current	$\pm V_{GS} = 20\text{ V}; V_{DS} = 0$	–	–	1	μA
$V_{GS(th)}$	gate-source threshold voltage	$I_D = 20\text{ mA}; V_{DS} = 10\text{ V}$	1	–	4	V
g_{fs}	forward transconductance	$I_D = 0.6\text{ A}; V_{DS} = 10\text{ V}$	300	450	–	mS
$R_{DS(on)}$	drain-source on-state resistance	$I_D = 0.6\text{ A}; V_{GS} = 10\text{ V}$	–	0.7	2.5	Ω
I_{DSX}	on-state drain current	$V_{GS} = 15\text{ V}; V_{DS} = 10\text{ V}$	–	2.4	–	A
C_{is}	input capacitance	$V_{GS} = 0; V_{DS} = 28\text{ V}; f = 1\text{ MHz}$	–	16	–	pF
C_{os}	output capacitance	$V_{GS} = 0; V_{DS} = 28\text{ V}; f = 1\text{ MHz}$	–	12	–	pF
C_{rs}	feedback capacitance	$V_{GS} = 0; V_{DS} = 28\text{ V}; f = 1\text{ MHz}$	–	3.2	–	pF

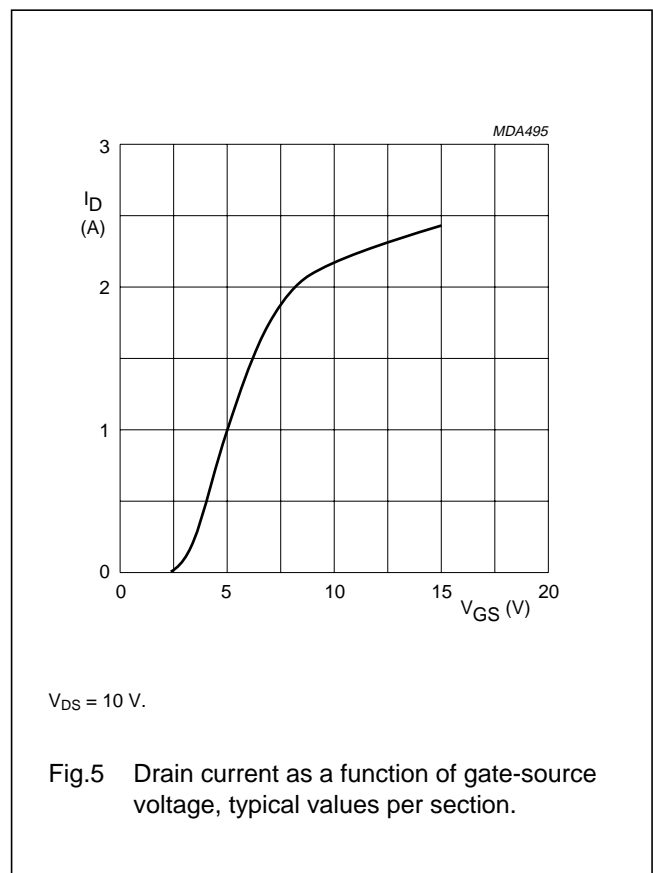
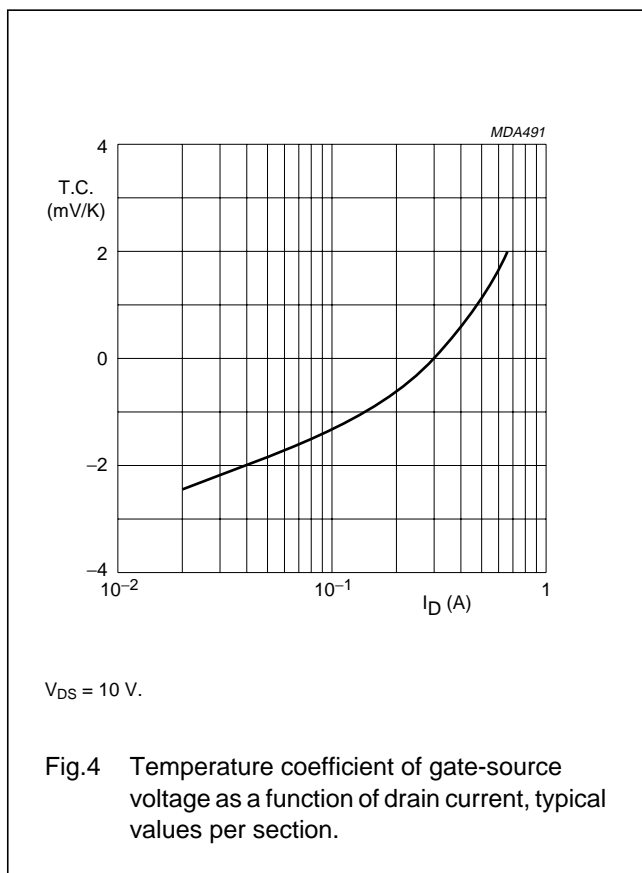

UHF push-pull power MOS transistor

BLF544B

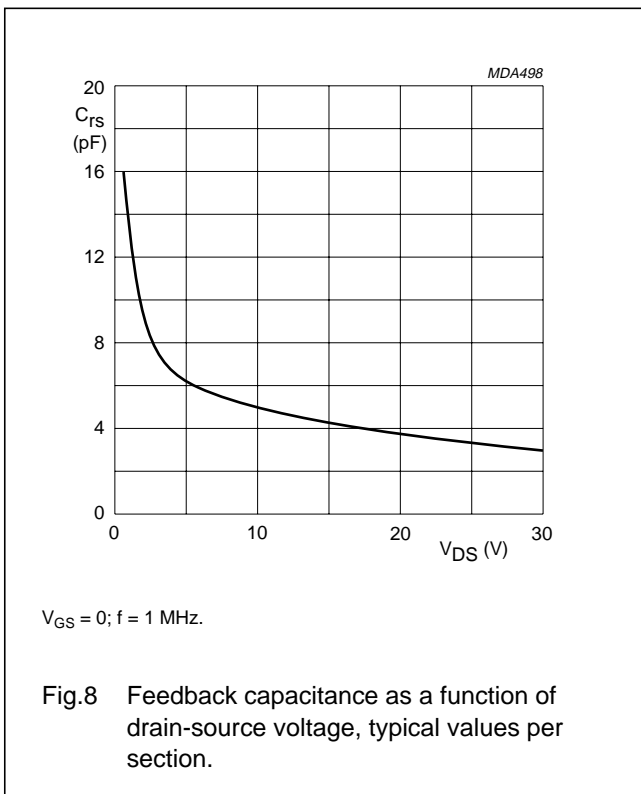
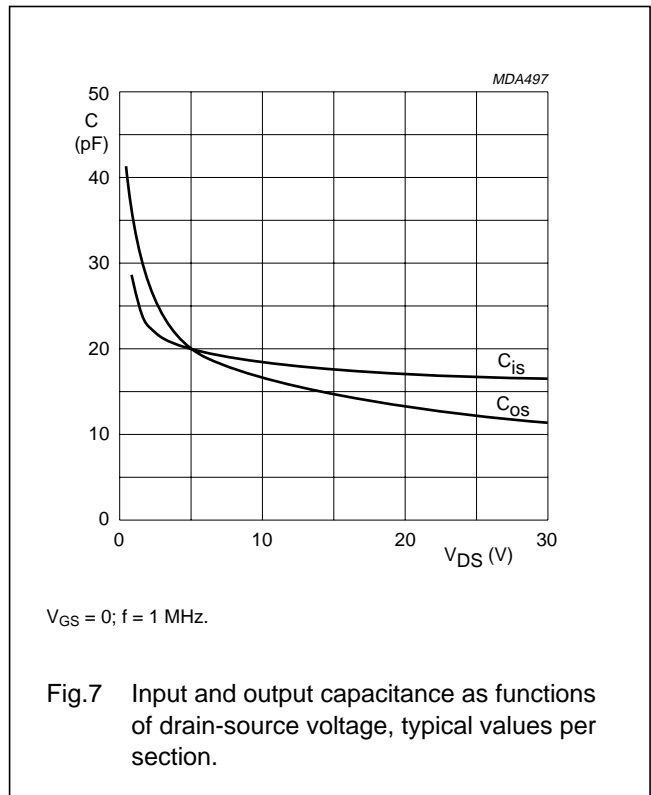
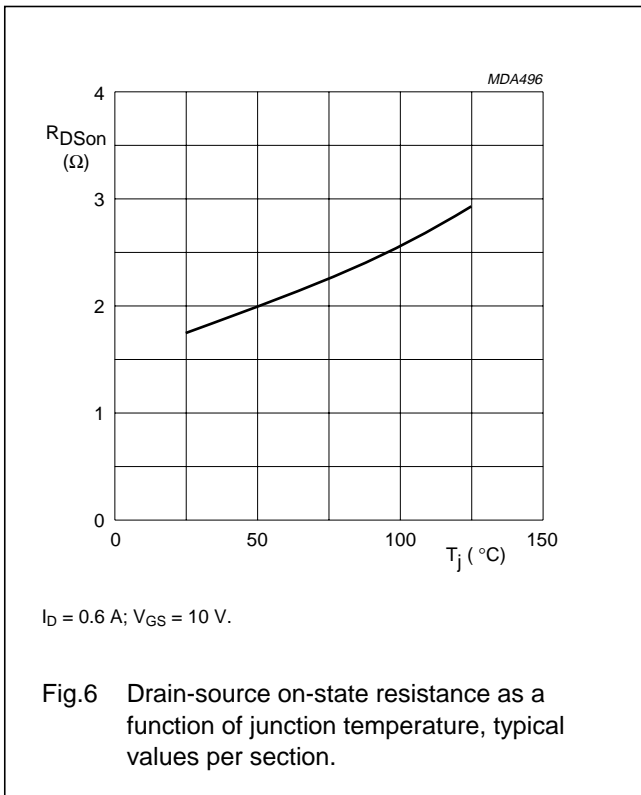

UHF push-pull power MOS transistor

BLF544B

APPLICATION INFORMATION FOR CLASS-B OPERATION

$T_h = 25\text{ }^\circ\text{C}$; $R_{th\text{ mb-h}} = 0.4\text{ K/W}$; unless otherwise specified.

RF performance in a push-pull, common source, class-B test circuit.

MODE OF OPERATION	f (MHz)	V _{DS} (V)	I _{DQ} (mA)	P _L (W)	G _p (dB)	η _D (%)
CW, class-B	500	28	2 × 20	20	> 12 typ. 15	> 50 typ. 60

Ruggedness in class-B operation

The BLF544B is capable of withstanding a load mismatch corresponding to VSWR = 50 through all phases, under the following conditions:

V_{DS} = 28 V, f = 500 MHz at rated output power.

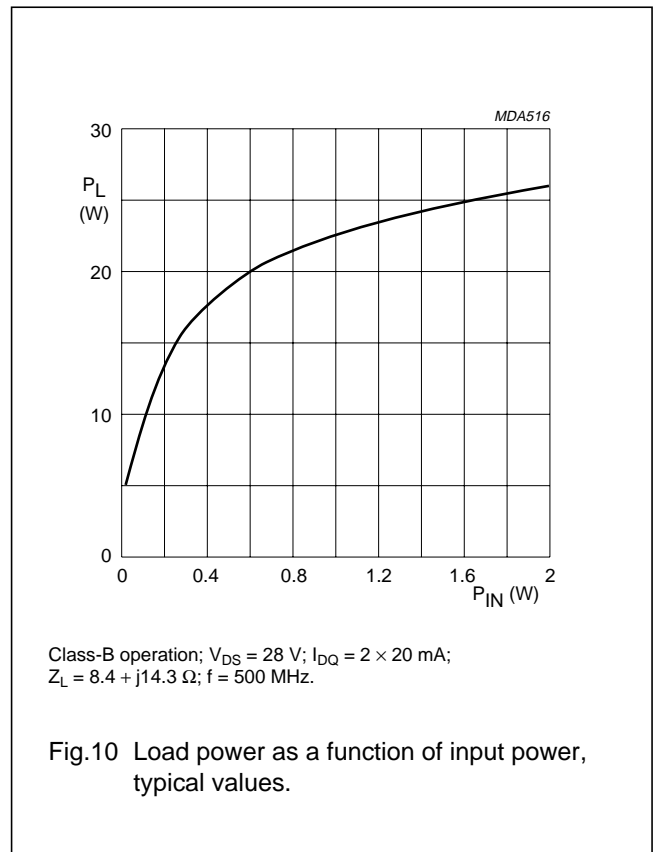
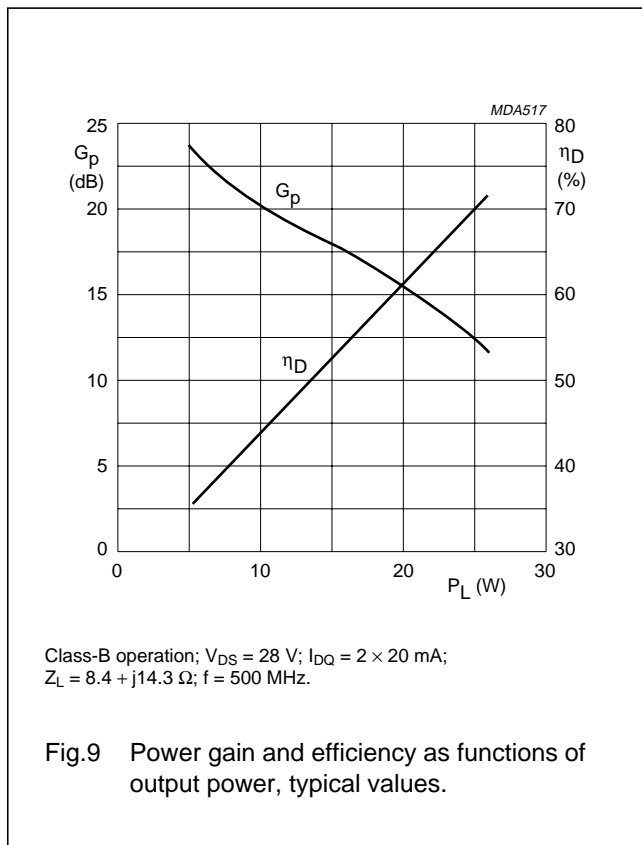

UHF push-pull power MOS transistor

BLF544B

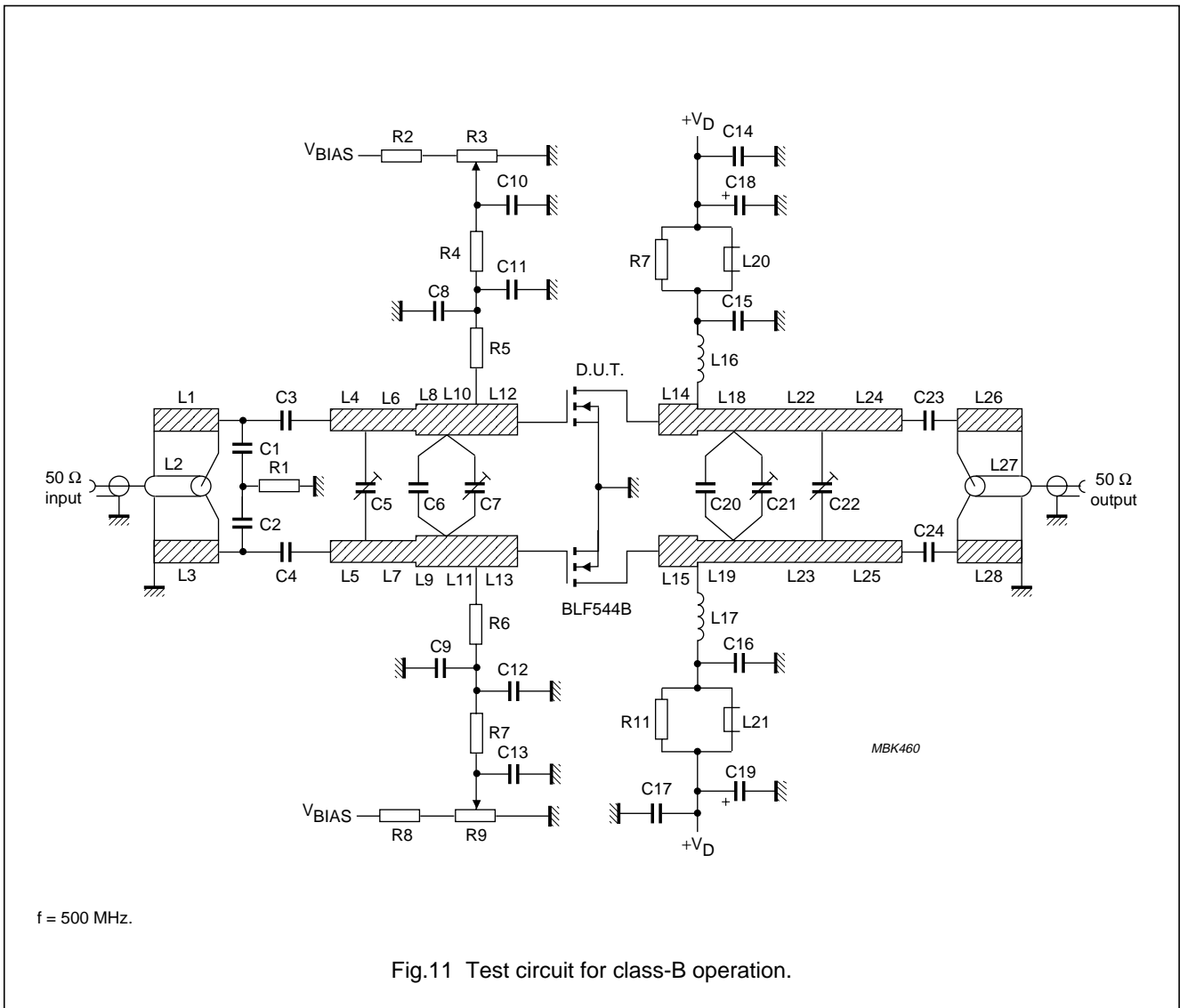

UHF push-pull power MOS transistor

BLF544B

List of components (class-B test circuit)

COMPONENT	DESCRIPTION	VALUE	DIMENSIONS	CATALOGUE NO.
C1, C2	multilayer ceramic chip capacitor (note 1)	9.1 pF, 500 V		
C3, C4, C6	multilayer ceramic chip capacitor (note 1)	18 pF, 500 V		
C5	film dielectric trimmer	2 to 9 pF		2222 809 09005
C7, C21, C22	film dielectric trimmer	2 to 18 pF		2222 809 09006
C8, C9, C15, C16	multilayer ceramic chip capacitor (note 1)	390 pF, 500 V		
C10, C13	multilayer ceramic chip capacitor	2 × 100 nF in parallel, 50 V		2222 852 47104
C11, C12, C14, C17	multilayer ceramic chip capacitor	100 nF, 50 V		2222 852 47104
C18, C19	electrolytic capacitor	10 µF, 63 V		2222 030 38109
C20	multilayer ceramic chip capacitor (note 1)	6.8 pF, 500 V		
C23, C24	multilayer ceramic chip capacitor (note 1)	16 pF, 500 V		
L1, L3, L26, L28	stripline (note 2)	50 Ω	56 × 2.4 mm	
L2	semi-rigid cable (note 3)	50 Ω	ext. dia. 2.2 mm ext. conductor length 56 mm	
L4, L5	stripline (note 2)	56 Ω	8 × 2 mm	
L6, L7	stripline (note 2)	56 Ω	15.5 × 2 mm	
L8, L9	stripline (note 2)	42 Ω	10 × 3 mm	
L10, L11	stripline (note 2)	42 Ω	5 × 3 mm	
L12, L13, L14, L15	stripline (note 2)	42 Ω	6 × 3 mm	
L16, L17	6 turns enamelled 1 mm copper wire	124 nH	length 8.5 mm int. dia. 5.4 mm leads 2 × 5 mm	
L18, L19	stripline (note 2)	56 Ω	22 × 2 mm	
L20, L21	grade 3B Ferroxcube RF choke			4312 020 36642
L22, L23	stripline (note 2)	56 Ω	18 × 2 mm	
L24, L25	stripline (note 2)	56 Ω	16 × 2 mm	
L27	semi-rigid cable (note 3)	50 Ω	ext. dia. 2.2 mm ext. conductor length 56 mm	
R1	0.4 W metal film resistor	5.62 Ω		2322 151 75628
R2, R8	0.4 W metal film resistor	11.5 kΩ		2322 151 71159
R3, R9	10 turns potentiometer	5 kΩ		
R4, R7	0.4 W metal film resistor	590 Ω		2322 151 75901
R5, R6	0.4 W metal film resistor	46.4 Ω		2322 151 74649
R10, R11	1 W metal film resistor	10 Ω		2322 153 51009

UHF push-pull power MOS transistor

BLF544B

Notes

1. American Technical Ceramics (ATC) capacitor, type 100B or other capacitor of the same quality.
2. The striplines are on a double copper-clad printed circuit board, with epoxy glass dielectric ($\epsilon_r = 2.2$), thickness $\frac{1}{32}$ inch.
3. Semi-rigid cables L2 and L27 are soldered on to striplines L1 and L26.

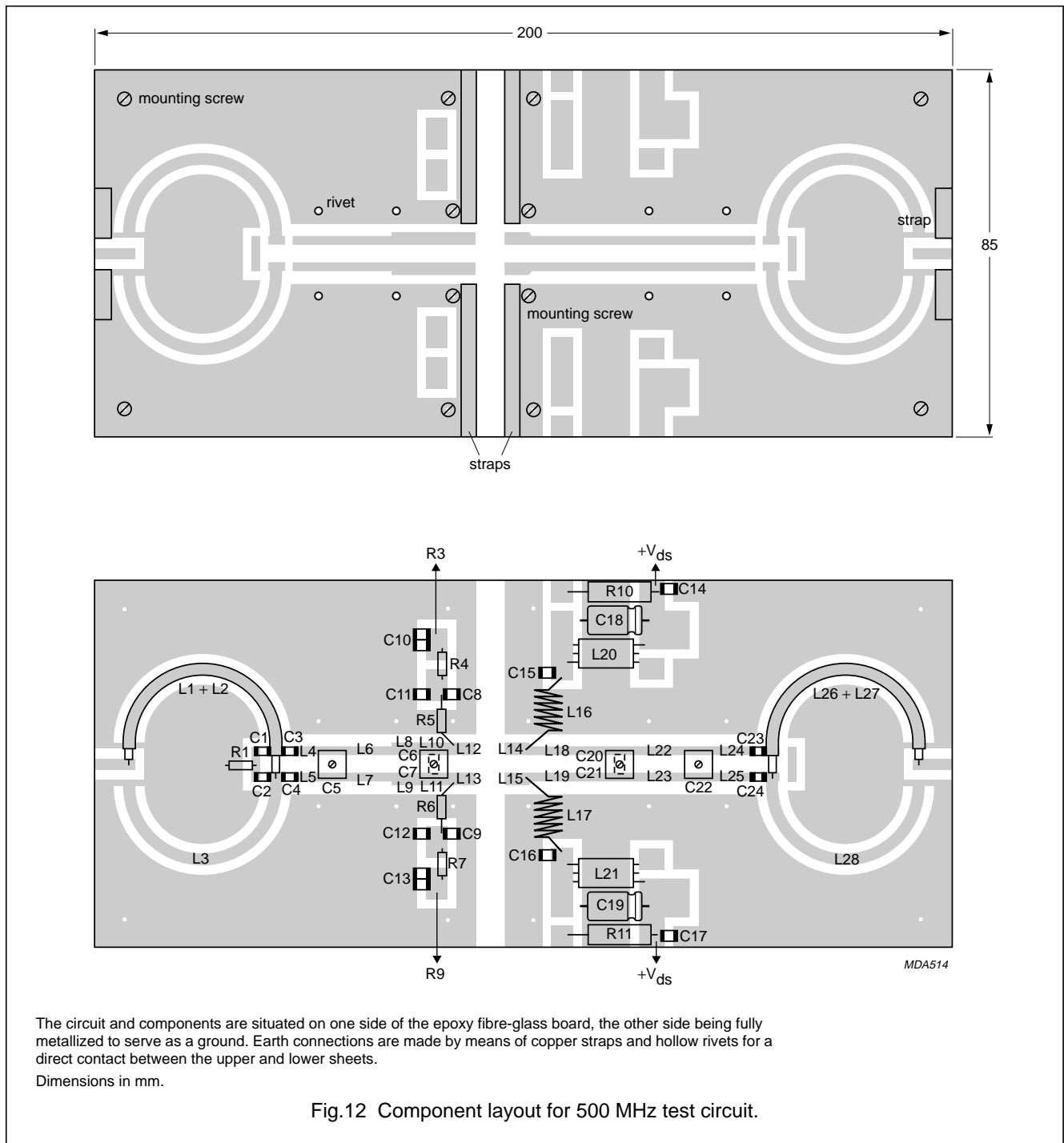

The circuit and components are situated on one side of the epoxy fibre-glass board, the other side being fully metallized to serve as a ground. Earth connections are made by means of copper straps and hollow rivets for a direct contact between the upper and lower sheets.
Dimensions in mm.

Fig.12 Component layout for 500 MHz test circuit.

UHF push-pull power MOS transistor

BLF544B

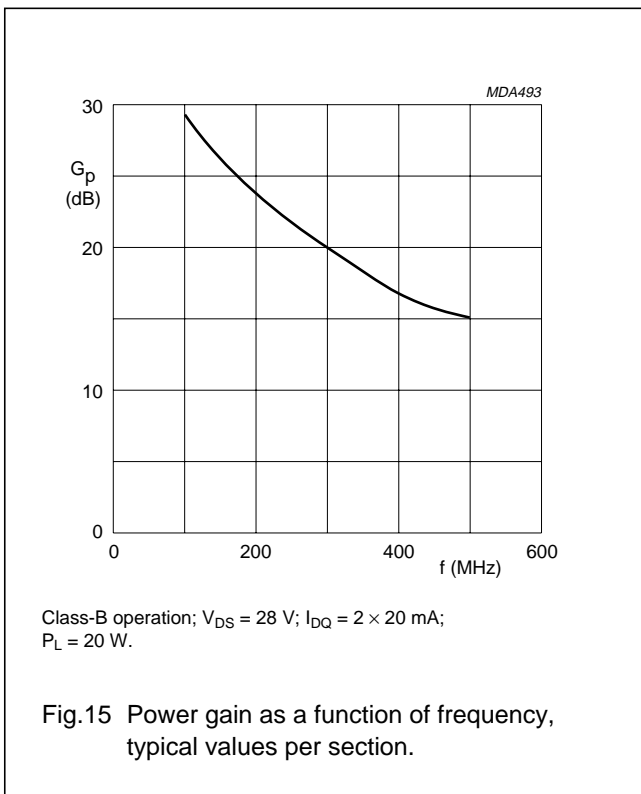
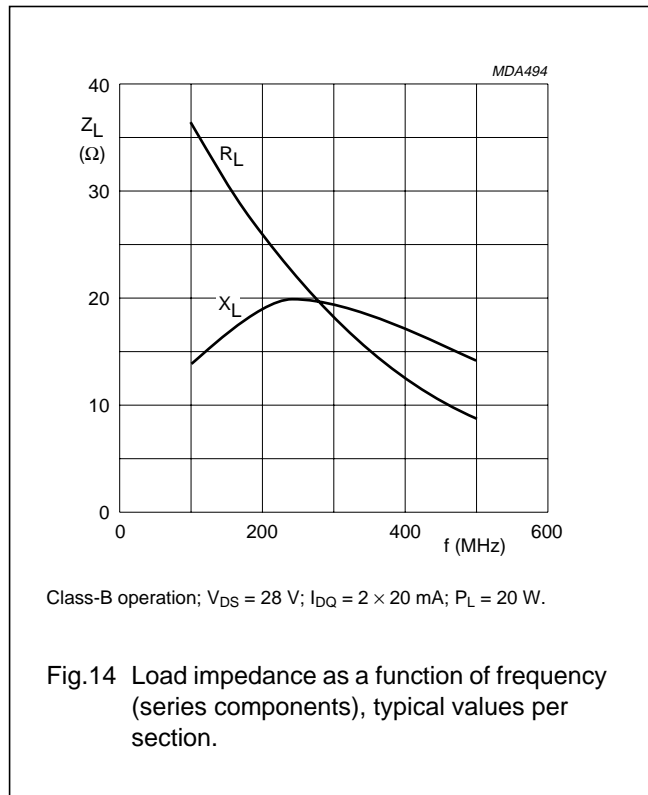
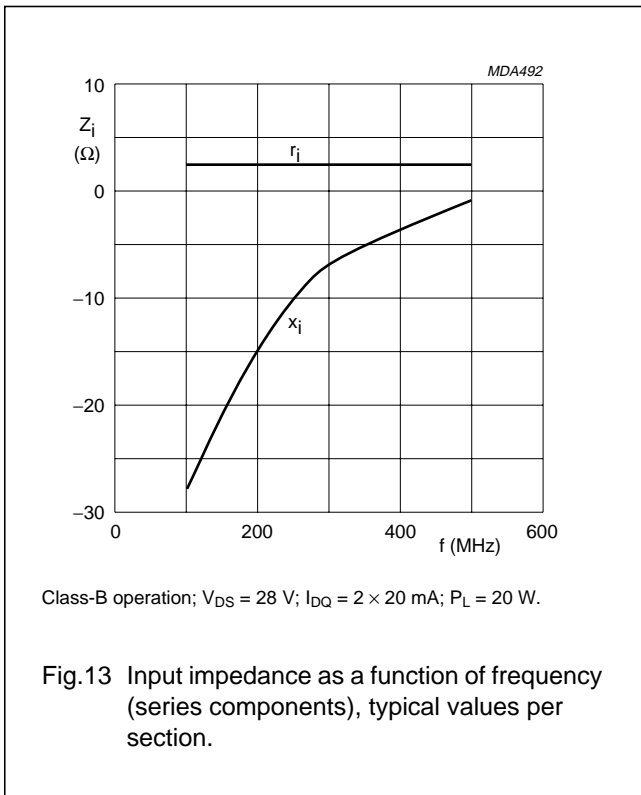

UHF push-pull power MOS transistor

BLF544B

PACKAGE OUTLINE

Flanged double-ended ceramic package; 2 mounting holes; 4 leads

SOT268A

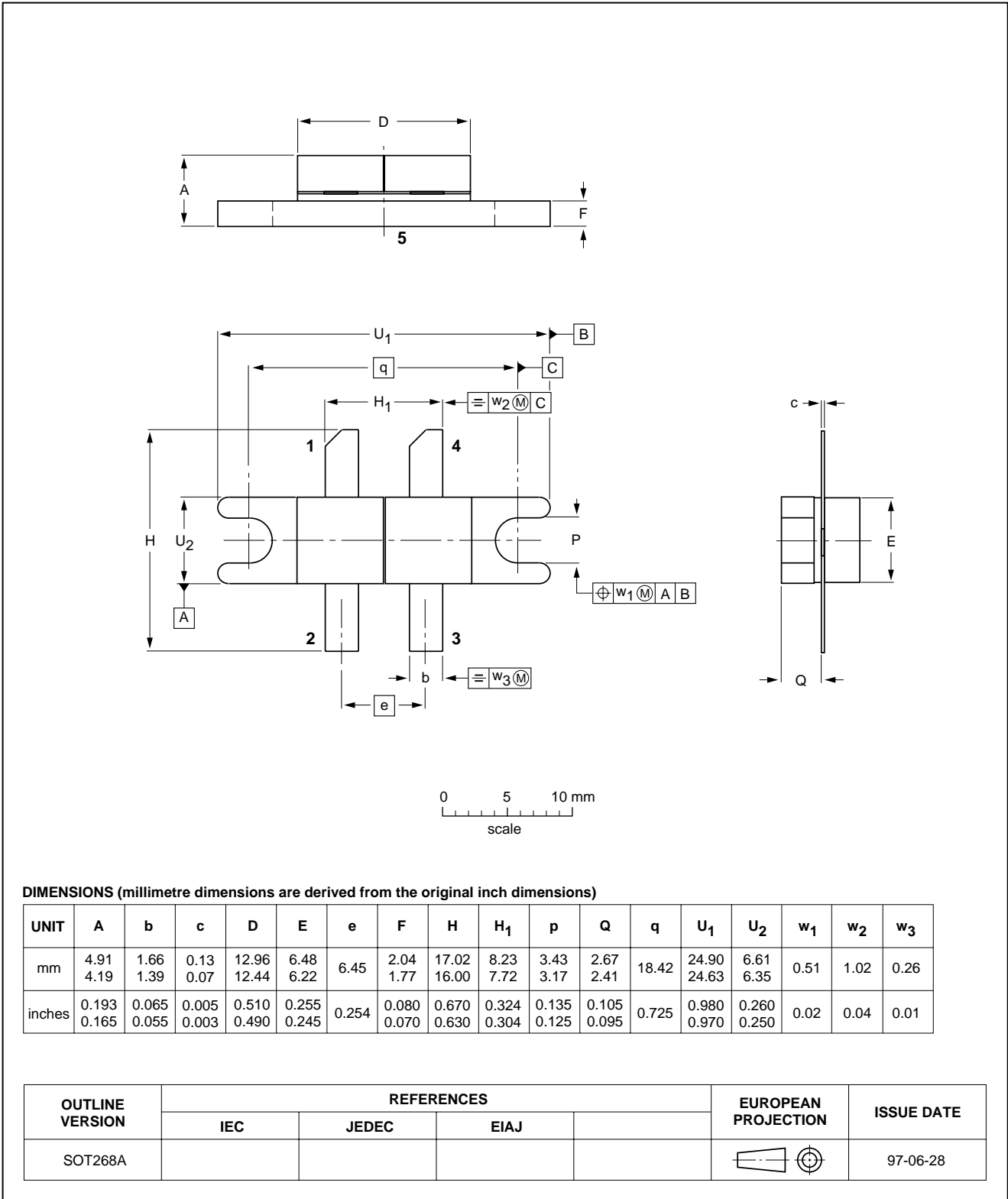

UHF push-pull power MOS transistor

BLF544B

DEFINITIONS

Data Sheet Status	
Objective specification	This data sheet contains target or goal specifications for product development.
Preliminary specification	This data sheet contains preliminary data; supplementary data may be published later.
Product specification	This data sheet contains final product specifications.
Limiting values	
Limiting values given are in accordance with the Absolute Maximum Rating System (IEC 134). Stress above one or more of the limiting values may cause permanent damage to the device. These are stress ratings only and operation of the device at these or at any other conditions above those given in the Characteristics sections of the specification is not implied. Exposure to limiting values for extended periods may affect device reliability.	
Application information	
Where application information is given, it is advisory and does not form part of the specification.	

LIFE SUPPORT APPLICATIONS

These products are not designed for use in life support appliances, devices, or systems where malfunction of these products can reasonably be expected to result in personal injury. Philips customers using or selling these products for use in such applications do so at their own risk and agree to fully indemnify Philips for any damages resulting from such improper use or sale.