

# DATA SHEET

## **BLV12** VHF power transistor

Product specification

September 1991

# VHF power transistor

# BLV12

### FEATURES

- Emitter-ballasting resistors for an optimum temperature profile
- Excellent reliability
- Withstands full load mismatch.

### DESCRIPTION

NPN silicon planar epitaxial transistor encapsulated in a 4-lead SOT123 flange envelope with a ceramic cap. It is designed for common emitter, class-B operation in mobile VHF transmitters with a supply voltage of 12.5 V. All leads are isolated from the mounting flange.

### PINNING - SOT123

PIN	DESCRIPTION
1	collector
2	emitter
3	base
4	emitter

### QUICK REFERENCE DATA

RF performance at  $T_{mb} = 25\text{ }^{\circ}\text{C}$  in a common emitter test circuit.

MODE OF OPERATION	f (MHz)	V <sub>CE</sub> (V)	P <sub>L</sub> (W)	G <sub>p</sub> (dB)	η <sub>c</sub> (%)
c.w. class-B	175	12.5	30	> 9	> 60

### WARNING

#### Product and environmental safety - toxic materials

This product contains beryllium oxide. The product is entirely safe provided that the BeO disc is not damaged. All persons who handle, use or dispose of this product should be aware of its nature and of the necessary safety precautions. After use, dispose of as chemical or special waste according to the regulations applying at the location of the user. It must never be thrown out with the general or domestic waste.

### PIN CONFIGURATION

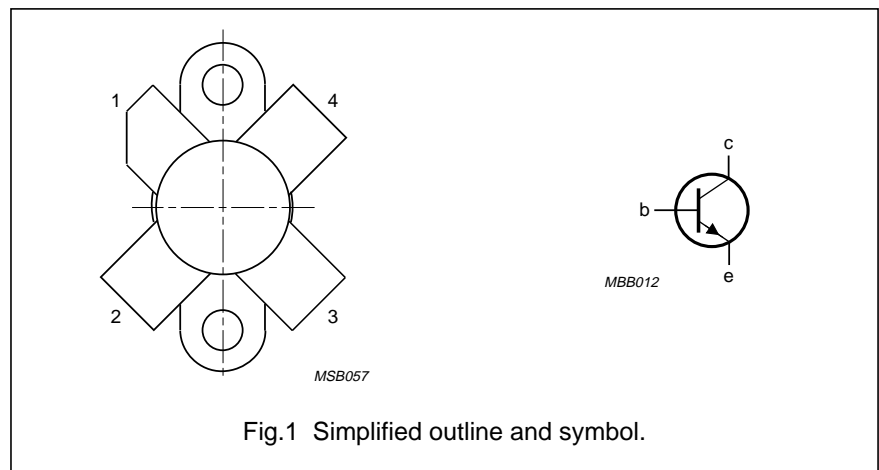

VHF power transistor

BLV12

**LIMITING VALUES**

In accordance with the Absolute Maximum System (IEC 134).

SYMBOL	PARAMETER	CONDITIONS	MIN.	MAX.	UNIT
$V_{CBO}$	collector-base voltage	open emitter	–	36	V
$V_{CEO}$	collector-emitter voltage	open base	–	16	V
$V_{EBO}$	emitter-base voltage	open collector	–	3	V
$I_C, I_{C(AV)}$	collector current	DC or average value	–	6	A
$I_{CM}$	collector current	peak value $f > 1$ MHz	–	18	A
$P_{tot}$	total power dissipation	RF operation; $f > 1$ MHz; $T_{mb} = 25$ °C	–	100	W
$T_{stg}$	storage temperature range		–65	150	°C
$T_j$	junction operating temperature		–	200	°C

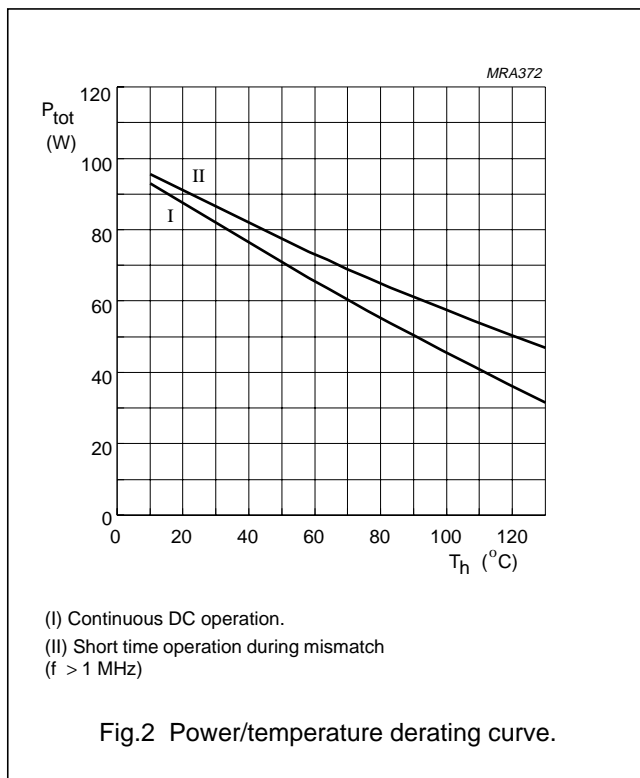

**THERMAL RESISTANCE**

SYMBOL	PARAMETER	CONDITIONS	MAX.	UNIT
$R_{th\ j-mb(RF)}$	from junction to mounting base	$P_{tot} = 100$ W; $T_{mb} = 25$ °C	1.75	K/W
$R_{th\ mb-h}$	from mounting base to heatsink		0.3	K/W

VHF power transistor

BLV12

**CHARACTERISTICS**

$T_j = 25\text{ }^\circ\text{C}$ .

SYMBOL	PARAMETER	CONDITIONS	MIN.	TYP.	MAX.	UNIT
$V_{(BR)CBO}$	collector-base breakdown voltage	open emitter; $I_c = 10\text{ mA}$	36	–	–	V
$V_{(BR)CEO}$	collector-emitter breakdown voltage	open base; $I_c = 25\text{ mA}$	16	–	–	V
$V_{(BR)EBO}$	emitter-base breakdown voltage	open collector; $I_E = 2\text{ mA}$	3	–	–	V
$I_{CES}$	collector-emitter leakage current	$V_{BE} = 0$ ; $V_{CE} = 16\text{ V}$	–	–	10	mA
$h_{FE}$	DC current gain	$V_{CE} = 5\text{ V}$ ; $I_C = 4\text{ A}$	25	35	–	
$f_T$	transition frequency	$V_{CE} = 12.5\text{ V}$ ; $I_E = 4\text{ A}$ ; $f = 500\text{ MHz}$	–	1.6	–	GHz
$C_c$	collector capacitance	$V_{CB} = 12.5\text{ V}$ ; $I_E = I_e = 0$ ; $f = 1\text{ MHz}$	–	90	100	pF
$C_{re}$	feedback capacitance	$V_{CE} = 12.5\text{ V}$ ; $I_C = 0$ ; $f = 1\text{ MHz}$	–	60	70	pF
$C_{c-f}$	collector-flange capacitance	$f = 1\text{ MHz}$	–	2	–	pF

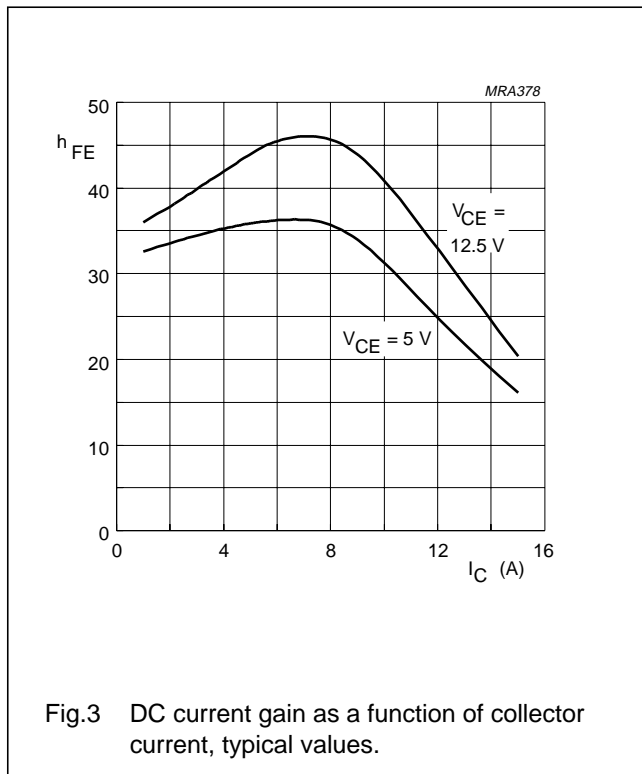
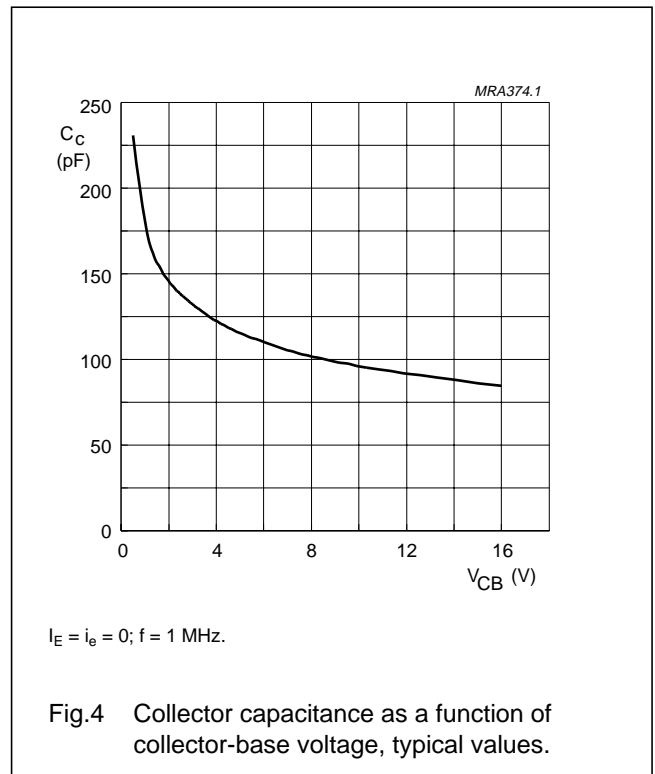

Fig.3 DC current gain as a function of collector current, typical values.



$I_E = I_e = 0$ ;  $f = 1\text{ MHz}$ .

Fig.4 Collector capacitance as a function of collector-base voltage, typical values.

VHF power transistor

BLV12

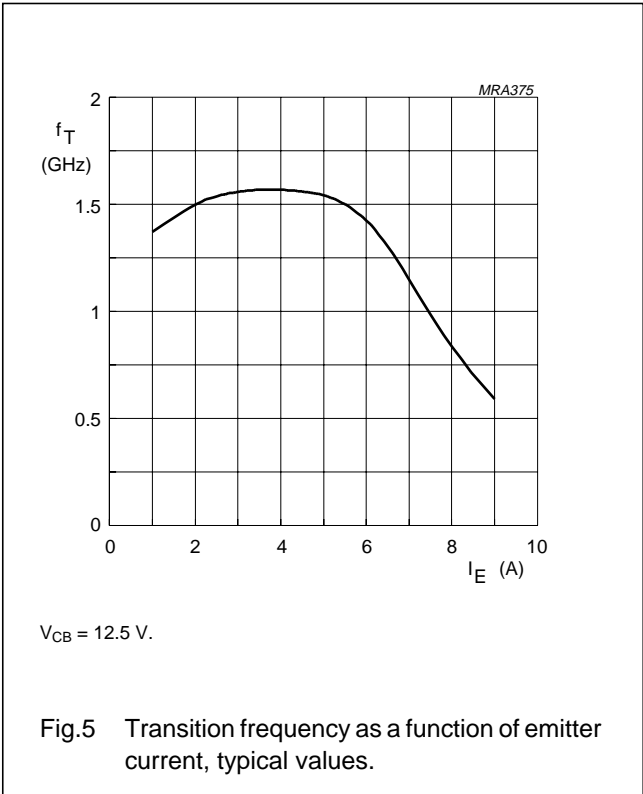

VHF power transistor

BLV12

**APPLICATION INFORMATION**

RF performance at  $T_{mb} = 25\text{ }^{\circ}\text{C}$  in a common emitter test circuit.

MODE OF OPERATION	f (MHz)	V <sub>CE</sub> (V)	P <sub>L</sub> (W)	G <sub>P</sub> (dB)	η <sub>c</sub> (%)
c.w. class-B	175	12.5	30	> 9 typ. 9.8	> 60 typ. 66

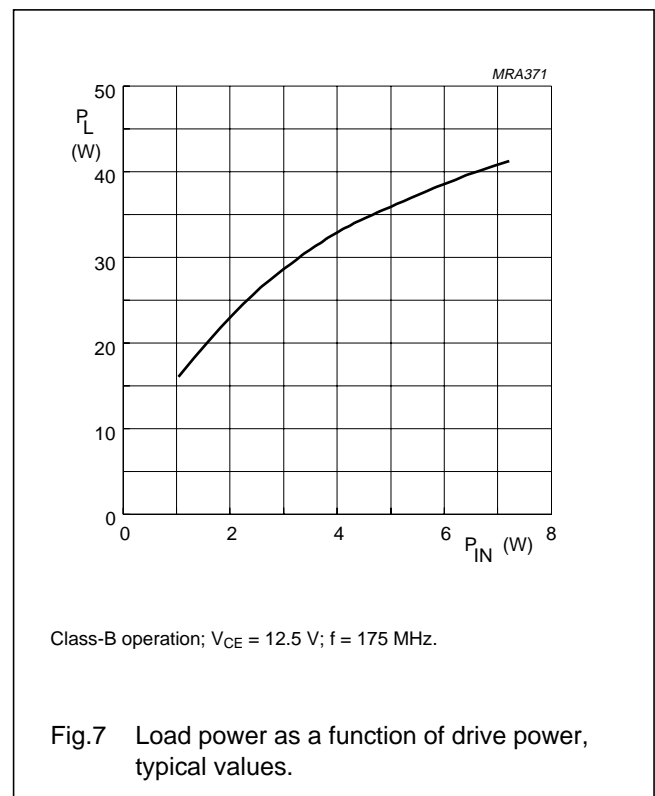
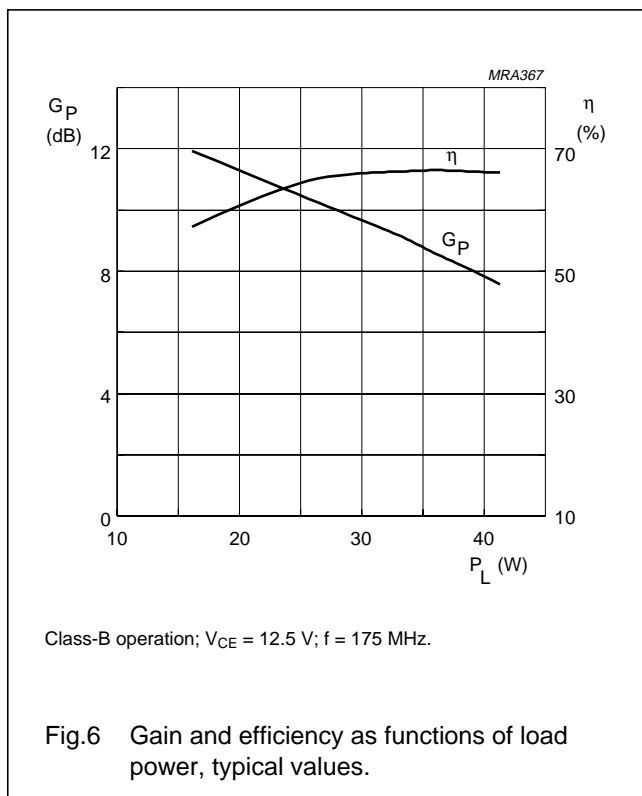

**Ruggedness in class-B operation**

The BLV12 is capable of withstanding a full load mismatch corresponding to VSWR = 50:1 through all phases at rated output power, up to a supply voltage of 15.5 V, and f = 175 MHz.

## VHF power transistor

BLV12

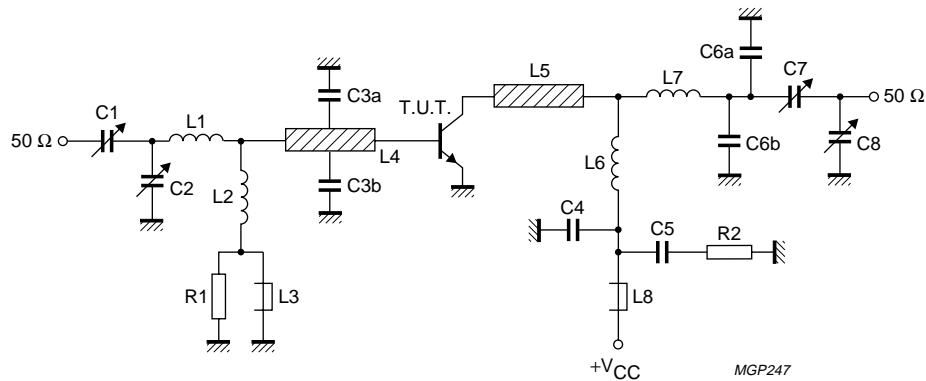
Fig.8 Class-B test circuit at  $f = 175$  MHz.

## List of components (see test circuit)

COMPONENT	DESCRIPTION	VALUE	DIMENSIONS	CATALOGUE NO.
C1	film dielectric trimmer	2.5 to 20 pF		2222 809 07004
C2, C8	film dielectric trimmer	4 to 40 pF		2222 809 07008
C3a, C3b	500 V ceramic capacitor	47 pF		
C4	500 V ceramic capacitor	120 pF		
C5	polyester capacitor	100 nF		
C6a, C6b	500 V ceramic capacitor	8.2 pF		
C7	film dielectric trimmer	5 to 60 pF		2222 809 07011
L1	1 turn enamelled 1.6 mm copper wire		int. dia. 9 mm; leads $2 \times 5$ mm	
L2	7 turns closely wound enamelled 0.5 mm copper wire	100 nH	int. dia. 3 mm; leads $2 \times 5$ mm	
L3, L8	grade 3B Ferroxcube wideband HF choke			4312 020 36640
L4, L5	stripline (note 1)		12 mm $\times$ 6 mm; note 2	
L6	2 turns enamelled 1.6 mm copper wire		int. dia. 5 mm; length 6 mm; leads $2 \times 5$ mm	
L7	2 turns enamelled 1.6 mm copper wire		int. dia. 4.5 mm; length 6 mm; leads $2 \times 5$ mm	
R1	0.25 W carbon resistor	10 $\Omega$ , 5%		
R2	0.25 W carbon resistor	4.7 $\Omega$ , 5%		

## Notes

1. The striplines are on a double copper-clad printed circuit board, with epoxy fibre-glass dielectric, thickness  $\frac{1}{16}$  inch.
2. Taps for capacitors C3a and C3b are situated 5 mm from the transistor.

VHF power transistor

BLV12

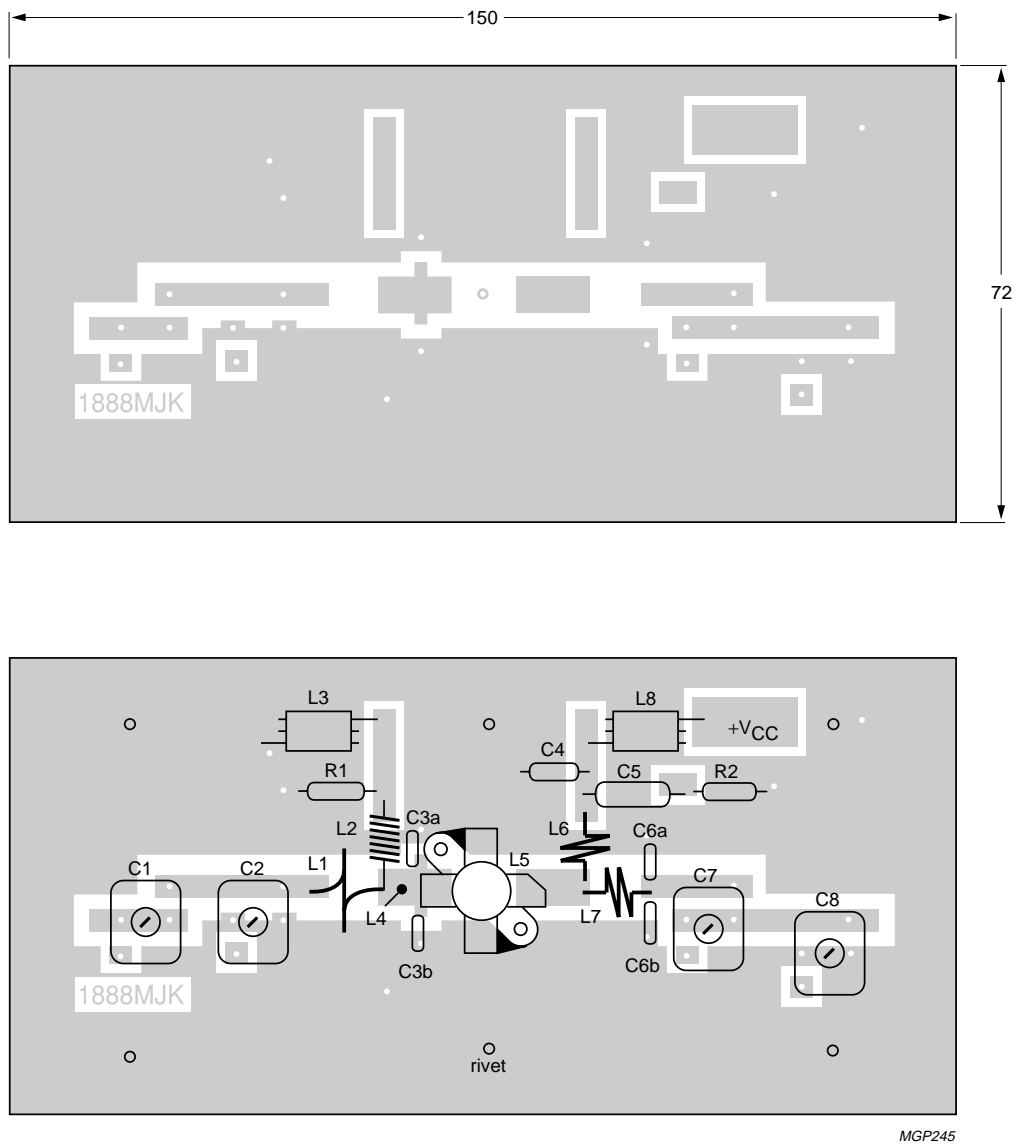

The circuit and components are situated on one side of an epoxy fibre-glass board; the other side is unetched and serves as a ground plane. Earth connections are made by means of hollow rivets and copper straps under the emitters, to provide a direct contact between the component side and the ground plane.

Fig.9 Component layout for 175 MHz class-B test circuit.



VHF power transistor

BLV12

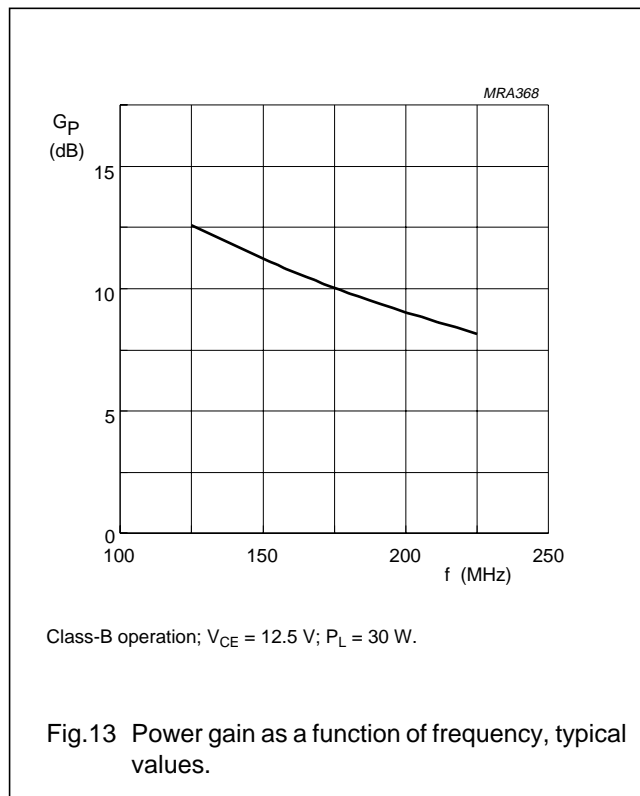
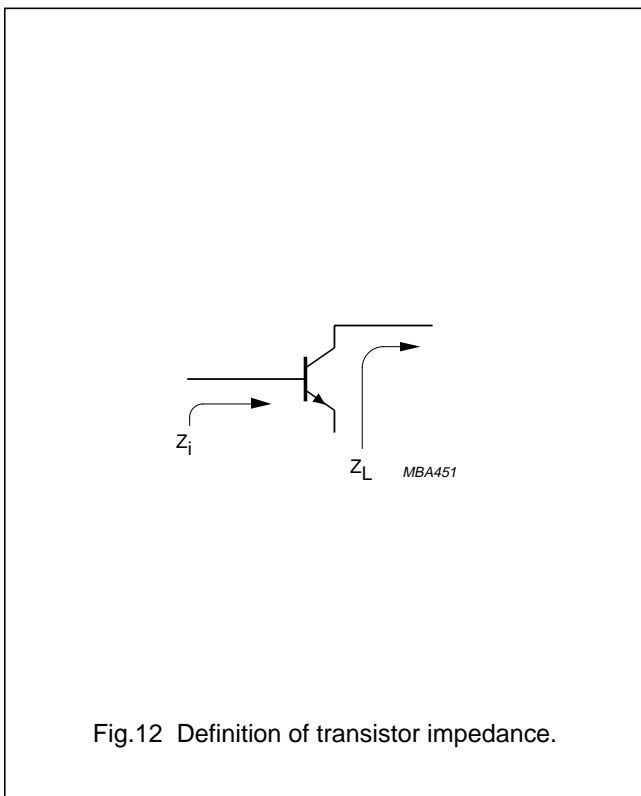
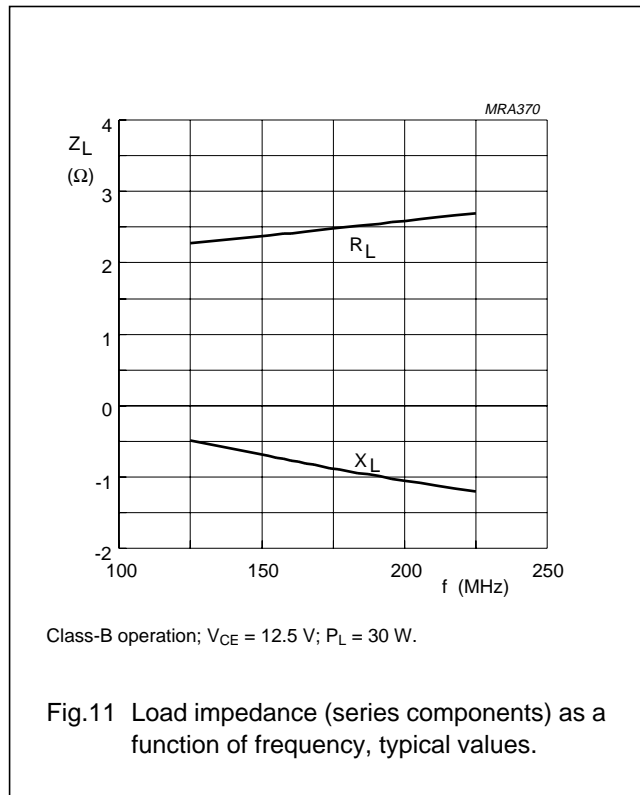
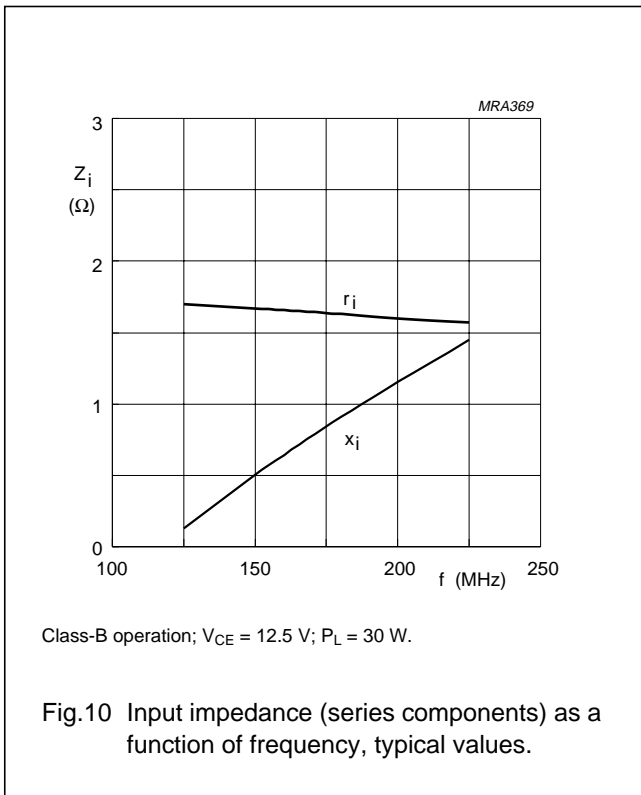

VHF power transistor

BLV12

PACKAGE OUTLINE

Flanged ceramic package; 2 mounting holes; 4 leads

SOT123A



DIMENSIONS (millimetre dimensions are derived from the original inch dimensions)

UNIT	A	b	c	D	D <sub>1</sub>	F	H	L	p	Q	q	U <sub>1</sub>	U <sub>2</sub>	U <sub>3</sub>	w <sub>1</sub>	w <sub>2</sub>	α
mm	7.47 6.37	5.82 5.56	0.18 0.10	9.73 9.47	9.63 9.42	2.72 2.31	20.71 19.93	5.61 5.16	3.33 3.04	4.63 4.11	18.42	25.15 24.38	6.61 6.09	9.78 9.39	0.51	1.02	45°
inches	0.294 0.251	0.229 0.219	0.007 0.004	0.383 0.373	0.397 0.371	0.107 0.091	0.815 0.785	0.221 0.203	0.131 0.120	0.182 0.162	0.725	0.99 0.96	0.26 0.24	0.385 0.370	0.02	0.04	

OUTLINE VERSION	REFERENCES				EUROPEAN PROJECTION	ISSUE DATE
	IEC	JEDEC	EIAJ			
SOT123A						97-06-28

## VHF power transistor

BLV12

**DEFINITIONS**

<b>Data Sheet Status</b>	
Objective specification	This data sheet contains target or goal specifications for product development.
Preliminary specification	This data sheet contains preliminary data; supplementary data may be published later.
Product specification	This data sheet contains final product specifications.
<b>Limiting values</b>	
Limiting values given are in accordance with the Absolute Maximum Rating System (IEC 134). Stress above one or more of the limiting values may cause permanent damage to the device. These are stress ratings only and operation of the device at these or at any other conditions above those given in the Characteristics sections of the specification is not implied. Exposure to limiting values for extended periods may affect device reliability.	
<b>Application information</b>	
Where application information is given, it is advisory and does not form part of the specification.	

**LIFE SUPPORT APPLICATIONS**

These products are not designed for use in life support appliances, devices, or systems where malfunction of these products can reasonably be expected to result in personal injury. Philips customers using or selling these products for use in such applications do so at their own risk and agree to fully indemnify Philips for any damages resulting from such improper use or sale.